



APM TECHNOLOGIES

PROFESSIONAL INNOVATIVE BRANDING SERVICE

en.apmtech.cn

SP-1U/2U Series High Performance Programmable DC Power Supply

User Manual >>>



Contents

Preface	4
Safety Notices	5
1 About this Manual	6
1.1 Scope	6
1.2 Targeted Audience	6
1.3 Use of this Manual and Legal Notices	6
2 Unpacking	7
2.1 Packing List	7
2.2 Checking for Shipping Damage	8
3 Products Introduction	8
3.1 Product Description	8
3.2 Product Features	9
3.3 Operation Instructions	9
3.4 Operation Environments	9
3.5 Product Storage	10
3.6 Maintenance and Cleaning	10
3.7 Power Supply Voltage	10
3.8 Fuse	10
3.9 Warm-up Time	11
3.10 Unit Shutdown	11
3.11 Operation Precautions	11
3.12 Starting Procedure	11

4 Operation	13
4.1 Front Panel Description	13
4.1.1 Description of Functional Keys	13
4.1.2 Description of Multifunctional Keys	14
4.1.3 Introduction to Front Panel Operations	14
4.1.4 Front Panel Operations	14
4.1.5 Store and Recall Operation	15
4.1.6 Menu Operation	16
4.1.7 SYSTEM SETTING	17
4.1.8 OUTPUT SETTING	25
4.1.9 INFORMATION	28
4.1.10 PROTECTION Setting	28
4.1.11 SERIES/PARALLEL Setting	31
4.1.12 TIME CONTROL	35
4.1.13 SPECIAL TEST FUNC.....	36
4.1.14 ADDITIONAL FUNC.....	41
4.2 Rear Panel	44
4.2.1 Input Connections	45
4.2.2 Load Connections	48
4.2.3 Remote Compensation	49
4.2.4 DVM Function	50
5 Applications	51
5.1 External Setting	51
5.2 Timer Control Function	51
5.3 SHORT MODE Function	52
5.4 Master-slave Mode Configuration	54
5.5 List Function	55

6 Introduction to Software 56

 6.1 Software Installation 56

7 Troubleshooting 57

8 Installation 58

 8.1 Product Dimensions 58

 8.2 Shelf Mounting Diagram of DC Power Supply 58

 8.3 Assemble Rack Mount Brackets 59

9 Recycling and Disposal 60

10 Contact Us 60

Appendix A Specifications 61

Appendix B Web Server 75

Appendix C Warranty 79

Appendix D Anti reverse irrigation/Power Sink Function.....82

Preface

Dear Customer,

Thank you for using SP-1U/2U Series High Performance Programmable DC Power Supply, a product developed & manufactured by APM Technologies. We sincerely hope that this product will meet your needs.

The sections outlined in this user manual are suitable for the following product models:

<div style="display: flex; align-items: center;"> <div style="margin-right: 5px;">□</div> <div style="margin-right: 5px;">○</div> <div style="margin-left: 5px;">Power</div> </div>	1U Units					2U Units			
	Voltage	600W	1000W	1200W	1500W	1600W	1000W	2000W	3000W
20VDC	60A ^[2]	60A ^[2]	60A ^[2]	-	-	-	-	-	-
32VDC	50A ^[2]	50A ^[2]	50A ^[2]	-	50A ^[2]	200A ^[1]	200A	200A	200A
40VDC	40A ^[2]	40A ^[2]	40A ^[2]	-	40A ^[2]	120A ^[1]	120A	120A	120A
75VDC	25A ^[2]	25A ^[2]	25A ^[2]	25A ^[2]	-	-	-	-	60A
80VDC	-	-	-	-	-	60A ^[1]	60A	60A	-
120VDC	-	-	-	-	-	40A ^[1]	40A	40A	40A
150VDC	10A ^[2]	10A ^[2]	10A ^[2]	10A ^[2]	-	30A ^[1]	30A	30A	30A
200VDC	8A ^[2]	8A ^[2]	8A ^[2]	8A ^[2]	-	24A ^[1]	24A	24A	24A
600VDC	-	-	-	-	-	10A ^{[1][2]}	10A ^[2]	10A ^[2]	10A ^[2]
800VDC	-	-	-	-	-	7.5A ^{[1][2]}	7.5A ^[2]	7.5A ^[2]	7.5A ^[2]

Model guide

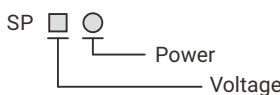

For example: SP200VDC1500W
Note: SP stands for Switching Power.

^[1] Model guide

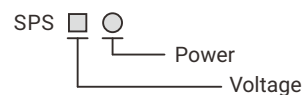

^[2] For these models, the DVM and Analog input functions is optional.

Version D, updated May 2021

Safety Notices



This symbol highlights operations that have the potential to endanger users, operation procedures and instructions must be absolutely understood before use.



This symbol highlights precautions users need to take to avoid potential injury during equipment operation.



This symbol highlights important instructions that need to be read before using the equipment.



This symbol indicates of high voltage risk aspects of the product or its use.



This symbol indicates parts that may be at a high temperature. Please do not touch this part of the equipment to prevent scalding.



This symbol indicates that a grounded condition is required before operating the equipment; the terminal with this label must be grounded to prevent electric shock.

About this Manual

1.1 Scope

This manual provides the reader with detailed product information as well as installation, operation and maintenance instructions. This manual also provides our company contact information so that you can tell us your suggestions and comments about the performance of our products in order that we can continue to improve our product quality and our level of service.

1.2 Targeted Audience

This manual is intended for product users and technical personnel that are involved with installing, operating and maintaining the product. Readers are required to have a certain degree of electrical and mechanical knowledge and be familiar with basic electrical and mechanical schematics.

1.3 Use of this Manual and Legal Notices

All materials (including but not limited to graphics, logos, symbols, data, etc.) in this manual are owned by the APM Technologies. No part of this manual can be reproduced without prior authorization from APM Technologies.

The content of this manual will continue to be updated and revised as inevitably there are slight discrepancies or errors. Please check for updates at www.apmtech.cn and download the latest version of this manual and information.

It is prohibited in any way to use all or part of the firmware or software developed by APM Technologies for other commercial purposes. It is prohibited to decompile, decrypt or otherwise damage the software developed by APM Technologies.

2 Unpacking

2.1 Packing List

Item	Descriptions	Quantity	Remarks
A	SP-1U/2U Series Programmable DC Power Supply	1	As ordered
B	Rack Mount Brackets	2	Standard
C	Input Terminal Cover Box & Screws	1	Standard(applicable in 2U)
D	Screws	6	Standard
E	Power Cord ^[1]	1	Standard
F	Three-pin Plug Power Cord(10A or 16A) ^[2]	1	Standard
G	RS-232 Communication Cable	1	Standard
H	LAN Communication Cable (568A-568B)	1	Standard
	LAN Communication Cable (568A-568A)	1	Standard
I	USB Communication Cable	1	Standard
J	GPIB Communication Cable	1	Optional
K	Current Sharing Cable	1	Standard
L	System Bus Communication Cable	1	Standard
M	Front/Rear Pads(applicable in 1U)	each 2	Standard
N	Pads(applicable in 2U)	4	Standard
O	Quick Guide	1	Standard

[1] Only 600W model is standard with three-pin plug power cable (16A), The rest models are equipped with power cable(1.5M).

[2] Please make sure that the input voltage and current range meets the requirements of this cable before connecting, Otherwise the power cord may burn out.

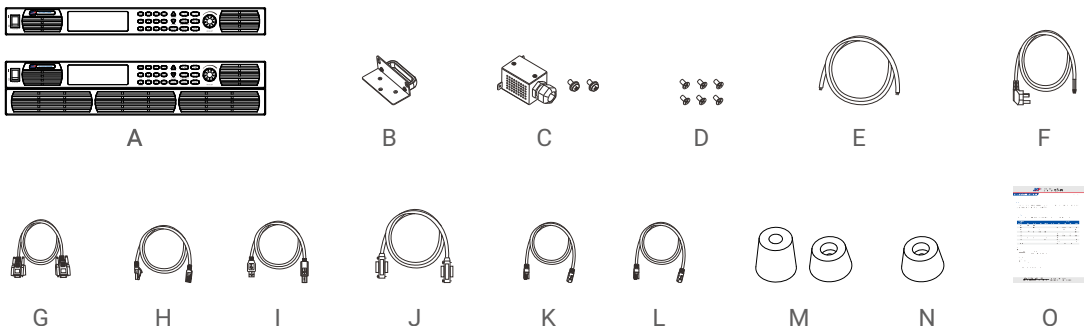

2.2 Checking for Shipping Damage

All APM Technologies Company products have undergone stringent testing before delivery, but inevitably damage can happen during transportation. Once you receive the product, please immediately check if there is any packaging damage that may indicate damage to the product. If you find damage related to product delivery, please immediately notify the transport company. Make sure to take photos documenting the damage to the product, and send them to us so that we can provide you with the best service.



Caution!

- The handles on the front panel are for sliding in and out of the cabinet NOT for carrying.
- Because of its weight, transport by hand should be avoided where possible. If unavoidable then only the housing should be held and not on the exterior parts (handles, input/output terminals or rotary knobs).



3 Products Introduction

3.1 Product Description

The SP Series DC Power Supplies with single outputs, 1U/2U (rack unit) high, switching power supplies. With a 16-bit D/A, 24-bit A/D sampling circuits.

All models have parallel master/slave operation capability with active current sharing, which allows parallel connection of units with accurate current sharing. As well as series connection of up to 10 units.

The front panel settings allow users to easily set up the output parameters, over voltage protection (OVP), over current protection (OCP), and over power protection (OPP) levels, and preview the settings.

Additionally, the power supplies provide a memory space of 9 instrument settings that can be recalled, as well as a memory space of 9 instrument settings that can be recalled directly.

The rear panel includes the necessary connectors to control and monitor the power supply operation by analog signals or by the built-in remote communication interfaces.

3.2 Product Features

- Worldwide input voltage range, high power density.
- Master/slave parallel & series operation modes for up to 10 units.
- Precision voltage and current measurement via high-speed programmable interface.
- Optically coded knob and multi-function keyboard allow programming Constant Current (CC) and Constant Voltage (CV) modes.
- Voltage rate of rise and drop functions.
- Programmable multi-step settings for output voltage, current, Over Voltage Protection (OVP), Over Current Protection (OCP), Over Power Protection (OPP), and thermal protection (OTP).
- USB / LAN / RS485 / RS232 interfaces using SCPI standard communication protocol.
- Standard analog external remote inputs.
- Remote voltage sensing inputs to compensate for voltage drop to the load.
- Independent DVM output measuring function with inputs.

3.3 Operating Instructions

This product is a precision instrument, please read this manual carefully before use. In order to ensure measurement accuracy it is recommended that a calibration check be performed on this product every year.

3.4 Operating Environments

1. These power supplies must be used in a clean and dry laboratory or testing environment with an ambient temperature of between 0°C and 40°C and a relative humidity of between 10% and 90%.
2. Do not prolong the use of this power supply in a high temperature ambient.
3. Fans cool the power supply by drawing air through the front and exhausting it out the back. Please assure that 20 cm space is present at the front and back of the unit for adequate air circulation.
4. Do not operate this product in an environment that contains large amounts of dust, is subject to strong shock and vibration, is in intense direct sunlight or contains corrosive gases.

3.5 Product Storage

Please store this product in an area with a temperature between -20 °C and 70 °C and with a relative humidity of between 0% and 90% non-condensing. If the product is not in use for a long time, please keep it in the original carton or other similar packaging and store it in a cool & dry place.

3.6 Maintenance and Cleaning

Before cleaning, you must disconnect the input power cord of this power supply. Using a brush or sponge, gently wipe off any dust from the units exterior. To clean the products exterior use only a small amount of non-aqueous cleaning solution such as isopropyl alcohol on a clean cloth. Do not use a corrosive or abrasive cleaning solution to clean this product. The display front panel can be cleaned with gauze damped in soft detergent. Cleaning of dust from the interior of this product must be carried out with a low pressure air gun, and we prefer that such a clean work be performed by an authorized dealer on behalf of the user.

3.7 Power Supply Voltage

Make sure that the AC input voltage is within the product's operating specification before plugging in or connecting to the source, and that the power switch is in the OFF state.



Caution!

- The protective safety earth/ground connection must connect first and disconnect after the AC line and neutral wires. All approved AC power connectors are designed to meet this requirement. If the input wires are directly connected to an AC mains circuit assure that the AC source is deactivated prior to making or disconnecting the connection.

3.8 Fuse

The AC mains fuses installed inside the product are designed to protect the input from major failures, and should not fail under normal operating conditions. Therefore, any sign of fuse failure is an indication that other part(s) of the product is damaged. If fuse melting happens, we recommend that the product be sent back to us for repair.



Warning!

- No user serviceable components enclosed. Do not disassemble the power's enclosure /case to replace the fuse, as there is a danger of sustaining an electric shock.

3.9 Warm-up Time

Once the power supply is switched on, all features of the unit are operable after the start routine has completed. However in order to achieve the specified operating accuracy, please allow the power supply to operate for a warm-up time of 30 minutes.

3.10 Unit Shutdown

When you no longer need to use this product, please make sure the front panel power switch is set to the "OFF" state. After the AC power is switched off the internal fan will continue to run for a few seconds to allow the internal capacitors to discharge. When discharging is completed, the unit will automatically shut down.

3.11 Operation Precautions

1. When the unit is first turned on the DC output is in a deactivated state. It can be activated by pressing the output turn on push button on the front panel or by remote control command.
2. Before turning on the DC power output, check that all the setting values of the power supply are in accordance with the load requirements.

3.12 Starting Procedure

Plug in the DC power and turn on the power switch on the front panel, the programmable DC power supply will execute a self-checking routine:

The company name APM Technologies will appear on the front panel display:

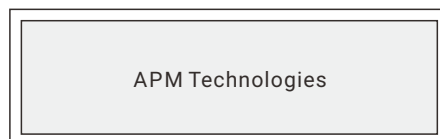

After 1 second, it enters the self-testing (self-checking) mode;

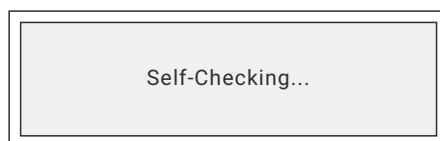

The power supply firmware will perform a series of tests checking memory, communications and other functions. When the self-checking procedure is completed, the front panel display will automatically display the main screen:

00.0000V	00.0000A	OFF
00.0000V	61.0000A	

The first row will display the internal voltage measured value, current measured value and the operating mode of the programmable DC power. The second row will display the voltage setting value and the current limit setting value.

Press down the **Shift** + **Display** keys simultaneously to entering the following menu:

00.0000V	00.0000A	OFF
00.0000V	0000.00W	35 °C

The first row will display the output voltage terminals measured value, current measured value and the operating mode of the programmable DC source. The second row will display the unit's DVM measured value, output power and internal temperature. Press the **Display** key to return to the main page.

4 Operation

4.1 Front Panel Description

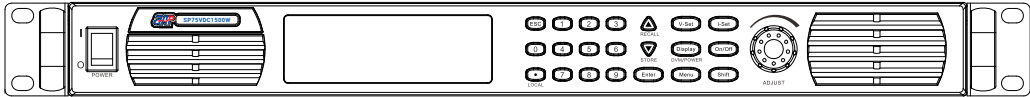

1U Height Models Front Panel

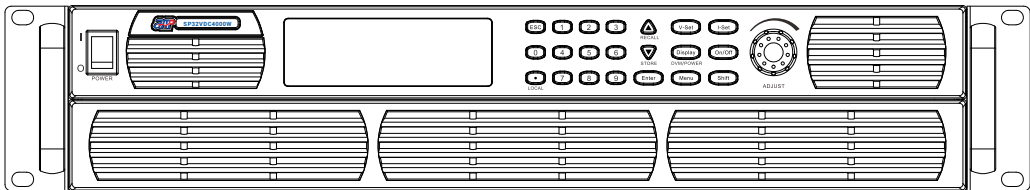

2U Height Models Front Panel

4.1.1 Description of Functional keys

Keys	Descriptions
	Number keys.
	Decimal point key.
	Escape key.
	Up key, for selecting menus or to increase the set value.
	Down key, for selecting menus or to decrease the set value.
	Confirm key.
	To set the value of the output regulation voltage.
	To set the value of output current limit.
	Press to return to main display.
	To turn the output of programmable DC source On or Off.
	To enter function setting iteams.
	Used in conjunction with multi-function key for more selections.

4.1.2 Description of Multifunctional Keys

Keys	Descriptions
LOCAL	To select front panel operation.
RECALL	To recall settings of programmable DC source from the memory storage.
STORE	To store the current settings of power supply.
DVM/POWER	To display DVM reading and output power.

4.1.3 Introduction to Front Panel Operations



- The Default setting values will be used if setting values are not saved before restart.

1. Front panel **On/Off** key is used for turning the power supply On and Off.
2. Operating modes include Front Panel operation mode, Remote operation mode and External operation mode, the first two can be switched by a connected computer and the operating mode can be changed without affecting the power supply output.
3. All front panel keys are functional when the power supply is in Front Panel operation mode.
4. Under remote operation mode, all Front Panel keys except the decimal point key are locked.

4.1.4 Front Panel Operations

4.1.4.1 Voltage Setting

Output voltage (CV MODE): Assure that the current setting is greater than the expected load current to maintain the output in CV mode, otherwise the output voltage will not be equal to the Output Voltage setting. There are two setting modes:





- The default location of the cursor after pressing the **V-set** key is at the first digit after the decimal point.
- The value will be entered from the highest to lowset, or it will be entered from the digit at the cursor if the user changes the default location of the cursor.

Option One (use key):

1. Press the **V-set** key, use the knob to change the cursor to the wanted digit, press the **0~9** numeric keys to set the voltage then press the **Enter** key to confirm.
2. Press the **On/Off** key to turn on the output.

Option Two (use knob):

1. Press on the key , use the knob to change the cursor to the wanted digit, and then turning the knob changes this digit value to increase or decrease the setting. Press the  key to finish the setting.
2. Press the  to turn on the output.

00.0000V	00.0000A	OFF
00.0000V	00.0000A	

4.1.4.2 Current Limit Setting

Current limit setting (CC MODE): assure that the voltage setting is greater than the desired load voltage to maintain the output in CC mode. If the output current limit setting is not equal that desired press the  key, and adjust the setting using a procedure similar to that of the voltage setting.











00.0000V	00.0000A	OFF
00.0000V	00.0000A	



Note

- The default location of the cursor after pressing the  key is at the first digit after the decimal point.
- The value will be entered from the highest to lowset, or it will be entered from the digit at the cursor if the user changes the default location of the cursor.

4.1.5 Store and Recall Operation

The user can store in non-volatile memory setting parameters that are commonly used, such as: voltage set value, the current set value, and keep them in 9 groups so that they can be recalled for later use. Store the parameters by pressing  +  +  ~  + . You can remove the parameters from the specified storage area by pressing  +  +  ~  + .

4.1.6 Menu Operation

The menu structure is designed to be navigated easily by using a few of the front panel keys. The menu options of a particular page can be highlighted by using the Δ ∇ keys. The Enter key is then used to select the highlighted menu option and the next sub menu page is then displayed. One can always return to the previous page by pressing the ESC key.

All the function setting items are shown in the table below.

Menu	Description
1. SYSTEM SETTING	To set system parameters.
2. OUTPUT SETING	To set the output parameters.
3. INFORMATION	To display the software version, power rating and other information.
4. PROTECTIONS	To set the protection settings.
5. SERIES/PARALLEL	To select Series or Parallel connection modes.
6. TIMER CONTROL	To set automatic operation timer.
7. SPECIAL TEST FUNC	To set special function test.
8. ADDITIONAL FUNC	Functions that are customizable by the user.

From the main display page press the Enter key to display the top page of the functions menu. Press the ∇ key to scroll down the menu.

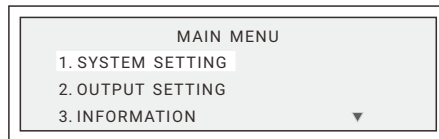

When you press the ∇ key third time the next part of the functions menu will be displayed.

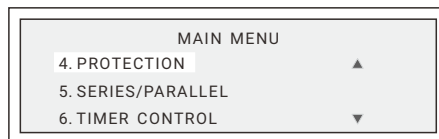

The third page can be displayed in a similar manner.

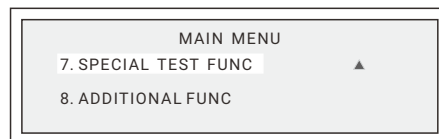

Press the **▽** key to select any of the highlighted menu items.

4.1.7 SYSTEM SETTING

Highlight the SYSTEM SETTING item and press **Enter** to select. The system setting sub-menu will be displayed.

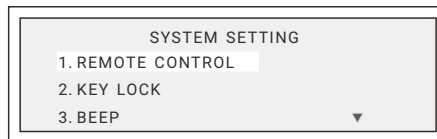

1. REMOTE CONTROL

This menu is for setting the parameters of the remote communication interfaces which include RS232, RS485, USB, LAN.

RS232

Press **Enter** key to enter the remote control menu:



After selecting the communications interface type using the **△** **▽** and then **Enter** keys, the user can change the communication parameters.

For example after selecting RS232 type the following sub menu will be displayed:

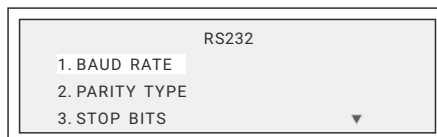

Highlight 1. BAUD RATE and press the **Enter** key to access the following sub-menu:

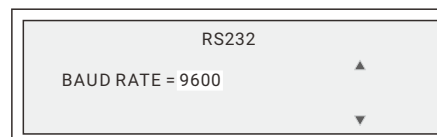

Then you can choose BAUD RATE, including 9600 (default), 19200, 38400, 57600, 115200; PARITY TYPE and STOP BITS can be set in a similar fashion as above. PARITY TYPE, including NONE (default), ODD, EVEN; and STOP BITS, including 1 (default), 2.

USB

Highlight USB and press the **Enter** key to access the following sub-menu:

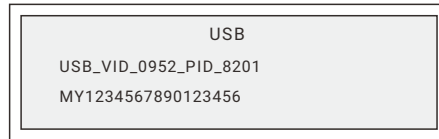

```
USB
USB_VID_0952_PID_8201
MY1234567890123456
```

LAN

Highlight IP ADDR and press the **Enter** key to access the following sub-menu:

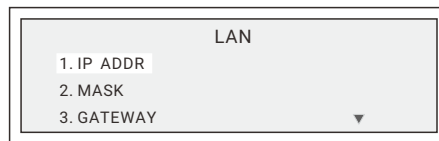

```
LAN
1. IP ADDR
2. MASK
3. GATEWAY ▼
```

Set the parameters by pressing the **0** ~ **9** + **Enter** keys.

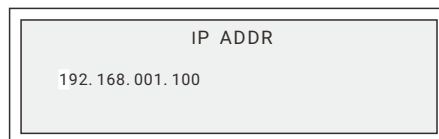

```
IP ADDR
192.168.001.100
```

MASK and GATEWAY setting can be set in a similar fashion as above, and press the number keys to choose the Address for the unit of between 000 and 255.

Press the **▽** key to select 4. LISTEN PORT. Set the LISTEN PORT of the power supply by pressing the **0** ~ **9** + **Enter** keys.

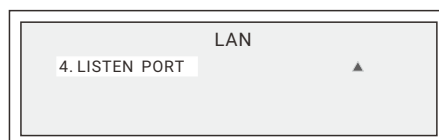

```
LAN
4. LISTEN PORT ▲
```

RS485



Highlight 4. RS485 and press the **Enter** key to enter the following sub-menu:

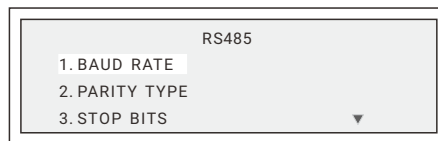

BAUD RATE, PARITY TYPE and STOP BITS setting can be set in a similar fashion as RS232's.

Press the **▽** key to select 4. RS485 ADDR.

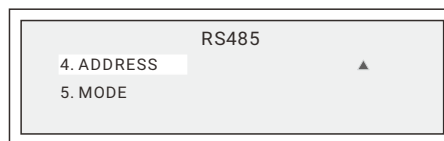

Press the numeric keys to set the Address for the unit from 001 and 254.

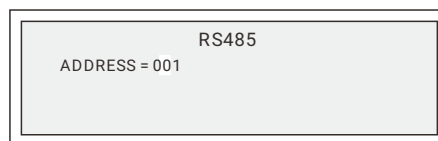

Rs485 supports MODBUS protocol, move the cursor to highlight MODE and press the **Enter** key to enter communication protocol selection menu, highlight the MODBUS option then press the **Enter** key to confirm.

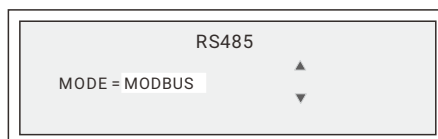

The power supply can use RS485 to provide multi-units series connection function for up to 30 units. Set each unit with a different address and add a 120 ohm resistor terminal in the last unit as shown in the below figure.

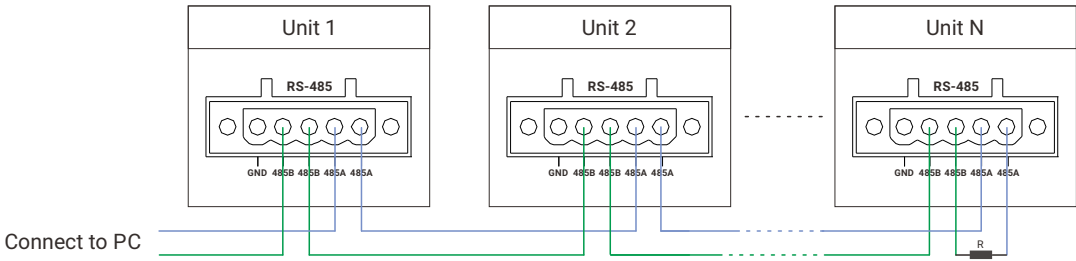

GPIB

Highlight GPIB and press the **Enter** key to access the following sub-menu:

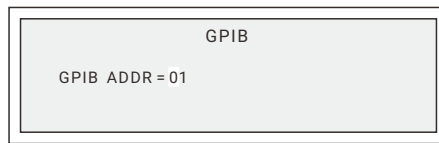

Press the number keys to choose the Address for the unit of between 01 and 30.

To return to the previous menu press the **Esc** key.

2. KEY LOCK

When set to ON, will deactivate all the front panel keys except the decimal point key. Press the decimal point key to unlock the keys.

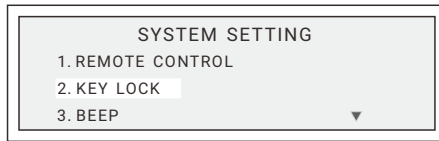

Press the **Enter** key to access the following sub menu:

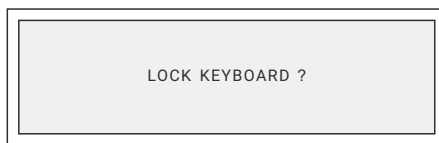

To lock the keyboard press the **Enter** key. The main page will be displayed and the 'Lock' symbol will be displayed at the bottom-right corner of the main menu. Press **Esc** key if you do not want to lock the front panel keys and then you can navigate up the menu structure as desired.

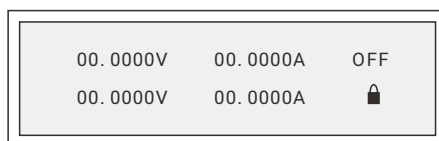

To unlock the front panel keys, press the decimal point key.

3. BEEP

With the BEEP setting, the user can select whether the buzzer sounds when a key is pressed.

Notes: 1. BEEP can be set to ON or OFF, default setting is ON.

2. When BEEP is set to ON, the buzzer will sound when pressing on any of the buttons or knobs.
3. When BEEP is set to OFF, pressing on any of the buttons or knobs will not cause the buzzer to sound.
4. When a system protection condition is detected, the buzzer will sound continuously to alert the user independent of the BEEP setting.

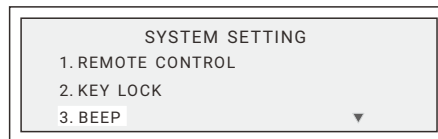

Highlight 3. BEEP item and press the **Enter** key to access the following menu:



Press the **▲** or **▼** key to move the highlight to ON or OFF, and then, press the **Enter** key, to turn on or turn off the buzzer sound.

Press **▼** key to enter the following page of the system setting menu:

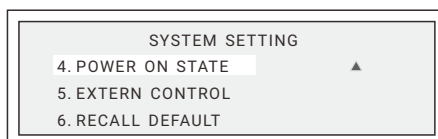

4. POWER ON STATE

This menu determines what state the power supply will enter into when it is turned on using the front panel switch or AC power is restored.

Highlight this menu item, and press the **Enter** key to enter the following sub-menu:

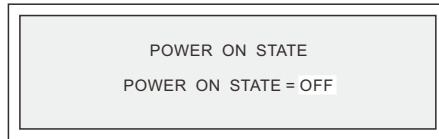

 Note

- POWER ON STATE has three options of setting: LAST, USER and OFF, which can be highlighted by pressing the ▲▼ keys.
- If it is set to LAST, the unit will record the output voltage and current settings and the power supply will remember these settings when it is turned back on.
- If it is set to USER, a user default setting list menu, which can be used to determine the power supply settings at AC turn on or AC power restoration, will be displayed as shown in the following figure.
- Upon turn on after being switched off, the power supply will turn back on with its' default settings; output voltage is set to zero, and current limit is set to maximum unless Last or User is programmed.

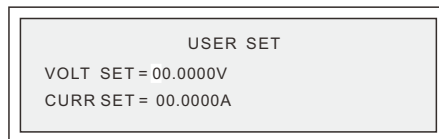

Attention: The output is always in the OFF state when the AC power is restored or switched on, independent of the selected setting mode.

5. EXTERN CONTROL

This item is for setting the external control inputs as either external voltages (max. 0-5V, actually 4.8V input will reach the max. output of the unit when selecting 5V) controlling the output voltage and /or current (“EXV” is displayed on the main page), or potentiometers (RES) controlling the output voltage and / or current (“EXR” is displayed on the main page).

Note: The EXTERN CONTROL mode will not function if master/slave mode is active.
High level for SW signal (above 2.5V) will enable the output of the unit.

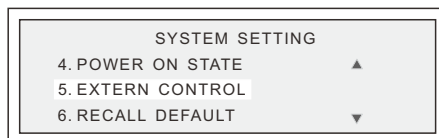

With the above menu item highlighted press the **Enter** key, and to enter the following sub-menu:



Then press the **Enter** key, and to enter the following sub-menu:

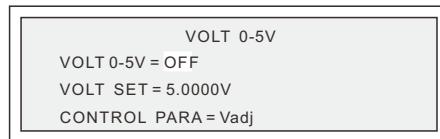

After selecting external voltage control item as ON, press the **Enter** key to move the cursor to the next line down. There you can set the control voltage range. For example for the SP75VDC1500W if the voltage range is set to 3V, (Vset=3.0000V), the DC power output control is as shown in Figure (a). CONTROL PARA includes Vadj (output voltage setting), Iadj (output current setting) and Both (voltage setting and current setting).

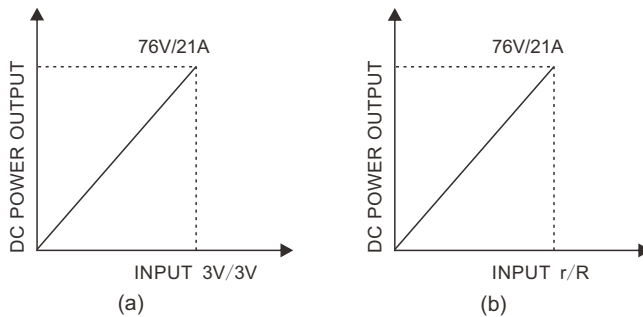

Similarly for the SP75VDC3000W, 0-3V can be used to program the current limit setting from zero to full scale.

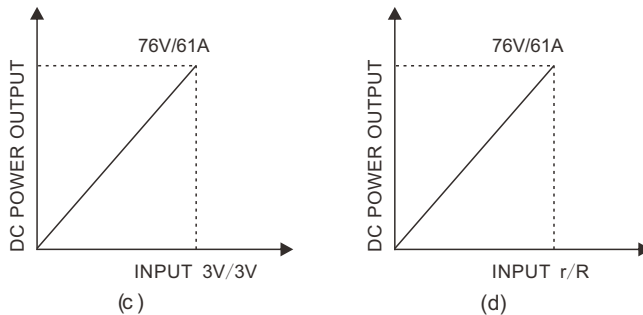

Selecting external potentiometer control is achieved in a similar manner to external voltage control, r is the divider resistance, R is the total resistance, the DC source setting simulation is shown in figure b/d.

6. RECALL DEFAULT

This menu is for restoring the system to the factory default settings.

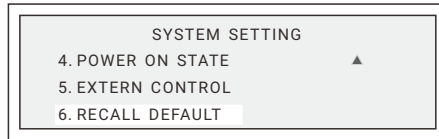

With the above menu item highlighted, press the  key to enter the following sub-menu:

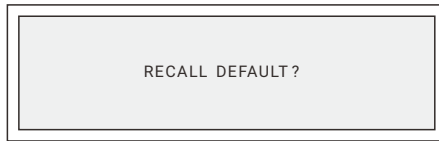

After pressing the  key again, all the parameter settings are restored to default value.

7. DISPLAY UPDATE

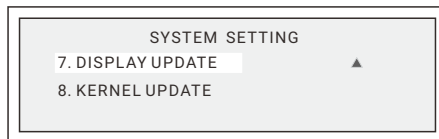

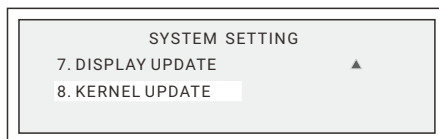

This menu is used for firmware upgrade in STM32, please contact customer service for more informations if needed.

8. KERNEL UPDATE



This menu is used for firmware upgrade in AVR, please contact customer service for more informations if needed.

4.1.8 OUTPUT SETTING

With the top function menu displayed highlight OUTPUT SETTING and press  key to enter the OUTPUT SETTING sub menu. Pressing the   keys, will successively show the following menu options.

1. VOLT LIMIT MAX; sets the MAX output voltage, the default is the Max voltage value;
2. VOLT LIMIT MIN; sets the MIN output voltage, the default setting is 0V;
3. CURR LIMIT MAX; sets the MAX output current, the default is the Max current value;
4. CURR LIMIT MIN; sets the MIN output current, the default is 0A;
5. ADVANCED FUNC, enables CURR SHARE/SHORT MODE and LV MODE function.

OUTPUT SETTING Menu details:

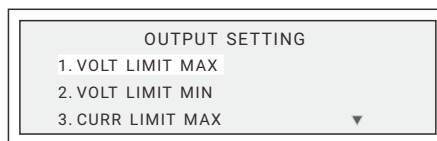

1. VOLT LIMIT MAX

When in the above menu, press the  key to enter the following sub-menu:

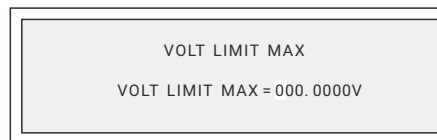

Use the front panel knob or number keys to modify the maximum output voltage limit.

2. **VOLT LIMIT MIN** setting can be set in a similar fashion as 1 above.
3. **CURR LIMIT MAX** setting can be set in a similar fashion as 1 above.
4. **CURR LIMIT MIN** setting can be set in a similar fashion as 1 above.
5. **ADVANCED FUNC**

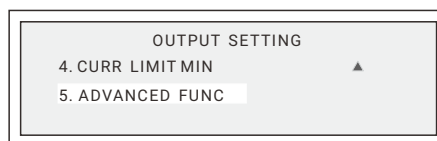

With the above menu item highlighted, press the  key to enter the following sub-menu, including 1. CURR SHARE, current sharing function, 2. SHORT MODE, enable the short protection when normal use, or disable the short protection when cable testing, and 3. LV MODE, low voltage mode.

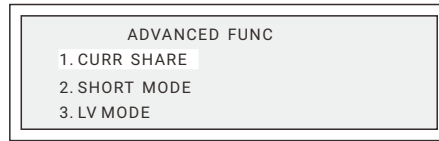

CURR SHARE

Enable current sharing setting when paralleling the units will keep the output balance between all the units in the system.

With the above menu item highlighted, press the **Enter** key to enter the following menu. Press the **△**/**▽** keys to turn the average current sharing function ON or OFF, the default setting is "OFF".



- With the CURR SHARE is on, the actual output voltage will be a little greater than the setting value.

SHORT MODE

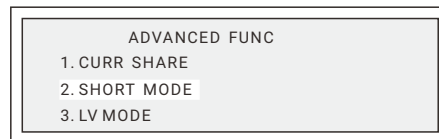

With the above menu item highlighted, press the **Enter** key to enter SHORT MODE setting sub-menu.

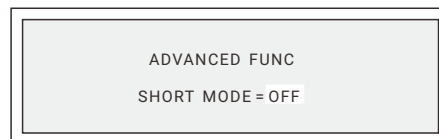

The default setting of SHORT MODE is on, which means when the power supply works in CC mode, output voltage is less than 0.7V, and output current is more than 2A, an output short circuit condition will be detected.

Using **△**/**▽** to turn it to off, then the power supply can be used in the application like cable test, or circuit breaker test. The setting will be kept until the user change it voluntarily after power off.



Warning!

- The unit will save the SHORT MODE setting after turned off, please turn off the SHORT MODE setting if not needed to prevent the possible damage to the device.

LV MODE

Enable this function will reduce the voltage ripple at low output voltage.

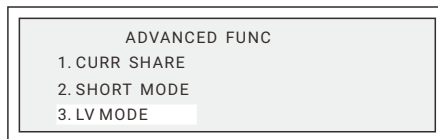

Press the keys to turn on the LV MODE.

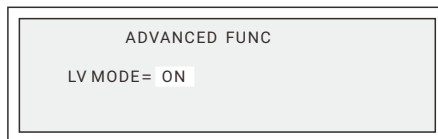

Warning!

- Enable this function may cause an OVER VOLTAGE alarm if output voltage is high.

Please turn off the LV MODE if the output is not in the expected range below.

NO.	Model	LV Mode Range
1	20V-1U	0~9V
2	32V-1U	0~13V
3	40V-1U	0~13V
4	75V-1U	0~20V
5	150V-1U	0~30V
6	200V-1U	0~40V

4.1.9 INFORMATION

The first page of the INFORMATION menu, displays the power supply model number, kernel version number, and control software version.

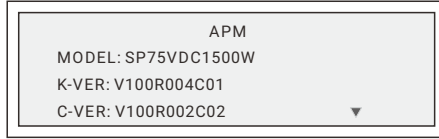

The second page displays display software version and serial number.

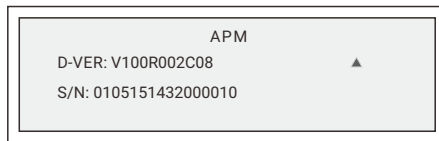

4.1.10 PROTECTION

Highlight PROTECTION and press the **Enter** key to select the PROTECTION menu, press the **△▽** keys to successively display the following sub-menu options.



1. OVP

With the above screen displayed, press the **Enter** key to select the Over Voltage Protection sub menu. And use the **△▽** keys to turn the OVP function ON. Press the **Enter** key to highlight the voltage value, and then set the over-voltage protection point using the knob or number keys. This feature protects the connected load by turning the output off should the output voltage exceeds the set point.

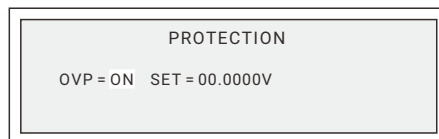

2. OCP

The Over-Current Protection setting can be adjusted in as manner similar to the OVP setting. If the output current exceeds the setting, the output will be turned off to protect the connected load.

3. OPP

The Over Power Protection setting can be adjusted in as manner similar to the OVP setting. If the output power exceeds this setting, the output will be turned off to protect the connected load.

4. CC TO CV

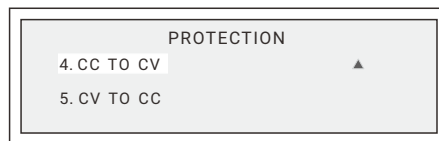

While in the above menu, press the **Enter** key to enter the following sub-menu, press the **△**/**▽** keys to turn on or off the CC TO CV protection. For description see section 4.1.10.4.

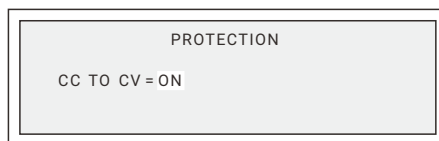

5. CV TO CC

Activate this protection mode in a manner similar to the CC TO CV.

4.1.10.1 Over Voltage Protection Function

If the DVM measured voltage is higher than the protection setting, the overvoltage protection function will be activated. The power supply will enter overvoltage protection mode (Over Voltage Protection), and the supply will automatically turn off the output voltage and current and the buzzer will sound. The OVP icon will be displayed. Press the **Enter** key to turn off the OVP protection and buzzer and remove the OVP icon.

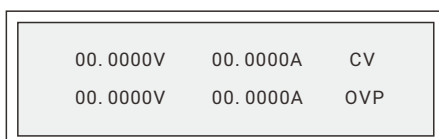

4.1.10.2 Over Current Protection Function

If the measured output current is higher than the protection setting, the overcurrent protection function will be activated. The power supply output will be automatically turned off and the buzzer will be sounded. The OCP icon will be displayed. Press the  key to turn off OCP and buzzer and remove the OCP icon.

00.0000V	00.0000A	CV
00.0000V	00.0000A	OCP

4.1.10.3 Over Power Protection Function

If the measured output power is higher than the protection setting, the Over Power Protection function will be activated. The power supply will automatically turn its' output OFF and the OPP icon will appear. Press the  key to turn the output back on, turn off the buzzer and remove the OPP icon.

00.0000V	00.0000A	CV
00.0000V	00.0000A	OPP

4.1.10.4 Constant Voltage Protection Function (CV TO CC)

When this function is activated, the power supply will stay in CV mode. If load changes force the system to transition from CV to CC (constant current) mode, the power supply will enter the "CV TO CC Protect" state that will shut off the output and display the CVC message on the display. Press  key to reset the protection and deactivate the buzzer.

4.1.10.5 Constant Current Protection Function (CC TO CV)

When this function is activated the power supply will stay in CC mode. If load changes forces the transition from CC to CV (constant voltage) mode, the power supply will enter the "CC TO CV Protect" state that will shut off output and display CCV message on the display. Press  key to reset the protection and deactivate buzzer.

00.0000V	00.0000A	CV
00.0000V	00.0000A	CCV

4.1.10.6 Over-temperature Protection Function (OTP)

If the temperature of the power supplies' heatsinks exceeds protection limits, the power supply will enter the Over Temperature Protection mode. The output will automatically be turned off, the buzzer will sound, and then the following screen will be displayed. Press the  key to turn the output back on, turn off the buzzer and remove the OTP protection screen.

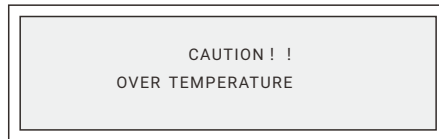

4.1.10.7 Short Circuit Protection

When the power supply works in CC mode, output voltage is less than 0.7V, an output short circuit condition is detected. The output will automatically be turned off, and the SCP screen below will be displayed. Press the  key to remove the protection screen and buzzer status.



Note

- This protection is only detected when the output current is more than 2A.

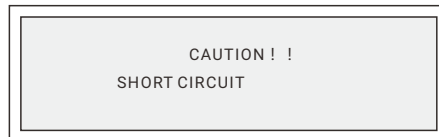

4.1.10.8 Over Voltage Protection

For each model, when its output voltage is higher than the setting point of hardware OVP shutdown point, the power supply will enter the "Over Voltage Protection" mode that will shut off the output and display the alarm message as shown in the following figure. Press the  key to remove the protection and buzzer status.

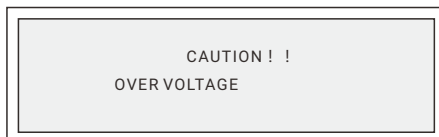

4.1.11 SERIES/PARALLEL

The power supplies use the Mater/Slave mode to increase the output power capability of a system while operating a single power source.

SERIES / PARALLEL
 MASTER/SLAVE = MASTER
 SELECT MODE = PAR

 **Warning!**

- Don't connect units in both series and parallel at the same time.
- Don't connect different models in parallel or in series.
- Assure that current share wires are not present when the outputs are connected in series.
- Make sure the wires and any fuses or breakers are of sufficient rated current and voltage and ensure the output is grounded at a single point when the power supplies are connected in series or parallel.

4.1.11.1 Series and Parallel Connection Setting

Figure (a) illustrates how to connect the communication cables between the units when they are connected in series. Figure (b) illustrates how to connect the communication cables between the units in when they are connected in parallel.

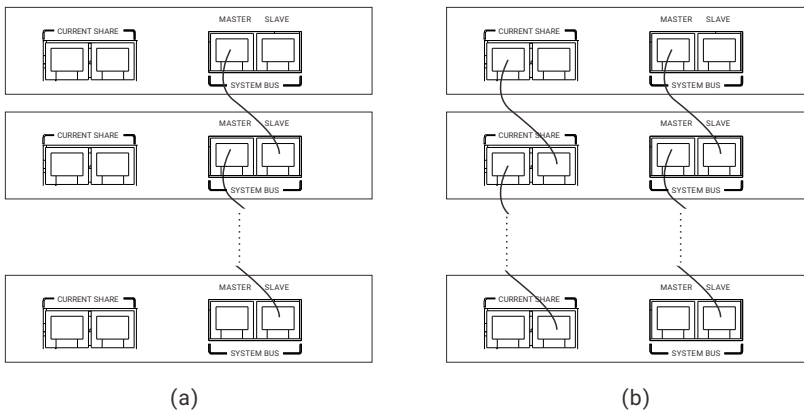

4.1.11.2 Series/Parallel Mode Setting

4.1.11.2.1 Setting of SLAVE

 **Caution!**

- Set the SLAVES first, and then the MASTER.
- Refer to Appendix A to get the most amount of slaves for different models, here we take 3 Slaves as an example.

After wiring is complete, configure one unit as the Master and the other three as Slave 1, 2 and 3. From the function menu highlight SERIES / PARALLEL and press the **Enter** key to enter the SERIES/PARALLEL sub menu. Press the **▲▼** keys to select SLAVE 1 for the system and press the **Enter** key to confirm the setting. Use the same procedure to set SLAVE 2 and 3 for another two (2) supplies as shown below.

00. 0000V	00. 0000A	OFF
00. 0000V	00. 0000A	SL1

4.1.11.2.2 Setting of MASTER

From the function menu highlight SERIES/PARALLEL and press **Enter** key to enter the SERIES /PARALLEL sub menu. Press the **▲▼** key to select MASTER for the supply and press the **Enter** key to confirm. The highlight will continue to the next line for the PAR/SER mode selection. Press the **▲▼** keys to select PAR for the particular supply and press the **Enter** key to confirm the setting. After the unit is configured to be the Master, it will start searching for all slaves that are connected to the Master.

SERIES / PARALLEL
MASTER/SLAVE = MASTER
SELECT MODE = PAR
CHECKING FOR SLAVE...

The master unit display will appear as below once the slaves are found as long as communications between the units is normal:

SERIES / PARALLEL
MASTER/SLAVE = MASTER
SELECT MODE = PAR
FOUND SLAVE 3

At the current interface, press the **Enter** key to the following interface. Press the **▲▼** keys and **Enter** key to select and confirm to release from the Master-slave mode or keep that.

AFTER POWER OFF
1. RELEASE FROM THIS M/S MODE
2. KEEP THIS M/S MODE

The MASTER unit will display the following when operating:

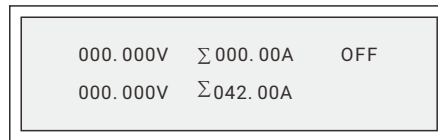

To release from this operation mode (parallel operation mode in this example), turn off of the output of Master unit, press the decimal point key to return to the local operation for the slaves. Or to access to the SELECT MODE item by using the front panel keys of the Master, select OFF option and press the  key to confirm.

The MASTER can have two functions as described below:

1. Once the Master and Slave settings are done, users can then operate the Master only to set up the combined output voltage and current of the complete system.
2. The MASTER unit accepts all the measured values from SLAVES, and calculates all the statistics to show on its' main screen. In addition, if one of the SLAVE units triggers any of their set protection features, the protection information will be shown on the masters' main screen. Then the MASTER and all the SLAVES will turn off, and the MASTER/SLAVE control will be deactivated.



Caution!

- If multiple DC power supplies are connected in series or parallel, only one DC power supply can be set as MASTER and the rest are to be set as SLAVES.
- If different SLAVES are set to be the same number (such as SLAVE 1 & SLAVE 1), a communication error will occur. If this happens turn off the series / parallel control mode. Then set the SLAVE numbers to be unique, and resume series / parallel operation.
- After power-off, if you want to keep the previous Master-slave mode setting successfully, please turn on the Slave first, then turn on the Master.

4.1.11.2.3 List of Series and Parallel Errors

If abnormal communications occur, the MASTER searches for SLAVES and will trigger the following screen to be displayed:

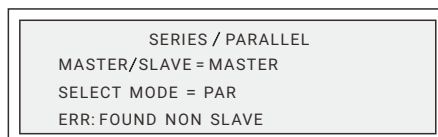

If the “MASTER” reports an alarm during operation the units outputs will turn off, the buzzer will sound and the following screen will be displayed on its front panel:

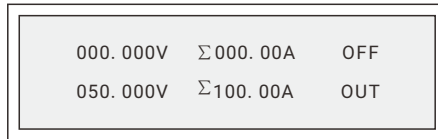

This could be caused by the following problems:

1. There are more than one “SLAVE” with same name;
2. There is more than one power supply set as “MASTER”;
3. A communication failure has occurred between the “MASTER” and the “SLAVES” during operation;
4. The “SLAVE” outputs are not synchronized;
5. A “SLAVE” unit shutdown is not synchronized;

4.1.12 TIMER CONTROL

From the main control screen please press **Menu** button, to select the TIMER CONTROL sub-menu.

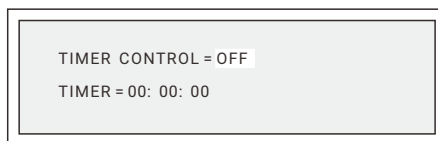

Press **▲** or **▼** to turn on or off timer control function. After selecting timer control item as ON, Press the **Enter** key to move the cursor to the next line down. There you can set the length of the time by the knob or number keys. The maximum time that can be set is 99 hours 59 minutes and 59 seconds. After setting up the time, please press the **Display** key to return to the main page. After setting up the voltage and current and press the **On/Off** key to turn on the output, the screen will show the countdown of the timer. Once it reaches down to zero, the supply will turn off the output automatically.



- TIMER CONTROL mode will not work when the units are in master/slave mode.

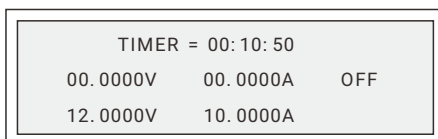



Caution!

- The timing function is not repetitive. Once the time counts down to 0, the output is turned off and TIMER CONTROL is set to OFF.

4.1.13 SPECIAL TEST FUNCTIONS

1. PROGRAM MODE

The user can program executable LIST files that will define a wave shape of the output voltage and current that can be repetitive or non-repetitive as desired. Follow the instruction below to define the files, load and execute them.

From the top menu highlight SPECIAL TEST FUNC and press **Enter** to enter the sub-menu as below.

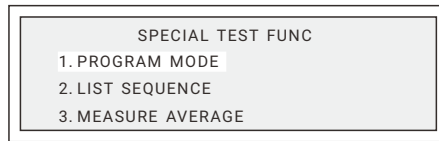

Then select PROGRAM MODE to display the following options:

1. EDIT FILE FORMAT
2. EDIT LIST FILE
3. LOAD LIST FILE

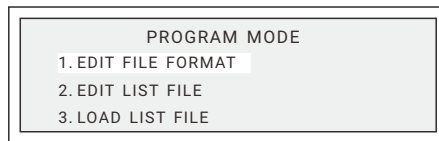



- (1) Select EDIT FILE FORMAT.
- (2) The screen displays the default “List” Modes as shown below.



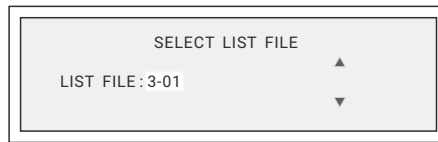

2*150 Steps	Set List1 of 2 variables and 150 steps
3*25 Steps	Set List2 of 3 variables and 25 steps
5*30 Steps	Set List3 of 5 variables and 30 steps

- (3) Select the desired list modes and press the **Enter** to confirm.
- (4) Press the **▽ + Enter** key to choose EDIT LIST FILE to confirm.
- (5) The display will show a file name as below, press **△▽ + Enter** keys to choose a file name.

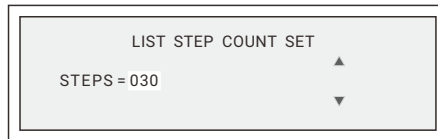



- (6) Press the , the display will show LIST STEP COUNT SET, press the  +  to confirm "LIST FILE 1" and Steps.

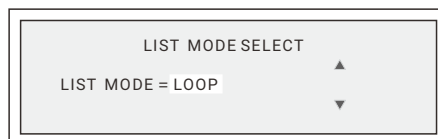

- (7) The display will show "LIST MODE SELECT", press  button and select the operation mode amongst
- LOOP which means LIST FILE loop execution.
 - CONT which means LIST FILE execution countdown, the execution will stop upon completion until the next touch of the  key.
 - STEP which means LIST FILE execution will stop at each step until the next touch of the  key.



- (8) The display will show the content as below, press the  ~  +  to set the output voltage start value (Vstar), output voltage end value (Vend), and rate of voltage change (Vrate).

Note: The Vrate can be set from 0.00001V/s to 4000V/s.

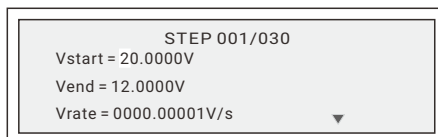





- Refer to the table below for slew rate setting for different models.

NO.	Models	Slew rate setting range	NO.	Models	Slew rate setting range
1	20V-1U	1600	9	75V-2U	11000
2	32V-1U	13000	10	80V-2U	11000
3	40V-1U	8000	11	120V-2U	21000
4	75V-1U	21000	12	150V-2U	30000
5	150V-1U	16000	13	200V-2U	20000
6	200V-1U	22000	14	600V-2U	21000
7	32V-2U	3000	15	800V-2U	21000
8	40V-2U	5000			

(9) Press the  button, to enter the next page, set the current limiting value (Iset) and time duration (Tcon), using a setting method similar to that in (8) above.

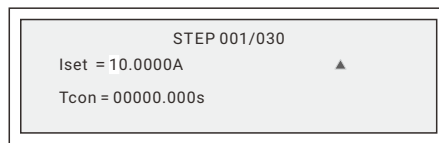
Note: The Tcon can be set from 0s to 99999.999s.



(10) After completion of STEP1 settings, press the  button to enter STEP 2. Select the settings for STEP2 in a manner similar to STEP 1.

(11) Continue to set up subsequent steps until you have programmed all the desired steps.

(12) If desired to add additional program files repeat steps of 5~10 to edit other LIST FILES.

(13) To load the file choose LOAD LIST FILE and confirm.

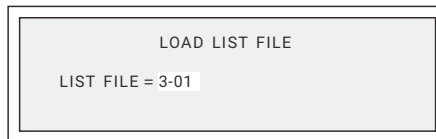

(14) The power supply will display the RUN LIST menu as shown below.

```

000.000V    00.0000A
MODE: LOOP  0000001
[ESC] To Exit
[Enter] To Start

```

Press the **Enter** key to start execution of the programmed wave shape.

2. LIST SEQUENCE

```

SPECIAL TEST FUNC
1. PROGRAM MODE
2. LIST SEQUENCE
3. MEASURE AVERAGE

```

Highlight 1. EDIT LIST SEQUENCE item and press the **Enter** key to display the sub-menu below.

```

LIST SEQUENCE
1. EDIT LIST SEQUENCE
2. LOAD LIST SEQUENCE

```

The display will show a file name as below, press **Δ▽ + Enter** keys to choose a file name.

```

SELECT LIST SEQUENCE
LIST SEQUENCE: 1

```

Press the **Enter** key, the display will show SEQUENCE STEP COUNT, press the **Δ▽ + Enter** keys to confirm "LIST SEQUENCE 1" and Steps.

```

SEQUENCE STEP COUNT
SEQUENCE STEPS = 5

```

The display will show "SELECT SEQUENCE MODE", press **Δ▽** button and select the operation mode amongst

a) CYCLE which means the waveform will output automatically during the cycle.

b) STEP which means SEQUENCE execution will stop at each step until the next touch of the

Enter key.

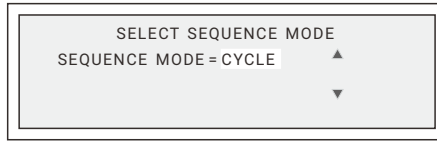

The display will show the content as below, after pressing the **[Enter]** key. Press the **[0]~[9]+[Enter]** to set the cycle times, which from 0 to 9999999, and 0 means endless loop.

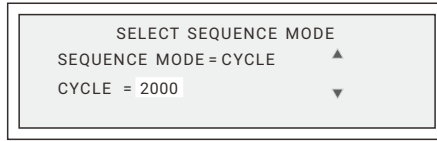

Press the **[▽]** key to select the list files. Each step is a complete file saved in PROGRAM MODE menu. Press the **[0]~[9]+[Enter]** keys to set the run times of the current step.

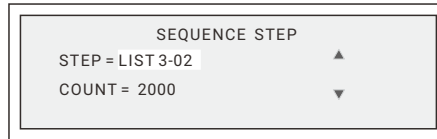

Highlight 2. LOAD LIST SEQUENCE item and press the **[Enter]** key to select the sequence file.

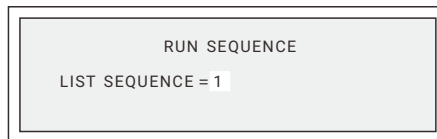

The display will show the content like below, press **[Enter]** key to run the sequence.

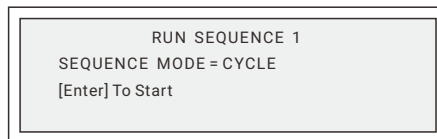

3. MEASURE AVERAGE

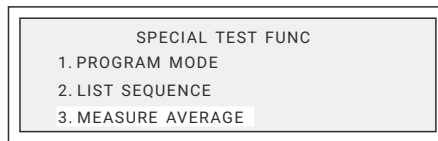

Highlight MEASURE AVERAGE and press the **Enter** key to display the setting sub-menu below.

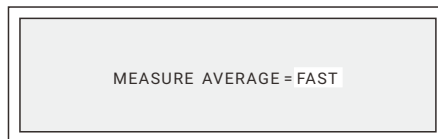

The averaging times of the output voltage, current and power measurements can be adjusted to be FAST, MEDIUM or SLOW by using the **▲▼** keys to display the desired speed and then pressing **Enter** key to select.

4.1.14 ADDITIONAL FUNC

Highlight 8.ADDITIONAL FUNC and press the **Enter** key to enter ADDITIONAL FUNC submenu.

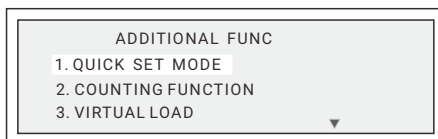

1. QUICK SET

Highlight 1.QUICK SET MODE and press the **Enter** key to enter quick set mode, the display will show the voltage and current setting parameters which are stored in the units' memory, the default recall is from group 1.

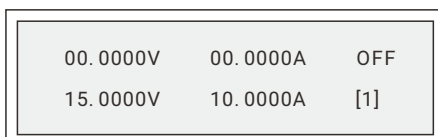

The user can change the parameters by pressing [1] ~ [9], the display will show the new settings, and the number at the right-bottom of the front panel will also be changed. Press the [Esc] key to exit quick set mode.

 **Note**

- Parameters should be preset and stored in memory.
- All the front keys are locked except [Esc] key and [On/Off] key when the power supply is in the quick set mode.

2. COUNTING FUNCTION

This function offers testing of the cut-off time of a breaker or a fuse.

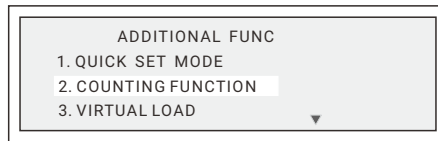

Press the [Enter] key to enter counting mode selection sub-menu.

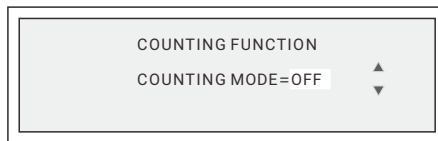

The options include VOLTAGE, CURRENT and OFF.

In VOLTAGE counting mode, the user need to set the voltage (Vset), current (Iset) and IL (cut-off current for counting).

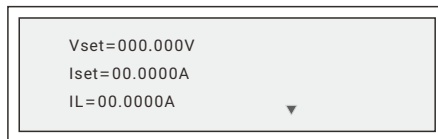

Press the [Enter] key turn to the page below after finishing the settings.

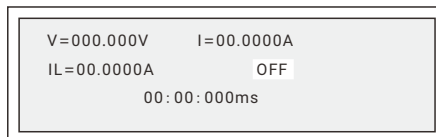

Press the **On/Off** key to turn on the output, the system will start counting the timer until the breaker or fuse is open, when output current is less than IL.

In CURRENT counting mode, the user need to set the voltage (Vset), current (Iset), Ib (breaker /fuse current) and IL (cut-off current for counting).

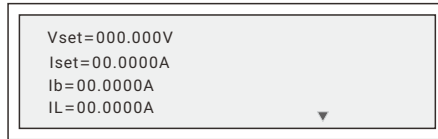

Press the **Enter** key turn to the page below after finishing the settings.

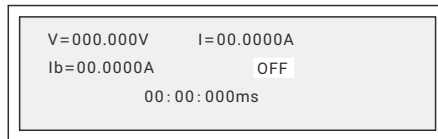

Press the **On/Off** key to turn on the output, the counts from when output has reached the Ib current until the breaker or fuse is open, when output current is less than IL.

 **Note**

- If the user pauses the output of the unit, it will save the current time and continue to timing when the output current has reached Ib current again.

3. VIRTUAL LOAD

The power supply has an internal dummy load that can be enabled to increase the speed of the voltage fall time.

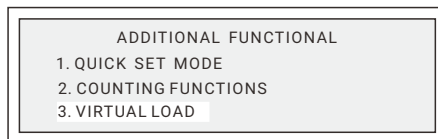

Highlight 3. VIRTUAL LOAD option and press the **Enter** key to enter the setting sub-menu, select AUTO option to enable the dummy load.

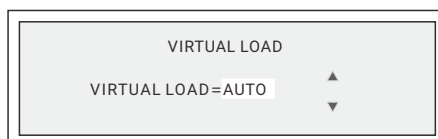

- ① Current sharing connectors, used for connecting between parallel units to enable current sharing.
- ② Remote sense wire connector, used for connecting wires to the remote sensing point for regulating the voltage at the load and compensating for wiring voltage drops.
- ③ DC output terminals.
- ④ RS-232 communications connector.
- ⑤ DVM connector.
- ⑥ RS485 communications connector.
- ⑦ ANALOG INTERFACE terminal which has GND, SW (for remote turn on input, when the input is more than 2.5 VDC, the unit will turn on, when the input is less than 1.2V, the unit will turn off), ladj (for external analog voltage or potentiometer input to remotely control the output current regulating point of the power supply), Vadj (for external analog voltage or potentiometer input to remotely control the output voltage regulating point of the power supply) and 5V.
- ⑧ LAN communications connector.
- ⑨ SYSTEM BUS control; used for communication between the units for master and slave control.
- ⑩ USB communications connector.
- ⑪ GPIB communications connector.
- ⑫ AC Power input connector; pay attention that the ground terminal wire is connected to earth ground.
- ⑬ The fan duct outlets; do not block the fan duct outlets otherwise the units' cooling may be compromised.
- ⑭ Termination resistor for RS485 and CAN communication.

 Note

- There is a slight difference between these two kinds of rear panels of 2U units.

4.2.1 Input Connection

 Warning!

- Be sure to connect the green/yellow wire to connect ⚡ terminal of the AC Power input terminal block to earth ground, otherwise an electric shock hazard may exist!
- There is certain danger on connection of AC power supply, please assure that the AC power cable is installed by a qualified electrician or technologist. Also if the unit AC input is to be hardwired please assure that this is done by a qualified electrician.

- This supplied, safety approved, AC power supply cable is #10 AWG size (SJTW or STW or equivalent. min. 80°C) that can handle the highest rated input current. If the AC power cable is in need of replacement please assure the type and rating is approved by qualified engineer or electrician before installation to prevent possible fire or shock hazard.
- Be sure to disconnection from AC before access to DC output and AC input compartment.



Note

- An external circuit breaker which disconnects all current carrying conductors for the AC input, detailed specifications as follow.
 - a) Circuit breaker must be suitably located and easily reached.
 - b) Circuit breaker must be marked as the disconnecting device for the equipment.
 - c) Circuit breaker must be CSA or UL certified in Canada and USA respectively and to the relevant local standard in other countries.

Power	600W		800W
Breaker	110/120VAC, 20A or 220/230/240VAC, 15A		110/120VAC, 25A or 220/230/240VAC, 15A
Power	1000W/1200W		1500W/1600W
Breaker	110/120VAC, 20A or 220/230/240VAC, 15A		110/120VAC, 25A or 220/230/240VAC, 15A
Power	2000W	3000W	4000W
Breaker	220/230/240VAC, 20A	220/230/240VAC, 25A	220/230/240VAC, 30A

Input Connections for 1U units:

1. Strip the outside insulation of the AC cable approximately 35 mm. Strip 10 mm of insulation from the end of each of the wires.
2. Use a Phillips number 2 screwdriver to loosen the 3 screws on the AC terminal cover plate, and remove the plate being sure to not lose the screws.
3. Loosen the plastic nut of the supplied cable strain relief clamp.
4. Pass the cable end including the line wire, neutral wire, and ground wire through the cable clamp and nut according to the direction of the drawing below, and then insert it into the line, neutral, and ground terminals respectively.
5. Using a suitably sized flat blade screwdriver tighten the screws on the top of terminal block assuring the wires are held tightly.
6. Replace and fasten the terminal cover plate, and tighten the plastic nut of the cable strain relief clamp.

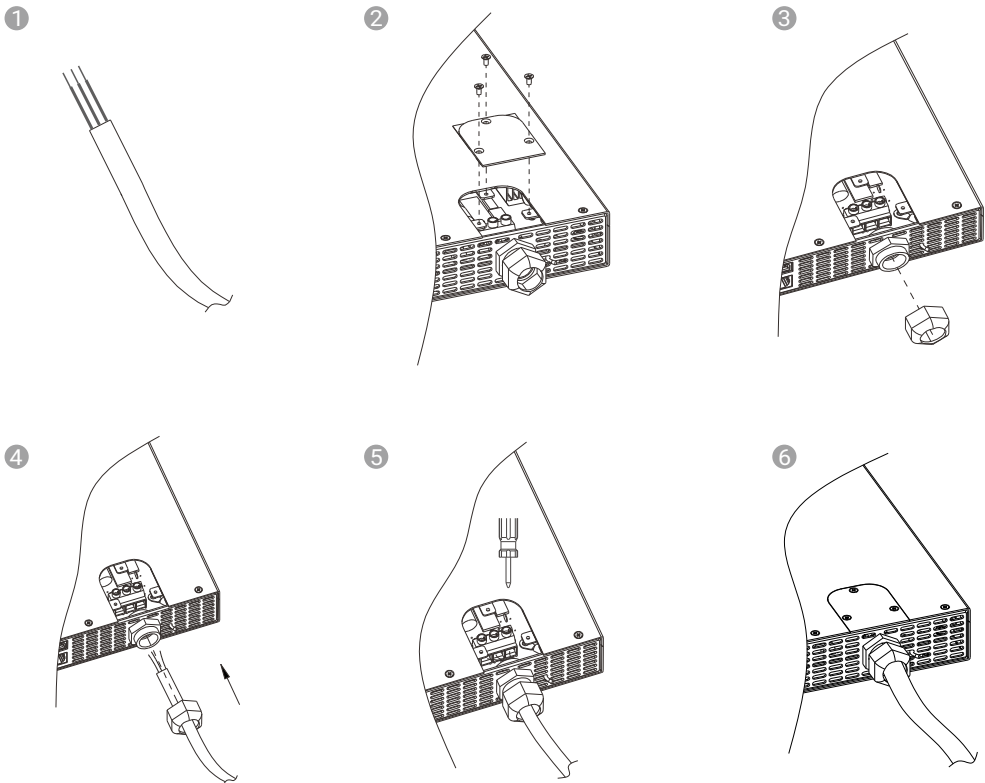

Input Connections for 2U units:

1. Strip the outside insulation of the AC cable approximately 25mm. Strip 7mm of insulation from the end of each of the wires.
2. Loosen the plastic nut of the supplied cable strain relief clamp.
3. Pass the cable end including the line wire, neutral wire, and ground wire through the cable clamp and nut according to the direction of the drawing below, and then insert it into the line, neutral, and ground terminals respectively.
4. Using a suitably sized flat blade screwdriver tighten the screws on the top of terminal block assuring the wires are held tightly.
5. Replace and fasten the terminal cover box, and tighten the plastic nut of the cable strain relief clamp.

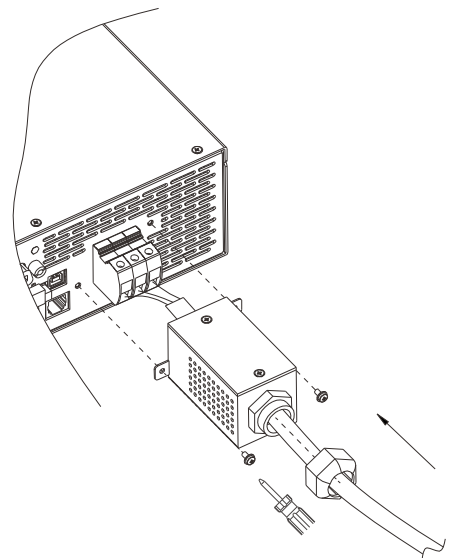

4.2.2 Load Connections



Warning!

- When connecting the load, turn off the power supply by turning off the AC power switch or disconnecting the AC power cable.
- Assure that all the screws are properly tightened.



Attention!

Consider the following issues when connecting the load.

- Assure that the wire used is rated to handle the maximum output current of the power supply in the maximum expected ambient temperature.
- Assure that the withstanding voltage rating of the insulation of the wires is greater than maximum output voltage of DC power supply or series connection voltage of the power supplies.
- The maximum wire length and voltage drop.
- Load noise and impedance effect.

Please refer to the table below to select cable size. Also consider temperature rating of the copper wires and voltage drop to the load:

Rated Current of equipment (A)	Minimum Conduct Sizes		Rated Current of equipment (A)	Minimum Conduct Sizes	
	Nominal Cross-sectional Area (mm ²)	AWG or kcmil		Nominal Cross-sectional Area (mm ²)	AWG or kcmil
13~16	1.5	14	125~160	50	0
16~25	2.5	12	160~190	70	000
25~32	4	10	190~230	95	0000
32~40	6	8	230~260	120	250 kcmil
40~63	10	6	260~300	150	300 kcmil
63~80	16	4	300~340	185	400 kcmil
80~100	25	2	340~400	240	500 kcmil
100~125	35	1	400~460	300	600 kcmil

Load connections for 1U units:

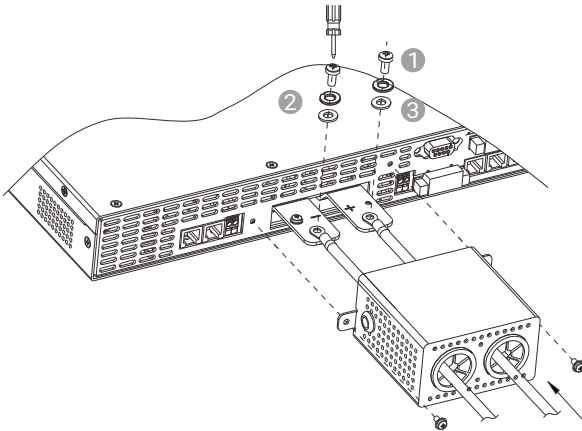

- ① M6*12 screws
- ② Spring washer
- ③ Washer

3. Install the safety outer cover to avoid contact with live terminals.

1. Strip 10 mm off the end of each of the wires, and install ring type crimp terminal using proper tooling.
2. Use a Phillips Number 3 screwdriver to secure the DC output positive and negative terminals to the termination bars. Assure that the screws are tight and that the connection is of correct polarity.

Load connections for 2U units.

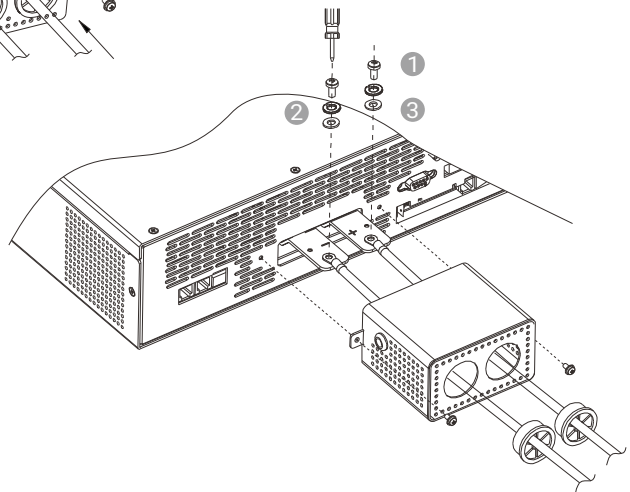

4.2.3 Remote Compensation

4.2.3.1 Connecting Method

1. Remote sensing allows the power supply to automatically compensate for the voltage drop in the load leads. The 1U and 2U units can be compensated at most 5V but using wires large enough to assure less than 1 volt total voltage drop is highly recommended.
2. The correct connection is shown on the chart. Use AWG 22 wire (best to use twisted pair wires or cable) and connect the 2 wires to the positive and negative load terminals and route the other ends to the Sensor+ and Sensor- inputs at the rear panel. Be sure to strip 5~7 mm of insulation off the wires before installing them into the sense line terminal block and assure that the wires are connected in the correct polarity.

4.2.3.2 Sensor Wire Not Connected or Reverse Polarity

The polarity of sensor wire must be connected in the correct polarity, that is “+” sense wire terminal connects with the “+” output terminal or “+” load terminal, while the “-” sense wire terminal connects with the “-” output terminal or load terminal. If the sense wire polarity is reversed, the power supply will be tuned off.

The Power supply will operate properly even if the sense wires are not connected but the load regulation will not quite as accurate as the sensing point will be inside the power supply.

Note: Please follow the steps given below should the sense wire be connected in reverse:

1. First turn-off the unit;
2. Disconnect one end of the sense wires and connect to the correct polarity.
3. Turn the unit back on.

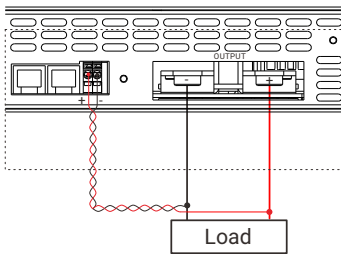

Sensor Wire Connections for 1U units

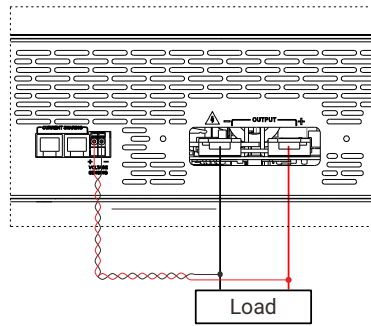

Sensor Wire Connections for 2U units

Note: Do not connect sensor wires to the load when units are connected in series.

4.2.4 DVM Function

DVM is digital voltage meter, make sure that DVM+/- inputs are connected to the right polarity of the measured load points. The connection wire should be 22 AWG, strip off 5~7 mm of insulation off the wire end.

5 Application

5.1 External Setting

The external setting is adjusted using the EXTERN CONTROL menu. The programmable DC supply can be controlled by external voltages (0~5V) or external potentiometers (5K~10K) in order to remotely adjust the power supply voltage and current regulation settings. See figures below for connecting the external control inputs.

Connection of Voltage or Potentiometer inputs.

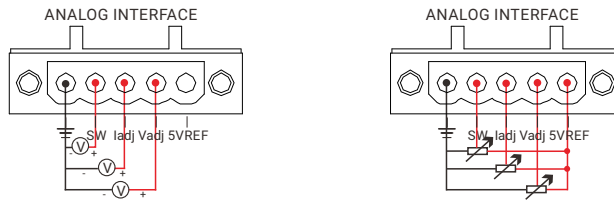

The external potentiometers or voltage sources will proportionately adjust the voltage and current regulation points of the power supply according to the programmed or default internal setting of these inputs.

00.0000V	00.0000A	OFF
12.0000V	10.0000A	EXV

5.2 Timer Control Function

The timer function is programmed using the TIMER CONTROL menu as described in section 4.1.12. Activate the timer by highlighting OFF and use the Δ / ∇ keys to select ON. Press the **Enter** key on the front panel to start the timer which will turn on the power supplies output and count down toward zero. The power supplies' output will be turned off when the timer reaches zero.

TIMER = 00:10:50		
00.0000V	00.0000A	OFF
12.0000V	10.0000A	

5.3 SHORT MODE Function

The SHORT MODE function is useful for testing a breaker or cable. See below for the connection in testing mode.

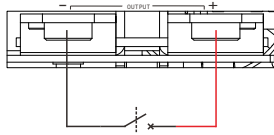

circuit breaker test

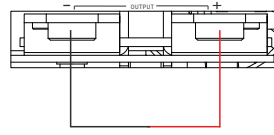

cable test

From the main display page press the **Menu** key to display the below function menu. Highlight the 2. OUTPUT SETTING item and press the **Enter** key to select.

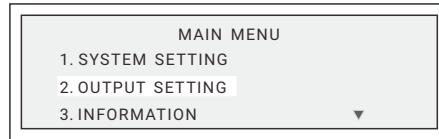

Highlight the 5. ADVANCED FUNC item and press the **Enter** key to select.

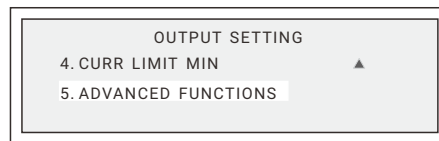

Highlight the 2. SHORT MODE item and press the **Enter** key to select.

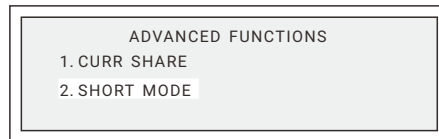

Use **△▽+Enter** key to turn it OFF, then the power supply can be used in the application like cable test, or circuit breaker test.

The setting will be saved after power off, until the user change it voluntarily.

SHORT MODE = OFF

5.4 Master-slave Mode Configuration

The schematic of cable connections below is for reference only. The user should install the cable connections based on actual application requirements.

Note: Take SP75VDC3000W as an example.

Parallel Connection

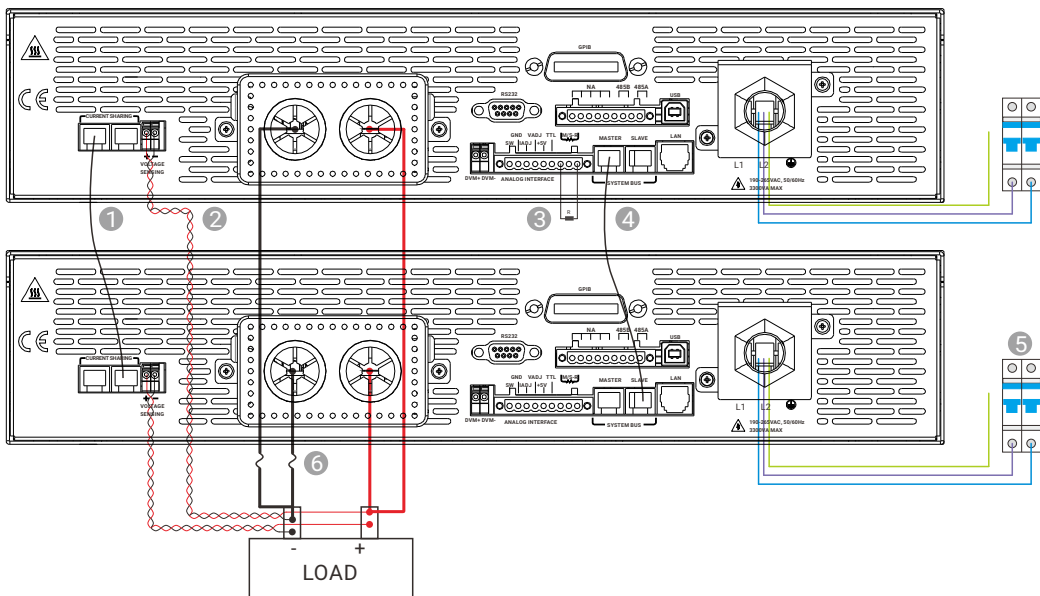

- ① Do not install the Master / Slave current sharing cable if the power supplies are connected in series, otherwise serious damage to the units may occur.
- ② The polarity of voltage sense wires must be correct.
- ③ 120Ω resistor terminator must be connected in the first unit or the last unit in Master/Slave mode, some models using DIP switch CAN-R.
- ④ SYSTEM BUS cable; connect for communication between master and slave units.
- ⑤ AC breaker, see 4.2.1 for details.
- ⑥ To ensure safety, include a fuse in series with each negative cable, the rated voltage and rated current of the fuse should be 1.5 times that of the power supply.

Series Connection

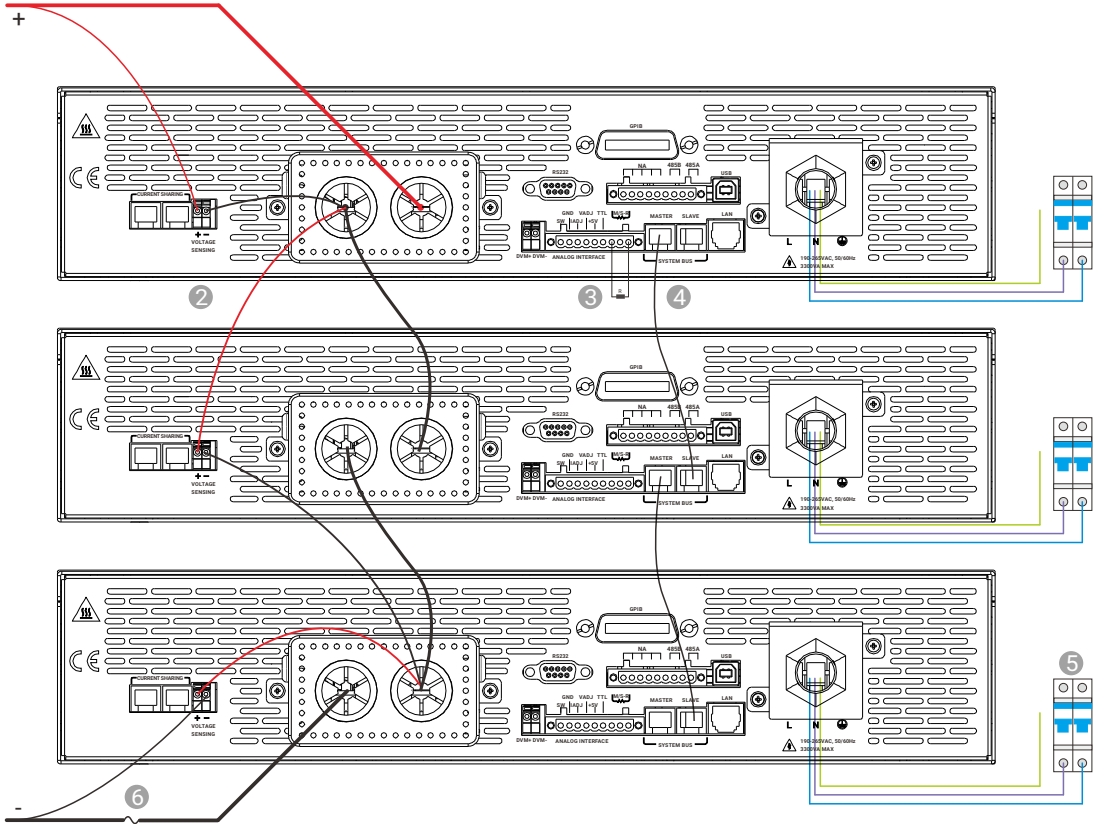

Assure that the power supplies inputs are initially turned off and connect the DC power cables. After confirmation of correct connection polarity turn on the input switch and, set the power supplies to the same voltage and current regulation points. Turn on the power supply outputs and confirm that the measured output voltages are within the rated tolerance range.

Set up the configuration of the master and slave units as described in section 4.1.11. Select the appropriate connection mode, series or parallel.

5.5 List Function

The list function can be used to program and execute a test program consisting of up to 30 steps. Each step consists of a start voltage (V_{start}), an end voltage (V_{end}), a rate of change of voltage (V_{rate}), a current limit setting (I_{start}) and a dwell time of the end voltage (T_{con}). The test program can be of 3 different trigger modes (Step/Continue/Loop). The test program waveform will look something like that shown below.

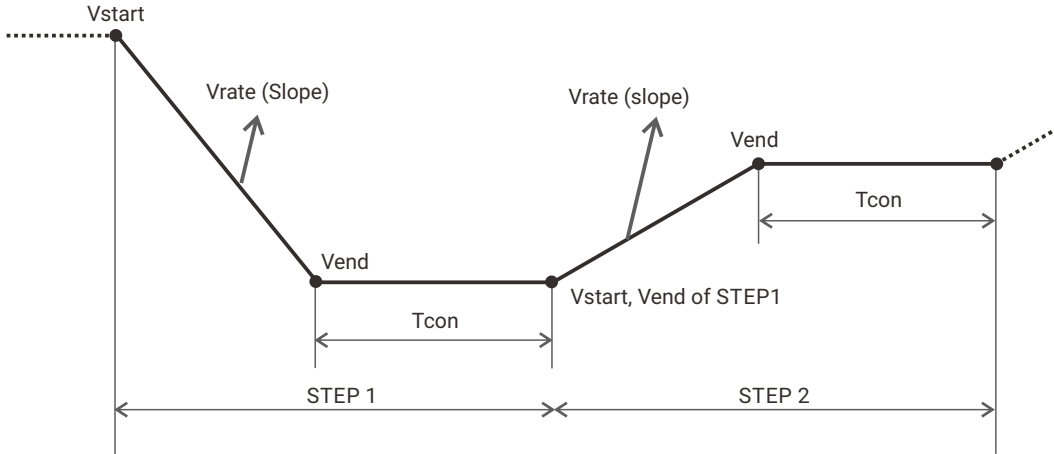

Program the test program using the procedure described in section 4.1.13 (1).



Load the List program file and run when desired.

Some models provides automotive power test waveforms compliant to DIN 40839 and ISO 16750-2 standards that can simulate common test conditions for electronic devices installed in automobiles.

6 Introductions to Software

The DC Power Control Panel is monitoring software developed by APM Technologies especially for use with this series Programmable DC Power Supplies. The software features easy installation into a PC and convenient operation. Depending on the type of external power connection, the user can choose between SINGLE MODE, MULTI SETTING and MASTER/SLAVE MODE, which will switch the PC to corresponding screen after the software is started.

6.1 Software Installation

To ensure the normal operation of our monitoring software, your PC must have the following:

1. Pentium IV microprocessor or higher;
2. Windows XP Service Pack 2 operating system or higher.

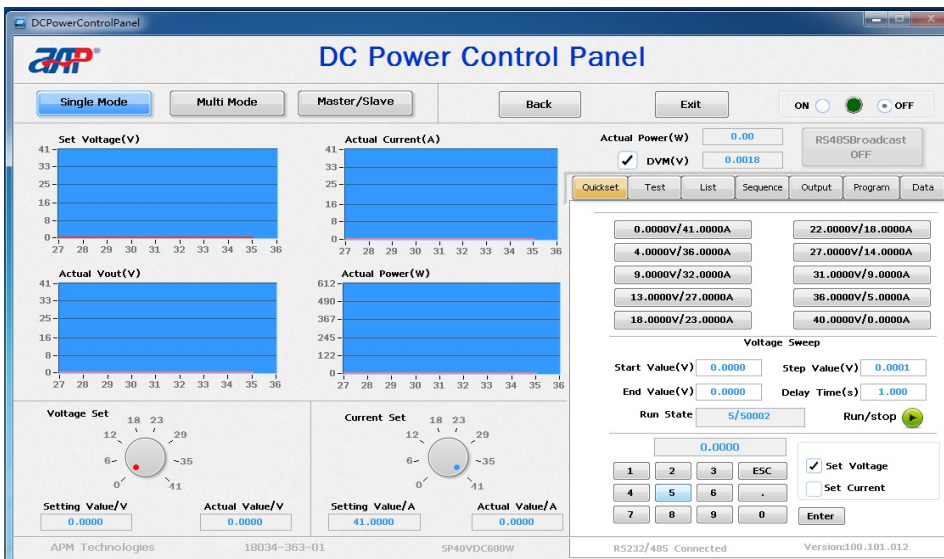

Please visit <http://enpps.apmtech.cn/html/service/down/> and download the monitoring software in Application & Software part.

7 Troubleshooting

Problem	Causes	Solutions
Inaccurate measurement of V, I.	Drift of parts values lead to inaccuracies.	Units require regular calibration to allow accurate measurement.
Output is not within the scope of accuracy.	Drift of parts values lead to inaccuracies.	Units require regular calibration to allow accurate settings.
Over temperature protection (OTP) activates.	<ol style="list-style-type: none"> 1. Ambient temperature is too high. 2. Ventilation holes are blocked. 	<ol style="list-style-type: none"> 1. Reduce ambient temperature. 2. Unblock vents, remove dust.
Over power protection (OPP) activates.	Output power is exceeds the setting.	Remove overload or adjust OPP setting.
Over current protection (OCP) activates.	Output current exceeds the specifications or OCP setting value.	Remove overload or adjust OCP setting.
Fan failure protection (FAN FAULT) activates.	Fan failure.	If you can't reset the protection status, ask your agent for help with fan replacement.
Software Version Conflict.	The Power supplies can not work in Master/Slave mode.	Ask your agent for help.
Over voltage protection (OVP) activates.	Output voltage exceeds the specifications or OVP setting value.	<ol style="list-style-type: none"> 1. Adjust the OVP setting value. 2. If you can't reset the protection status, ask your agent for help.
Short Circuit protection activates.	Output wires are short-circuited or the loads connected to the power are short-circuited.	Turn off the output and check the cables to ensure they are properly connected before turning the power back on.
Power supply can not work (PRIMARY_FAIL)	Primary input voltage is over or under the required input voltage range.	Turn off the output and check the AC input to ensure the voltage is meet the requirement.
	Primary temperature is too high.	Turn off the output and check the ambient temperature is appropriate.
	PFC does not work or Bus current is over current.	Turn off the output, unpack the top cover and check the Bus voltage is 400VDC, you'd better ask your agent for help.

8 Installation

8.1 Product Dimensions

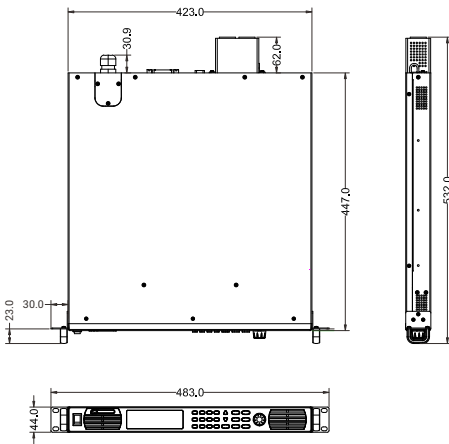

Outline Diagram of 1U units (mm)

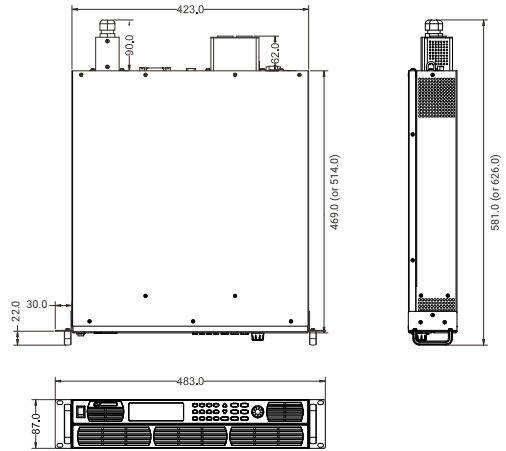

Outline Diagram of 2U units (mm)

Note: refer to appendix A to get the detailed information about the dimensions of power supplies.

8.2 Shelf Mounting Diagram of DC Power Supply

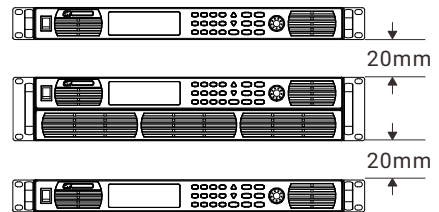
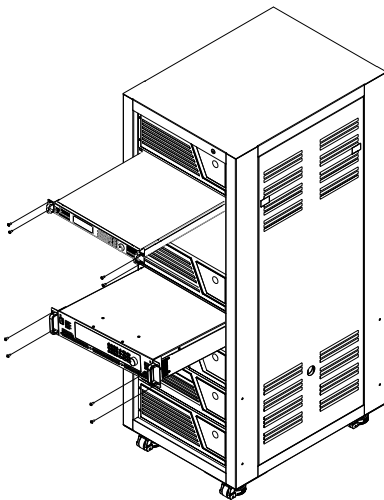

This series of programmable DC power can be installed in a standard 19-inch equipment rack, and it is easy to integrate into your test system.

To leave minimum clearance between power and power or power and other equipment for cooling as above.

8.3 Assemble Rack Mount Brackets

Rack mount brackets must be assembled before mounting the unit in a rack. Refer to the figure on the right to assemble the rack mount brackets.

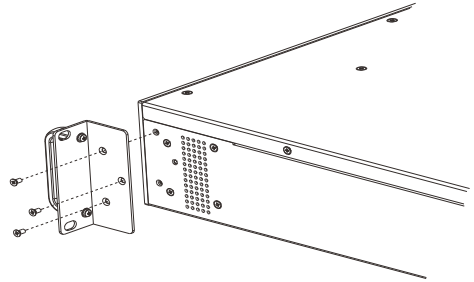

9 Recycling and Disposal

Do not discard this device and its accessories as solid waste. Please contact your local government agencies to find out how to properly recycle the product properly.

10 Contact Us

If you have any questions about the SP-1U/2U Series High Performance Programmable DC Power Supply, please contact us. We will be happy to answer any of your questions. Below are our contact details:

APM Technologies

Add: # 7, Link Information Industry Park, Shuilianshan Road, Nancheng, Dongguan, Guangdong, China

Land line: +86-769 22028588

Fax: +86-769 22026771

Website: www.apmtech.cn

E-mail: mk@apmtech.cn

Appendix A Specifications

● 600W in 1U

Model	SP20VDC600W	SP32VDC600W	SP40VDC600W	SP75VDC600W	SP150VDC600W	SP200VDC600W
Input						
Input Voltage	90~265VAC					
Input Frequency	47~63Hz					
Power Factor	>0.98					
Input Power	750VA(MAX)					
Output						
Output Voltage Range	0~20V	0~32V	0~40V	0~75V	0~150V	0~200V
Output Current Range	0~60A	0~50A	0~40A	0~25A	0~10A	0~8A
Output Power Range	0~600W					
Voltage Load Regulation	10mV	10mV	10mV	10mV	15mV	15mV
Current Load Regulation	60mA	50mA	40mA	25mA	10mA	8mA
Voltage Display Resolution	0.1mV	0.1mV	0.1mV	0.1mV	1mV	1mV
Current Display Resolution	0.2mA	0.2mA	0.2mA	0.2mA	0.2mA	0.1mA
Voltage Programmable Resolution	1.5mV	1.5mV	1.5mV	1.5mV	3mV	3mV
Current Programmable Resolution	2mA	2mA	2mA	1mA	1mA	1mA
Voltage Setting Accuracy ⁽¹⁾	0.05%+15mV	0.05%+15mV	0.05%+15mV	0.05%+15mV	0.1%+15mV	0.1%+15mV
Current Setting Accuracy	0.1%+60mA	0.1%+50mA	0.1%+40mA	0.1%+25mA	0.1%+10mA	0.1%+8mA
Voltage Measurement Accuracy ⁽²⁾	0.05%+15mV	0.05%+15mV	0.05%+15mV	0.05%+15mV	0.1%+15mV	0.1%+15mV
Current Measurement Accuracy	0.1%+60mA	0.1%+50mA	0.1%+40mA	0.1%+25mA	0.1%+10mA	0.1%+8mA
Voltage Ripple ⁽³⁾	40mVp-p 6mVrms	40mVp-p 6mVrms	40mVp-p 6mVrms	40mVp-p 6mVrms	120mVp-p 40mVrms	120mVp-p 40mVrms
Current Ripple ⁽⁴⁾	60mA (Full Range) 20mA (TYP Value)	50mA (Full Range) 20mA (TYP Value)	40mA (Full Range) 20mA (TYP Value)	25mA (Full Range) 10mA (TYP Value)	40mA (Full Range) 10mA (TYP Value)	40mA (Full Range) 10mA (TYP Value)
Line Regulation(Voltage)	0.005%+1mV	0.005%+1mV	0.005%+1mV	0.005%+1mV	0.02%+8mV	0.02%+8mV
Line Regulation(Current)	4mA	4mA	4mA	4mA	10mA	30mA
Voltage Temperature Coefficient ⁽⁵⁾	100ppm/°C					
Current Temperature Coefficient ⁽⁶⁾	150ppm/°C					
DVM Resolution	0.1mV	0.1mV	0.1mV	0.1mV	4mV	1mV
DVM Precision ⁽⁷⁾	0.05%+15mV	0.05%+15mV	0.05%+15mV	0.05%+15mV	0.1%+30mV	0.1%+15mV
Operating Mode	Constant voltage (CV) / Constant current (CC)					
Remote Compensation	4V MAX					
Master-slave Control	Yes					
Response (Voltage Increase)	≤10ms	≤12ms	≤10ms	≤10ms	≤25ms	≤30ms
Response (Voltage Drop)	≤150ms (no load) ≤20ms (full load)	≤150ms (no load) ≤20ms (full load)	≤150ms (no load) ≤20ms (full load)	≤160ms (no load) ≤20ms (full load)	≤400ms (no load) ≤32ms (full load)	≤600ms (no load) ≤30ms (full load)
Load Transient Recovery Time ⁽⁸⁾	≤2ms	≤2ms	≤2ms	≤2ms	≤3ms	≤3ms
Command Response Time	50ms					
Series Capability ⁽⁹⁾	Up to 10 units	Up to 10 units	Up to 10 units	Up to 10 units	Up to 8 units	Up to 6 units
Parallel Capability	Up to 10 units					
Current Sharing ⁽¹⁰⁾	9V	9V	12V	20V	40V	50V
Efficiency (full load)	85%	86%	87%	88%	88%	87%
Other						
Protection Function	OVP/OC/OTP/OPP/SCP/FOLDBACK					
Anti Reverse Irrigation Protection	Yes					
Input Fuse	20A, 125VAC/250VAC, fast-acting type	30A, 125VAC/250VAC, fast-acting type	30A, 125VAC/250VAC, fast-acting type	30A, 125VAC/250VAC, fast-acting type	10A, 125VAC/250VAC, fast-acting type	10A, 125VAC/250VAC, fast-acting type
Unit Weight/Shipping Weight	9.2kg/12kg	9.2kg/12kg	9.2kg/12kg	8.9kg/11.7kg	9.3kg/12.7kg	9.3kg/12.7kg
Dimensions(WxHxD)	423.0x44.0x447.0 mm					
Communication Modes	1. RS232/RS485/USB/LAN; 2. RS232/RS485/USB/LAN/GPIB					
Operating Environment	Temperature 0~40°C, Relative Humidity 10%~90%(no condensation); Pollution degree 2, Installation category II, Indoor use.					
Cooling Mode	Forced air-cooling					
Altitude	2000m					
Insulation	AC input ↔DC output, 4242VDC, AC input ↔ PE, 2121VDC					

● 1000W in 1U

Model	SP20VDC1000W	SP32VDC1000W	SP40VDC1000W	SP75VDC1000W	SP150VDC1000W	SP200VDC1000W
Input						
Input Voltage	90~265VAC					
Input Frequency	47~63Hz					
Power Factor	>0.98					
Input Power	1300VA(MAX)					
Output						
Output Voltage Range	0~20V	0~32V	0~40V	0~75V	0~150V	0~200V
Output Current Range	0~60A	0~50A	0~40A	0~25A	0~10A	0~8A
Output Power Range	0~1000W					
Voltage Load Regulation	10mV	10mV	10mV	10mV	15mV	15mV
Current Load Regulation	60mA	50mA	40mA	25mA	10mA	8mA
Voltage Display Resolution	0.1mV	0.1mV	0.1mV	0.1mV	1mV	1mV
Current Display Resolution	0.2mA	0.2mA	0.2mA	0.2mA	0.2mA	0.1mA
Voltage Programmable Resolution	1.5mV	1.5mV	1.5mV	1.5mV	3mV	3mV
Current Programmable Resolution	2mA	2mA	2mA	1mA	1mA	1mA
Voltage Setting Accuracy ^[1]	0.05%+15mV	0.05%+15mV	0.05%+15mV	0.05%+15mV	0.1%+15mV	0.1%+15mV
Current Setting Accuracy	0.1%+60mA	0.1%+50mA	0.1%+40mA	0.1%+25mA	0.1%+10mA	0.1%+8mA
Voltage Measurement Accuracy ^[1]	0.05%+15mV	0.05%+15mV	0.05%+15mV	0.05%+15mV	0.1%+15mV	0.1%+15mV
Current Measurement Accuracy	0.1%+60mA	0.1%+50mA	0.1%+40mA	0.1%+25mA	0.1%+10mA	0.1%+8mA
Voltage Ripple ^[2]	40mVp-p 6mVrms	40mVp-p 6mVrms	40mVp-p 6mVrms	40mVp-p 6mVrms	120mVp-p 40mVrms	120mVp-p 40mVrms
Current Ripple ^[2]	60mA (Full Range) 20mA (TYP Value)	50mA (Full Range) 20mA (TYP Value)	40mA (Full Range) 20mA (TYP Value)	25mA (Full Range) 10mA (TYP Value)	40mA (Full Range) 10mA (TYP Value)	40mA (Full Range) 10mA (TYP Value)
Line Regulation(Voltage)	0.005%+1mV	0.005%+1mV	0.005%+1mV	0.005%+1mV	0.02%+8mV	0.02%+8mV
Line Regulation(Current)	4mA	4mA	4mA	4mA	10mA	30mA
Voltage Temperature Coefficient ^[4]	100ppm/°C					
Current Temperature Coefficient ^[4]	150ppm/°C					
DVM Resolution	0.1mV	0.1mV	0.1mV	0.1mV	4mV	1mV
DVM Precision ^[1]	0.05%+15mV	0.05%+15mV	0.05%+15mV	0.05%+15mV	0.1%+30mV	0.1%+15mV
Operating Mode	Constant voltage (CV) / Constant current (CC)					
Remote Compensation	4V MAX					
Master-slave Control	Yes					
Response (Voltage Increase)	≤10ms	≤12ms	≤10ms	≤10ms	≤25ms	≤30ms
Response (Voltage Drop)	≤150ms (no load) ≤20ms (full load)	≤150ms (no load) ≤15ms (full load)	≤150ms (no load) ≤15ms (full load)	≤160ms (no load) ≤15ms (full load)	≤400ms (no load) ≤25ms (full load)	≤600ms (no load) ≤40ms (full load)
Load Transient Recovery Time ^[3]	≤2ms	≤2ms	≤2ms	≤2ms	≤3ms	≤3ms
Command Response Time	50ms					
Series Capability ^[5]	Up to 10 units	Up to 10 units	Up to 10 units	Up to 10 units	Up to 8 units	Up to 6 units
Parallel Capability	Up to 10 units					
Current Sharing ^[7]	9V	9V	12V	20V	40V	50V
Efficiency (full load)	85%	89%	89%	89%	89%	87%
Other						
Protection Function	OVP/OC/OTP/OPP/SCP/FOLDBACK					
Anti Reverse Irrigation Protection	Yes					
Input Fuse	20A, 125VAC/250VAC, fast-acting type	30A, 125VAC/250VAC, fast-acting type	30A, 125VAC/250VAC, fast-acting type	30A, 125VAC/250VAC, fast-acting type	30A, 125VAC/250VAC, fast-acting type	30A, 125VAC/250VAC, fast-acting type
Unit Weight/Shipping Weight	9.2kg/12kg	9.2kg/12kg	9.2kg/12kg	8.9kg/11.7kg	9.3kg/12.7kg	9.3kg/12.7kg
Dimensions(WxHxD)	423.0x44.0x447.0 mm					
Communication Modes	1. RS232/RS485/USB/LAN; 2. RS232/RS485/USB/LAN/GPIB					
Operating Environment	Temperature 0~40°C, Relative Humidity 10%~90%(no condensation); Pollution degree 2, Installation category II, Indoor use.					
Cooling Mode	Forced air-cooling					
Altitude	2000m					
Insulation	AC input <->DC output, 4242VDC, AC input <-> PE, 2121VDC					

● 1200W in 1U

Model	SP20VDC1200W	SP32VDC1200W	SP40VDC1200W	SP75VDC1200W	SP150VDC1200W	SP200VDC1200W
Input						
Input Voltage	90~265VAC					
Input Frequency	47~63Hz					
Power Factor	>0.98					
Input Power	1500VA(MAX)					
Output						
Output Voltage Range	0~20V	0~32V	0~40V	0~75V	0~150V	0~200V
Output Current Range	0~60A	0~50A	0~40A	0~25A	0~10A	0~8A
Output Power Range	0~1200W					
Voltage Load Regulation	10mV	10mV	10mV	10mV	15mV	15mV
Current Load Regulation	60mA	50mA	40mA	25mA	10mA	8mA
Voltage Display Resolution	0.1mV	0.1mV	0.1mV	0.1mV	1mV	1mV
Current Display Resolution	0.2mA	0.2mA	0.2mA	0.2mA	0.2mA	0.1mA
Voltage Programmable Resolution	1.5mV	1.5mV	1.5mV	1.5mV	3mV	3mV
Current Programmable Resolution	2mA	2mA	2mA	1mA	1mA	1mA
Voltage Setting Accuracy ^[1]	0.05%+15mV	0.05%+15mV	0.05%+15mV	0.05%+15mV	0.1%+15mV	0.1%+15mV
Current Setting Accuracy	0.1%+60mA	0.1%+50mA	0.1%+40mA	0.1%+25mA	0.1%+10mA	0.1%+8mA
Voltage Measurement Accuracy ^[1]	0.05%+15mV	0.05%+15mV	0.05%+15mV	0.05%+15mV	0.1%+15mV	0.1%+15mV
Current Measurement Accuracy	0.1%+60mA	0.1%+50mA	0.1%+40mA	0.1%+25mA	0.1%+10mA	0.1%+8mA
Voltage Ripple ^[2]	40mVp-p 6mVrms	40mVp-p 6mVrms	40mVp-p 6mVrms	40mVp-p 6mVrms	120mVp-p 40mVrms	120mVp-p 40mVrms
Current Ripple ^[2]	60mA (Full Range) 20mA (TYP Value)	50mA (Full Range) 20mA (TYP Value)	40mA (Full Range) 20mA (TYP Value)	25mA (Full Range) 10mA (TYP Value)	40mA (Full Range) 10mA (TYP Value)	40mA (Full Range) 10mA (TYP Value)
Line Regulation(Voltage)	0.005%+1mV	0.005%+1mV	0.005%+1mV	0.005%+1mV	0.02%+8mV	0.02%+8mV
Line Regulation(Current)	4mA	4mA	4mA	4mA	10mA	30mA
Voltage Temperature Coefficient ^[6]	100ppm/°C					
Current Temperature Coefficient ^[6]	150ppm/°C					
DVM Resolution	0.1mV	0.1mV	0.1mV	0.1mV	4mV	1mV
DVM Precision ^[1]	0.05%+15mV	0.05%+15mV	0.05%+15mV	0.05%+15mV	0.1%+30mV	0.1%+15mV
Operating Mode	Constant voltage (CV) / Constant current (CC)					
Remote Compensation	4V MAX					
Master-slave Control	Yes					
Response (Voltage Increase)	≤10ms	≤10ms	≤10ms	≤10ms	≤25ms	≤30ms
Response (Voltage Drop)	≤150ms (no load) ≤12ms (full load)	≤150ms (no load) ≤12ms (full load)	≤150ms (no load) ≤12ms (full load)	≤160ms (no load) ≤12ms (full load)	≤400ms (no load) ≤21ms (full load)	≤600ms (no load) ≤36ms (full load)
Load Transient Recovery Time ^[3]	≤2ms	≤2ms	≤2ms	≤2ms	≤3ms	≤3ms
Command Response Time	50ms					
Series Capability ^[6]	Up to 10 units	Up to 10 units	Up to 10 units	Up to 10 units	Up to 8 units	Up to 6 units
Parallel Capability	Up to 10 units					
Current Sharing ^[7]	9V	9V	12V	20V	40V	50V
Efficiency (full load)	84%	84%	89%	90%	89%	90%
Other						
Protection Function	OVP/OCV/OTP/OPP/SCP/FOLDBACK					
Anti Reverse Irrigation Protection	Yes					
Input Fuse	20A, 125VAC/250VAC, fast-acting type	20A, 125VAC/250VAC, fast-acting type	30A, 125VAC/250VAC, fast-acting type	30A, 125VAC/250VAC, fast-acting type	30A, 125VAC/250VAC, fast-acting type	30A, 125VAC/250VAC, fast-acting type
Unit Weight/Shipping Weight	9.2kg/12kg	9.2kg/12kg	9.2kg/12kg	8.9kg/11.7kg	9.3kg/12.7kg	9.3kg/12.7kg
Dimensions(WxHxD)	423.0x44.0x447.0 mm					
Communication Modes	1. RS232/RS485/USB/LAN; 2. RS232/RS485/USB/LAN/GPIB					
Operating Environment	Temperature 0~40°C, Relative Humidity 10%~90%(no condensation); Pollution degree 2, Installation category II, Indoor use.					
Cooling Mode	Forced air-cooling					
Altitude	2000m					
Insulation	AC input <->DC output, 4242VDC, AC input <-> PE, 2121VDC					

● 1500W in 1U

Model	SP75VDC1500W	SP150VDC1500W	SP200VDC1500W
Input			
Input Voltage	90~265VAC		
Input Frequency	47~63Hz		
Power Factor	>0.98		
Input Power	1900VA(MAX)		
Output			
Output Voltage Range	0~75V	0~150V	0~200V
Output Current Range	0~25A	0~10A	0~8A
Output Power Range	0~1500W		
Voltage Load Regulation	10mV	15mV	15mV
Current Load Regulation	25mA	10mA	8mA
Voltage Display Resolution	0.1mV	1mV	1mV
Current Display Resolution	0.2mA	0.2mA	0.1mA
Voltage Programmable Resolution	1.5mV	3mV	3mV
Current Programmable Resolution	1mA	1mA	1mA
Voltage Setting Accuracy ^[1]	0.05%+15mV	0.05%+15mV	0.05%+15mV
Current Setting Accuracy	0.1%+25mA	0.1%+10mA	0.1%+8mA
Voltage Measurement Accuracy ^[1]	0.05%+15mV	0.1%+15mV	0.1%+15mV
Current Measurement Accuracy	0.1%+25mA	0.1%+10mA	0.1%+8mA
Voltage Ripple ^[2]	40mVp-p 6mVrms	120mVp-p 40mVrms	120mVp-p 40mVrms
Current Ripple ^[2]	25mA (Full Range) 10mA (TYP Value)	40mA (Full Range) 10mA (TYP Value)	40mA (Full Range) 10mA (TYP Value)
Line Regulation(Voltage)	0.005%+2mV	0.02%+8mV	0.02%+8mV
Line Regulation(Current)	4mA	10mA	30mA
Voltage Temperature Coefficient ^[6]	100ppm/°C		
Current Temperature Coefficient ^[6]	150ppm/°C		
DVM Resolution	0.1mV	4mV	1mV
DVM Precision ^[1]	0.05%+15mV	0.1%+30mV	0.1%+15mV
Operating Mode	Constant voltage (CV) / Constant current (CC)		
Remote Compensation	4V MAX		
Master-slave Control	Yes		
Response (Voltage Increase)	≤10ms	≤25ms	≤30ms
Response (Voltage Drop)	≤160ms (no load) ≤10ms (full load)	≤400ms (no load) ≤18ms (full load)	≤600ms (no load) ≤30ms (full load)
Load Transient Recovery Time ^[8]	≤2ms	≤3ms	≤3ms
Command Response Time	50ms		
Series Capability ^[9]	Up to 10 units	Up to 8 units	Up to 6 units
Parallel Capability	Up to 10 units		
Current Sharing ^[7]	20V	40V	50V
Efficiency (full load)	91%	90%	91%
Other			
Protection Function	OVP/OCP/OTP/OPP/SCP/FOLDBACK		
Anti Reverse Irrigation Protection	Yes		
Input Fuse	30A, 125VAC/250VAC, fast-acting type		
Unit Weight/Shipping Weight	8.9kg/11.7kg	9.3kg/12.7kg	9.3kg/12.7kg
Dimensions(WxHxD)	423.0x44.0x447.0 mm		
Communication Modes	1. RS232/RS485/USB/LAN; 2. RS232/RS485/USB/LAN/GPIB		
Operating Environment	Temperature 0~40°C, Relative Humidity 10%~90%(no condensation); Pollution degree 2, Installation category II, Indoor use.		
Cooling Mode	Forced air-cooling		
Altitude	2000m		
Insulation	AC input <->DC output, 4242VDC, AC input <-> PE, 2121VDC		

● 1600W in 1U

Model	SP32VDC1600W	SP40VDC1600W
Input		
Input Voltage	90~265VAC	
Input Frequency	47~63Hz	
Power Factor	>0.98	
Input Power	2000VA(MAX)	
Output		
Output Voltage Range	0~32V	0~40V
Output Current Range	0~50A	0~40A
Output Power Range	0~1600W	
Voltage Load Regulation	10mV	
Current Load Regulation	50mA	40mA
Voltage Display Resolution	0.1mV	
Current Display Resolution	0.2mA	
Voltage Programmable Resolution	1.5mV	
Current Programmable Resolution	2mA	
Voltage Setting Accuracy ^[1]	0.05%+15mV	
Current Setting Accuracy	0.1%+50mA	0.1%+40mA
Voltage Measurement Accuracy ^[1]	0.05%+15mV	
Current Measurement Accuracy	0.1%+50mA	0.1%+40mA
Voltage Ripple ^[5]	40mVp-p 6mVrms	
Current Ripple ^[5]	50mA (Full Range) 20mA (TYP Value)	40mA (Full Range) 20mA (TYP Value)
Line Regulation(Voltage)	0.005%+1mV	
Line Regulation(Current)	4mA	
Voltage Temperature Coefficient ^[6]	100ppm/°C	
Current Temperature Coefficient ^[6]	150ppm/°C	
DVM Resolution	0.1mV	
DVM Precision ^[1]	0.05%+15mV	
Operating Mode	Constant voltage (CV) / Constant current (CC)	
Remote Compensation	4V MAX	
Master-slave Control	Yes	
Response (Voltage Increase)	≤12ms	≤10ms
Response (Voltage Drop)	≤150ms (no load) ≤10ms (full load)	
Load Transient Recovery Time ^[5]	≤2ms	
Command Response Time	50ms	
Series Capability ^[5]	Up to 10 units	
Parallel Capability	Up to 10 units	
Current Sharing ^[7]	9V	12V
Efficiency (full load)	89%	90%
Other		
Protection Function	OVP/OCP/OTP/OPP/SCP/FOLDBACK	
Anti Reverse Irrigation Protection	Yes	
Input Fuse	30A, 125VAC/250VAC, fast-acting type	
Unit Weight/Shipping Weight	9.2kg/12kg	
Dimensions(WxHxD)	423.0x44.0x447.0 mm	
Communication Modes	1. RS232/RS485/USB/LAN; 2. RS232/RS485/USB/LAN/GPIB	
Operating Environment	Temperature 0~40°C, Relative Humidity 10%~90%(no condensation); Pollution degree 2, Installation category II, Indoor use.	
Cooling Mode	Forced air-cooling	
Altitude	2000m	
Insulation	AC input <->DC output, 4242VDC, AC input <-> PE, 2121VDC	

● 1000W in 2U(1)

Model	SPS32VDC1000W	SPS40VDC1000W	SPS80VDC1000W	SPS120VDC1000W
Input				
Input Voltage	90~265VAC			
Input Frequency	47~63Hz			
Power Factor	>0.98	>0.98	>0.97	>0.98
Input Power	1500VA(MAX)	1300VA(MAX)	1200VA(MAX)	1300VA(MAX)
Output				
Output Voltage Range	0~32V	0~40V	0~80V	0~120V
Output Current Range	0~200A	0~120A	0~60A	0~40A
Output Power Range	0~1000W			
Voltage Load Regulation	30mV	15mV	15mV	15mV
Current Load Regulation	200mA	120mA	60mA	40mA
Voltage Display Resolution	0.1mV	0.1mV	0.1mV	1mV
Current Display Resolution	1mA	1mA	0.2mA	0.1mA
Voltage Programmable Resolution	1mV	1mV	1.5mV	3mV
Current Programmable Resolution	6mA	3mA	2mA	1mA
Voltage Setting Accuracy ^[1]	0.05%+15mV	0.05%+15mV	0.05%+15mV	0.1%+15mV
Current Setting Accuracy	0.1%+200mA	0.1%+120mA	0.1%+60mA	0.1%+40mA
Voltage Measurement Accuracy ^[2]	0.05%+15mV	0.05%+15mV	0.05%+15mV	0.1%+15mV
Current Measurement Accuracy	0.1%+200mA	0.1%+120mA	0.1%+60mA	0.1%+40mA
Voltage Ripple ^[3]	60mVp-p 10mVrms	40mVp-p 6mVrms	40mVp-p 6mVrms	80mVp-p 15mVrms
Current Ripple ^[3]	400mA (Full Range) 200mA (TYP Value)	150mA (Full Range) 20mA (TYP Value)	50mA (Full Range) 10mA (TYP Value)	60mA (Full Range) 10mA (TYP Value)
Line Regulation(Voltage)	0.01%+8mV	0.02%+8mV	0.01%+8mV	0.02%+8mV
Line Regulation(Current)	200mA	30mA	30mA	40mA
Voltage Temperature Coefficient ^[4]	100ppm/°C			
Current Temperature Coefficient ^[4]	150ppm/°C			
DVM Resolution	0.1mV	0.1mV	0.1mV	1mV
DVM Precision ^[1]	0.05%+15mV	0.05%+15mV	0.05%+15mV	0.1%+15mV
Operating Mode	Constant voltage (CV) / Constant current (CC)			
Remote Compensation	4V MAX	4V MAX	4V MAX	5V MAX
Master-slave Control	Yes			
Response (Voltage Increase)	≤20ms (no load) ≤40ms (full load)	≤10ms	≤15ms	≤20ms
Response (Voltage Drop)	≤500ms (no load) ≤45ms (full load)	≤350ms (no load) ≤10ms (full load)	≤450ms (no load) ≤30ms (full load)	≤350ms (no load) ≤21ms (full load)
Load Transient Recovery Time ^[5]	≤2ms			
Command Response Time	50ms			
Series Capability ^[6]	Up to 10 units			
Parallel Capability	Up to 10 units			
Current Sharing ^[7]	12V	12V	20V	30V
Efficiency (full load)	85%	87%	89%	88%
Other				
Protection Function	OVP/OCP/OTP/OPP/SCP/FOLDBACK			
Anti Reverse Irrigation Protection	No(customers can purchase other accessories to achieve this function, please consult the salesrepresentative for details)	Yes	Yes	Yes
Input Fuse	20A, 125VAC/250VAC, fast-acting type	30A, 125VAC/250VAC, fast-acting type	30A, 125VAC/250VAC, fast-acting type	30A, 125VAC/250VAC, fast-acting type
Unit Weight/Shipping Weight	14.7kg/18.7kg	14.7kg/18.7kg	13.2kg/16.8kg	13.2kg/16.8kg
Dimensions(WxHxD)	423.0x87.0x514.0 mm	423.0x87.0x514.0 mm	423.0x87.0x469.0 mm	423.0x87.0x469.0 mm
Communication Modes	1. RS232/RS485/USB/LAN; 2. RS232/RS485/USB/LAN/GPIB			
Operating Environment	Temperature 0~40°C, Relative Humidity 10%~90%(no condensation); Pollution degree 2, Installation category II, Indoor use.			
Cooling Mode	Forced air-cooling			
Altitude	2000m			
Insulation	AC input <->DC output, 4242VDC, AC input <-> PE, 2121VDC			

● 1000W in 2U(2)

Model	SPS150VDC1000W	SPS200VDC1000W	SPS600VDC1000W	SPS800VDC1000W
Input				
Input Voltage	90~265VAC			
Input Frequency	47~63Hz			
Power Factor	>0.98			
Input Power	1300VA(MAX)			
Output				
Output Voltage Range	0~150V	0~200V	0~600V	0~800V
Output Current Range	0~30A	0~24A	0~10A	0~7.5A
Output Power Range	0~1000W			
Voltage Load Regulation	15mV	15mV	30mV	200mV
Current Load Regulation	30mA	24mA	10mA	20mA
Voltage Display Resolution	1mV			
Current Display Resolution	0.1mA			
Voltage Programmable Resolution	3mV	4mV	12mV	24mV
Current Programmable Resolution	1mA			
Voltage Setting Accuracy ^[1]	0.1%+15mV	0.1%+15mV	0.05%+150mV	0.05%+200mV
Current Setting Accuracy	0.1%+30mA	0.1%+24mA	0.1%+10mA	0.1%+7.5mA
Voltage Measurement Accuracy ^[2]	0.1%+15mV	0.1%+15mV	0.05%+150mV	0.05%+200mV
Current Measurement Accuracy	0.1%+30mA	0.1%+24mA	0.1%+10mA	0.1%+7.5mA
Voltage Ripple ^[3]	80mVp-p 15mVrms	150mVp-p 30mVrms	350mVp-p 40mVrms	800mVp-p 200mVrms
Current Ripple ^[3]	60mA (Full Range) 10mA (TYP Value)	50mA (Full Range) 20mA (TYP Value)	25mA (Full Range) 10mA (TYP Value)	25mA (Full Range) 10mA (TYP Value)
Line Regulation(Voltage)	0.02%+8mV	0.02%+8mV	0.01%+30mV	0.01%+40mV
Line Regulation(Current)	30mA	30mA	15mA	15mA
Voltage Temperature Coefficient ^[4]	100ppm/°C			
Current Temperature Coefficient ^[4]	150ppm/°C			
DVM Resolution	1mV	1mV	12mV	12mV
DVM Precision ^[1]	0.1%+15mV	0.1%+15mV	0.05%+150mV	0.05%+200mV
Operating Mode	Constant voltage (CV) / Constant current (CC)			
Remote Compensation	5V MAX			
Master-slave Control	Yes			
Response (Voltage Increase)	≤25ms	≤30ms	≤60ms	≤60ms
Response (Voltage Drop)	≤500ms (no load) ≤25ms (full load)	≤500ms (no load) ≤35ms (full load)	≤800ms (no load) ≤110ms (full load)	≤800ms (no load) ≤60ms (full load)
Load Transient Recovery Time ^[5]	≤2ms	≤2ms	≤3ms	≤3ms
Command Response Time	50ms			
Series Capability ^[6]	Up to 8 units	Up to 6 units	Up to 2 units	Not Recommended
Parallel Capability	Up to 10 units			
Current Sharing ^[7]	40V	50V	200V	250V
Efficiency (full load)	88%	88%	86%	85%
Other				
Protection Function	OVP/OCP/OTP/OPP/SCP/FOLDBACK			
Anti Reverse Irrigation Protection	Yes			
Input Fuse	30A, 125VAC/250VAC, fast-acting type			
Unit Weight/Shipping Weight	13.2kg/16.8kg	14.7kg/18.7kg	13.2kg/16.8kg	13.2kg/16.8kg
Dimensions(WxHxD)	423.0x87.0x469.0 mm	423.0x87.0x469.0 mm	423.0x87.0x514.0 mm	423.0x87.0x514.0 mm
Communication Modes	1. RS232/RS485/USB/LAN; 2. RS232/RS485/USB/LAN/GPIB			
Operating Environment	Temperature 0~40°C, Relative Humidity 10%~90%(no condensation); Pollution degree 2, Installation category II, Indoor use.			
Cooling Mode	Forced air-cooling			
Altitude	2000m			
Insulation	AC input <-> DC output, 4242VDC, AC input <-> PE, 2121VDC			

● 2000W in 2U(1)

Model	SP32VDC2000W	SP40VDC2000W	SP80VDC2000W	SP120VDC2000W
Input				
Input Voltage	190~265VAC			
Input Frequency	47~63Hz			
Power Factor	>0.98			
Input Power	2600VA(MAX)	2400VA(MAX)	2400VA(MAX)	2400VA(MAX)
Output				
Output Voltage Range	0~32V	0~40V	0~80V	0~120V
Output Current Range	0~200A	0~120A	0~60A	0~40A
Output Power Range	0~2000W			
Voltage Load Regulation	30mV	15mV	15mV	15mV
Current Load Regulation	200mA	120mA	60mA	40mA
Voltage Display Resolution	0.1mV	0.1mV	0.1mV	1mV
Current Display Resolution	1mA	1mA	0.2mA	0.1mA
Voltage Programmable Resolution	1mV	1mV	1.5mV	3mV
Current Programmable Resolution	6mA	3mA	2mA	1mA
Voltage Setting Accuracy ^[1]	0.05%+15mV	0.05%+15mV	0.05%+15mV	0.1%+15mV
Current Setting Accuracy	0.1%+200mA	0.1%+120mA	0.1%+60mA	0.1%+40mA
Voltage Measurement Accuracy ^[1]	0.05%+15mV	0.05%+15mV	0.05%+15mV	0.1%+15mV
Current Measurement Accuracy	0.1%+200mA	0.1%+120mA	0.1%+60mA	0.1%+40mA
Voltage Ripple ^[2]	60mVp-p 10mVrms	40mVp-p 6mVrms	40mVp-p 6mVrms	80mVp-p 15mVrms
Current Ripple ^[2]	400mA (Full Range) 200mA (TYP Value)	150mA (Full Range) 20mA (TYP Value)	50mA (Full Range) 10mA (TYP Value)	60mA (Full Range) 10mA (TYP Value)
Line Regulation(Voltage)	0.01%+8mV	0.01%+8mV	0.01%+8mV	0.02%+8mV
Line Regulation(Current)	200mA	30mA	30mA	30mA
Voltage Temperature Coefficient ^[6]	100ppm/°C			
Current Temperature Coefficient ^[6]	150ppm/°C			
DVM Resolution	0.1mV	0.1mV	0.1mV	1mV
DVM Precision ^[1]	0.05%+15mV	0.05%+15mV	0.05%+15mV	0.1%+15mV
Operating Mode	Constant voltage (CV) / Constant current (CC)			
Remote Compensation	4V MAX	4V MAX	4V MAX	5V MAX
Master-slave Control	Yes			
Response (Voltage Increase)	≤20ms (no load) ≤30ms (full load)	≤10ms	≤15ms	≤20ms
Response (Voltage Drop)	≤500ms (no load) ≤30ms (full load)	≤350ms (no load) ≤10ms (full load)	≤450ms (no load) ≤30ms (full load)	≤350ms (no load) ≤21ms (full load)
Load Transient Recovery Time ^[8]	≤2ms	≤2ms	≤2ms	≤3ms
Command Response Time	50ms			
Series Capability ^[6]	Up to 10 units	Up to 10 units	Up to 10 units	Up to 8 units
Parallel Capability	Up to 10 units			
Current Sharing ^[7]	12V	12V	20V	30V
Efficiency (full load)	91%	88%	89%	89%
Other				
Protection Function	OVP/OCP/OTP/OPP/SCP/FOLDBACK			
Anti Reverse Irrigation Protection	No(customers can purchase other accessories to achieve this function, please consult the salesrepresentative for details)	Yes	Yes	Yes
Input Fuse	20A, 125VAC/250VAC, fast-acting type	30A, 125VAC/250VAC, fast-acting type	30A, 125VAC/250VAC, fast-acting type	30A, 125VAC/250VAC, fast-acting type
Unit Weight/Shipping Weight	14.7kg/18.7kg	14.7kg/18.7kg	13.2kg/16.8kg	13.2kg/16.8kg
Dimensions(WxHxD)	423.0x87.0x514.0 mm	423.0x87.0x514.0 mm	423.0x87.0x469.0 mm	423.0x87.0x469.0 mm
Communication Modes	1. RS232/RS485/USB/LAN; 2. RS232/RS485/USB/LAN/GPIB			
Operating Environment	Temperature 0~40°C, Relative Humidity 10%~90%(no condensation); Pollution degree 2, Installation category II, Indoor use.			
Cooling Mode	Forced air-cooling			
Altitude	2000m			
Insulation	AC input <->DC output, 4242VDC, AC input <-> PE, 2121VDC			

● 2000W in 2U(2)

Model	SP150VDC2000W	SP200VDC2000W	SP600VDC2000W	SP800VDC2000W
Input				
Input Voltage	190~265VAC			
Input Frequency	47~63Hz			
Power Factor	>0.98			
Input Power	2400VA(MAX)			
Output				
Output Voltage Range	0~150V	0~200V	0~600V	0~800V
Output Current Range	0~30A	0~24A	0~10A	0~7.5A
Output Power Range	0~2000W			
Voltage Load Regulation	15mV	15mV	30mV	200mV
Current Load Regulation	30mA	24mA	10mA	20mA
Voltage Display Resolution	1mV			
Current Display Resolution	0.1mA			
Voltage Programmable Resolution	3mV	4mV	12mV	24mV
Current Programmable Resolution	1mA			
Voltage Setting Accuracy ^[1]	0.1%+15mV	0.1%+15mV	0.05%+150mV	0.05%+200mV
Current Setting Accuracy	0.1%+30mA	0.1%+24mA	0.1%+10mA	0.1%+7.5mA
Voltage Measurement Accuracy ^[1]	0.1%+15mV	0.1%+15mV	0.05%+150mV	0.05%+200mV
Current Measurement Accuracy	0.1%+30mA	0.1%+24mA	0.1%+10mA	0.1%+7.5mA
Voltage Ripple ^[2]	40mVp-p 6mVrms	150mVp-p 30mVrms	350mVp-p 40mVrms	800mVp-p 200mVrms
Current Ripple ^[2]	60mA (Full Range) 10mA (TYP Value)	50mA (Full Range) 20mA (TYP Value)	25mA (Full Range) 10mA (TYP Value)	25mA (Full Range) 10mA (TYP Value)
Line Regulation(Voltage)	0.02%+8mV	0.02%+8mV	0.01%+30mV	0.01%+40mV
Line Regulation(Current)	30mA	30mA	15mA	20mA
Voltage Temperature Coefficient ^[6]	100ppm/°C			
Current Temperature Coefficient ^[6]	150ppm/°C			
DVM Resolution	1mV	1mV	12mV	12mV
DVM Precision ^[1]	0.1%+15mV	0.1%+15mV	0.05%+150mV	0.05%+200mV
Operating Mode	Constant voltage (CV) / Constant current (CC)			
Remote Compensation	5V MAX			
Master-slave Control	Yes			
Response (Voltage Increase)	≤25ms	≤30ms	≤60ms	≤60ms
Response (Voltage Drop)	≤500ms (no load) ≤25ms (full load)	≤500ms (no load) ≤20ms (full load)	≤800ms (no load) ≤90ms (full load)	≤800ms (no load) ≤60ms (full load)
Load Transient Recovery Time ^[3]	≤3ms			
Command Response Time	50ms			
Series Capability ^[4]	Up to 8 units	Up to 6 units	Up to 2 units	Not Recommended
Parallel Capability	Up to 10 units			
Current Sharing ^[7]	40V	50V	200V	250V
Efficiency (full load)	90%	90%	90%	91%
Other				
Protection Function	OVP/OCP/OTP/OPP/SCP/FOLDBACK			
Anti Reverse Irrigation Protection	Yes			
Input Fuse	30A, 125VAC/250VAC, fast-acting type	30A, 125VAC/250VAC, fast-acting type	20A, 125VAC/250VAC, fast-acting type	20A, 125VAC/250VAC, fast-acting type
Unit Weight/Shipping Weight	13.2kg/16.8kg	13.2kg/16.8kg	14.7kg/18.7kg	14.7kg/18.7kg
Dimensions(WxHxD)	423.0x87.0x469.0 mm	423.0x87.0x469.0 mm	423.0x87.0x514.0 mm	423.0x87.0x514.0 mm
Communication Modes	1. RS232/RS485/USB/LAN; 2. RS232/RS485/USB/LAN/GPIB			
Operating Environment	Temperature 0~40°C, Relative Humidity 10%~90%(no condensation); Pollution degree 2, Installation category II, Indoor use.			
Cooling Mode	Forced air-cooling			
Altitude	2000m			
Insulation	AC input <->DC output, 4242VDC, AC input <-> PE, 2121VDC			

● 3000W in 2U(1)

Model	SP32VDC3000W	SP40VDC3000W	SP80VDC3000W	SP120VDC3000W
Input				
Input Voltage	190~265VAC			
Input Frequency	47~63Hz			
Power Factor	>0.98			
Input Power	3700VA(MAX)	3400VA(MAX)	3400VA(MAX)	3400VA(MAX)
Output				
Output Voltage Range	0~32V	0~40V	0~80V	0~120V
Output Current Range	0~200A	0~120A	0~60A	0~40A
Output Power Range	0~3000W			
Voltage Load Regulation	30mV	15mV	15mV	15mV
Current Load Regulation	200mA	120mA	60mA	40mA
Voltage Display Resolution	0.1mV	0.1mV	0.1mV	1mV
Current Display Resolution	1mA	1mA	0.2mA	0.1mA
Voltage Programmable Resolution	1mV	1mV	1.5mV	3mV
Current Programmable Resolution	6mA	2mA	2mA	1mA
Voltage Setting Accuracy ^[1]	0.05%+15mV	0.05%+15mV	0.05%+15mV	0.1%+15mV
Current Setting Accuracy	0.1%+200mA	0.1%+120mA	0.1%+60mA	0.1%+40mA
Voltage Measurement Accuracy ^[2]	0.05%+15mV	0.05%+15mV	0.05%+15mV	0.1%+15mV
Current Measurement Accuracy	0.1%+200mA	0.1%+120mA	0.1%+60mA	0.1%+40mA
Voltage Ripple ^[3]	60mVp-p 10mVrms	40mVp-p 6mVrms	40mVp-p 6mVrms	80mVp-p 15mVrms
Current Ripple ^[3]	400mA (Full Range) 200mA (TYP Value)	150mA (Full Range) 20mA (TYP Value)	50mA (Full Range) 10mA (TYP Value)	60mA (Full Range) 10mA (TYP Value)
Line Regulation(Voltage)	0.01%+8mV	0.01%+8mV	0.01%+8mV	0.02%+8mV
Line Regulation(Current)	200mA	30mA	30mA	30mA
Voltage Temperature Coefficient ^[6]	100ppm/°C			
Current Temperature Coefficient ^[6]	150ppm/°C			
DVM Resolution	0.1mV	0.1mV	0.1mV	1mV
DVM Precision ^[1]	0.05%+15mV	0.05%+15mV	0.05%+15mV	0.1%+15mV
Operating Mode	Constant voltage (CV) / Constant current (CC)			
Remote Compensation	4V MAX	4V MAX	4V MAX	5V MAX
Master-slave Control	Yes			
Response (Voltage Increase)	≤20ms (no load) ≤20ms (full load)	≤10ms	≤15ms	≤20ms
Response (Voltage Drop)	≤500ms (no load) ≤25ms (full load)	≤350ms (no load) ≤10ms (full load)	≤450ms (no load) ≤30ms (full load)	≤350ms (no load) ≤21ms (full load)
Load Transient Recovery Time ^[8]	≤2ms			
Command Response Time	50ms			
Series Capability ^[9]	Up to 10 units			
Parallel Capability	Up to 10 units			
Current Sharing ^[1]	12V	12V	20V	30V
Efficiency (full load)	91%	88%	91%	91%
Other				
Protection Function	OVP/OCP/OTP/OPP/SCP/FOLDBACK			
Anti Reverse Irrigation Protection	No(customers can purchase other accessories to achieve this function, please consult the salesrepresentative for details)	Yes	Yes	Yes
Input Fuse	30A, 125VAC/250VAC, fast-acting type	40A, 125VAC/250VAC, fast-acting type	40A, 125VAC/250VAC, fast-acting type	40A, 125VAC/250VAC, fast-acting type
Unit Weight/Shipping Weight	14.7kg/18.7kg	14.7kg/18.7kg	13.2kg/16.8kg	13.2kg/16.8kg
Dimensions(WxHxD)	423.0x87.0x514.0 mm	423.0x87.0x514.0 mm	423.0x87.0x469.0 mm	423.0x87.0x469.0 mm
Communication Modes	1. RS232/RS485/USB/LAN; 2. RS232/RS485/USB/LAN/GPIB			
Operating Environment	Temperature 0~40°C, Relative Humidity 10%~90%(no condensation); Pollution degree 2, Installation category II, Indoor use.			
Cooling Mode	Forced air-cooling			
Altitude	2000m			
Insulation	AC input ↔DC output, 4242VDC, AC input ↔ PE, 2121VDC			

● 3000W in 2U(2)

Model	SP150VDC3000W	SP200VDC3000W	SP600VDC3000W	SP800VDC3000W
Input				
Input Voltage	190~265VAC			
Input Frequency	47~63Hz			
Power Factor	>0.98			
Input Power	3400VA(MAX)			
Output				
Output Voltage Range	0~150V	0~200V	0~600V	0~800V
Output Current Range	0~30A	0~24A	0~10A	0~7.5A
Output Power Range	0~3000W			
Voltage Load Regulation	15mV	15mV	30mV	200mV
Current Load Regulation	30mA	24mA	10mA	20mA
Voltage Display Resolution	1mV			
Current Display Resolution	0.1mA			
Voltage Programmable Resolution	3mV	4mV	12mV	24mV
Current Programmable Resolution	1mA			
Voltage Setting Accuracy ^[1]	0.1%+15mV	0.1%+15mV	0.05%+150mV	0.05%+200mV
Current Setting Accuracy	0.1%+30mA	0.1%+24mA	0.1%+10mA	0.1%+7.5mA
Voltage Measurement Accuracy ^[2]	0.1%+15mV	0.1%+15mV	0.05%+150mV	0.05%+200mV
Current Measurement Accuracy	0.1%+30mA	0.1%+24mA	0.1%+10mA	0.1%+7.5mA
Voltage Ripple ^[3]	80mVp-p 15mVrms	150mVp-p 30mVrms	350mVp-p 40mVrms	800mVp-p 200mVrms
Current Ripple ^[3]	60mA (Full Range) 10mA (TYP Value)	50mA (Full Range) 20mA (TYP Value)	25mA (Full Range) 10mA (TYP Value)	25mA (Full Range) 10mA (TYP Value)
Line Regulation(Voltage)	0.02%+8mV	0.02%+8mV	0.01%+30mV	0.01%+40mV
Line Regulation(Current)	30mA	30mA	15mA	20mA
Voltage Temperature Coefficient ^[4]	100ppm/°C			
Current Temperature Coefficient ^[4]	150ppm/°C			
DVM Resolution	1mV	1mV	12mV	12mV
DVM Precision ^[1]	0.1%+15mV	0.1%+15mV	0.05%+150mV	0.05%+200mV
Operating Mode	Constant voltage (CV) / Constant current (CC)			
Remote Compensation	5V MAX			
Master-slave Control	Yes			
Response (Voltage Increase)	≤25ms	≤30ms	≤60ms	≤60ms
Response (Voltage Drop)	≤500ms (no load) ≤25ms (full load)	≤500ms (no load) ≤20ms (full load)	≤800ms (no load) ≤75ms (full load)	≤800ms (no load) ≤60ms (full load)
Load Transient Recovery Time ^[5]	≤2.5ms	≤3ms	≤3ms	≤3ms
Command Response Time	50ms			
Series Capability ^[6]	Up to 8 units	Up to 6 units	Up to 2 units	Not Recommended
Parallel Capability	Up to 10 units			
Current Sharing ^[7]	40V	50V	200V	250V
Efficiency (full load)	92%	91%	91%	91%
Other				
Protection Function	OVP/OCP/OTP/OPP/SCP/FOLDBACK			
Anti Reverse Irrigation Protection	Yes			
Input Fuse	40A, 125VAC/250VAC, fast-acting type	40A, 125VAC/250VAC, fast-acting type	30A, 125VAC/250VAC, fast-acting type	30A, 125VAC/250VAC, fast-acting type
Unit Weight/Shipping Weight	13.2kg/16.8kg	13.2kg/16.8kg	14.7kg/18.7kg	14.7kg/18.7kg
Dimensions(WxHxD)	423.0x87.0x469.0 mm	423.0x87.0x469.0 mm	423.0x87.0x514.0 mm	423.0x87.0x514.0 mm
Communication Modes	1. RS232/RS485/USB/LAN; 2. RS232/RS485/USB/LAN/GPIB			
Operating Environment	Temperature 0~40°C, Relative Humidity 10%~90%(no condensation); Pollution degree 2, Installation category II, Indoor use.			
Cooling Mode	Forced air-cooling			
Altitude	2000m			
Insulation	AC input <-> DC output, 4242VDC, AC input <-> PE, 2121VDC			

● 4000W in 2U(1)

Model	SP32VDC4000W	SP40VDC4000W	SP75VDC4000W	SP120VDC4000W
Input				
Input Voltage	190~265VAC			
Input Frequency	47~63Hz			
Power Factor	>0.98			
Input Power	4800VA(MAX)	4500VA(MAX)	4500VA(MAX)	4500VA(MAX)
Output				
Output Voltage Range	0~32V	0~40V	0~75V	0~120V
Output Current Range	0~200A	0~120A	0~60A	0~40A
Output Power Range	0~4000W			
Voltage Load Regulation	30mV	15mV	15mV	15mV
Current Load Regulation	200mA	120mA	60mA	40mA
Voltage Display Resolution	0.1mV	0.1mV	0.1mV	1mV
Current Display Resolution	1mA	1mA	0.1mA	0.1mA
Voltage Programmable Resolution	1mV	1mV	2mV	3mV
Current Programmable Resolution	6mA	3mA	2mA	1mA
Voltage Setting Accuracy ^[1]	0.05%+15mV	0.05%+15mV	0.1%+15mV	0.1%+15mV
Current Setting Accuracy	0.1%+200mA	0.1%+120mA	0.1%+60mA	0.1%+40mA
Voltage Measurement Accuracy ^[1]	0.05%+15mV	0.05%+15mV	0.1%+15mV	0.1%+15mV
Current Measurement Accuracy	0.1%+200mA	0.1%+120mA	0.1%+60mA	0.1%+40mA
Voltage Ripple ^[2]	60mVp-p 10mVrms	40mVp-p 6mVrms	40mVp-p 8mVrms	80mVp-p 15mVrms
Current Ripple ^[2]	400mA (Full Range) 200mA (TYP Value)	150mA (Full Range) 20mA (TYP Value)	60mA (Full Range) 10mA (TYP Value)	60mA (Full Range) 10mA (TYP Value)
Line Regulation(Voltage)	0.01%+8mV	0.01%+8mV	0.01%+8mV	0.02%+8mV
Line Regulation(Current)	200mA	30mA	30mA	30mA
Voltage Temperature Coefficient ^[6]	100ppm/°C			
Current Temperature Coefficient ^[6]	150ppm/°C			
DVM Resolution	0.1mV	0.1mV	0.1mV	1mV
DVM Precision ^[1]	0.05%+15mV	0.05%+15mV	0.05%+15mV	0.1%+15mV
Operating Mode	Constant voltage (CV) / Constant current (CC)			
Remote Compensation	4V MAX	4V MAX	5V MAX	5V MAX
Master-slave Control	Yes			
Response (Voltage Increase)	≤20ms (no load) ≤20ms (full load)	≤10ms	≤15ms	≤20ms
Response (Voltage Drop)	≤500ms (no load) ≤20ms (full load)	≤350ms (no load) ≤10ms (full load)	≤450ms (no load) ≤20ms (full load)	≤350ms (no load) ≤21ms (full load)
Load Transient Recovery Time ^[3]	≤2ms			
Command Response Time	50ms			
Series Capability ^[6]	Up to 10 units			
Parallel Capability	Up to 10 units			
Current Sharing ^[7]	12V	12V	20V	30V
Efficiency (full load)	91%	91%	91%	92%
Other				
Protection Function	OVP/OCP/OTP/OPP/SCP/FOLDBACK			
Anti Reverse Irrigation Protection	No(customers can purchase other accessories to achieve this function, please consult the salesrepresentative for details)	Yes	Yes	Yes
Input Fuse	40A, 125VAC/250VAC, fast-acting type			
Unit Weight/Shipping Weight	14.7kg/18.7kg	14.7kg/18.7kg	13.2kg/16.8kg	13.2kg/16.8kg
Dimensions(WxHxD)	423.0x87.0x514.0 mm	423.0x87.0x514.0 mm	423.0x87.0x469.0 mm	423.0x87.0x469.0 mm
Communication Modes	1. RS232/RS485/USB/LAN; 2. RS232/RS485/USB/LAN/GPIB			
Operating Environment	Temperature 0~40°C, Relative Humidity 10%~90%(no condensation); Pollution degree 2, Installation category II, Indoor use.			
Cooling Mode	Forced air-cooling			
Altitude	2000m			
Insulation	AC input <->DC output, 4242VDC, AC input <-> PE, 2121VDC			

● 4000W in 2U(2)

Model	SP150VDC4000W	SP200VDC4000W	SP600VDC4000W	SP800VDC4000W
Input				
Input Voltage	190~265VAC			
Input Frequency	47~63Hz			
Power Factor	>0.98			
Input Power	4500VA(MAX)			
Output				
Output Voltage Range	0~150V	0~200V	0~600V	0~800V
Output Current Range	0~30A	0~24A	0~10A	0~7.5A
Output Power Range	0~4000W			
Voltage Load Regulation	15mV	25mV	30mV	200mV
Current Load Regulation	30mA	24mA	10mA	20mA
Voltage Display Resolution	1mV			
Current Display Resolution	0.1mA			
Voltage Programmable Resolution	3mV	4mV	12mV	24mV
Current Programmable Resolution	1mA			
Voltage Setting Accuracy ^[1]	0.1%+15mV	0.1%+15mV	0.05%+150mV	0.05%+200mV
Current Setting Accuracy	0.1%+30mA	0.1%+24mA	0.1%+10mA	0.1%+7.5mA
Voltage Measurement Accuracy ^[2]	0.1%+15mV	0.1%+15mV	0.05%+150mV	0.05%+200mV
Current Measurement Accuracy	0.1%+30mA	0.1%+24mA	0.1%+10mA	0.1%+7.5mA
Voltage Ripple ^[3]	80mVp-p 15mVrms	150mVp-p 30mVrms	350mVp-p 40mVrms	800mVp-p 200mVrms
Current Ripple ^[3]	60mA (Full Range) 10mA (TYP Value)	50mA (Full Range) 20mA (TYP Value)	25mA (Full Range) 10mA (TYP Value)	25mA (Full Range) 10mA (TYP Value)
Line Regulation(Voltage)	0.02%+8mV	0.02%+8mV	0.01%+30mV	0.01%+40mV
Line Regulation(Current)	30mA	30mA	15mA	20mA
Voltage Temperature Coefficient ^[6]	100ppm/°C			
Current Temperature Coefficient ^[6]	150ppm/°C			
DVM Resolution	1mV	1mV	12mV	12mV
DVM Precision ^[1]	0.1%+15mV	0.1%+15mV	0.05%+150mV	0.05%+200mV
Operating Mode	Constant voltage (CV) / Constant current (CC)			
Remote Compensation	5V MAX			
Master-slave Control	Yes			
Response (Voltage Increase)	≤25ms	≤30ms	≤60ms	≤60ms
Response (Voltage Drop)	≤500ms (no load) ≤25ms (full load)	≤500ms (no load) ≤20ms (full load)	≤800ms (no load) ≤60ms (full load)	≤800ms (no load) ≤60ms (full load)
Load Transient Recovery Time ^[8]	≤2.5ms	≤3ms	≤3ms	≤3ms
Command Response Time	50ms			
Series Capability ^[8]	Up to 8 units	Up to 6 units	Up to 2 units	Not Recommended
Parallel Capability	Up to 10 units			
Current Sharing ^[7]	40V	50V	200V	250V
Efficiency (full load)	93%	92%	92%	92%
Other				
Protection Function	OVP/OCV/OTP/OPP/SCP/FOLDBACK			
Anti Reverse Irrigation Protection	Yes			
Input Fuse	40A, 125VAC/250VAC, fast-acting type			
Unit Weight/Shipping Weight	13.2kg/16.8kg	13.2kg/16.8kg	14.7kg/18.7kg	14.7kg/18.7kg
Dimensions(WxHxD)	423.0x87.0x469.0 mm	423.0x87.0x469.0 mm	423.0x87.0x514.0 mm	423.0x87.0x514.0 mm
Communication Modes	1. RS232/RS485/USB/LAN; 2. RS232/RS485/USB/LAN/GPIB			
Operating Environment	Temperature 0~40°C, Relative Humidity 10%~90%(no condensation); Pollution degree 2, Installation category II, Indoor use.			
Cooling Mode	Forced air-cooling			
Altitude	2000m			
Insulation	AC input <->DC output, 4242VDC, AC input <-> PE, 2121VDC			

Remark

- [1] %output+offset, when output voltage less than 5V, offset voltage is 30mV.
- [2] Vp-p@20MHz, Vrms@1.25MHz.
The 20V/32V/40V/75V models voltage ripple is 50mVp-p/6mVrms @ 1V.
For the 600V and 800V models, the voltage ripple from 0~5V is out of the range show above.
- [3] Arms@1.25MHz, the TYP Value is measured at the rated output voltage with 100% resistive load, and the measured value at full range of output voltage with 100% resistive load is less than the Full Range value.
- [4] 0~40°C.
- [5] Time for output voltage to recover within 0.5%(0.75% @800V models) of its rated output for a load change from 10% to 90% of its rated output current. Voltage set point from 10% to 90% of rated output.
- [6] The communication must insulated users from output when using remote control and the output voltage exceeds 800VDC.
- [7] Current Share error $I_e < (I_{av} * 2.5\% + 5\% \text{ F.S}) \text{ A}$, F.S is the full scale of the current. $I_{av} = I_{sum} / n$, where I_{av} is average current, I_{sum} is total current and n is number of parallel units. Output voltage must be higher than 30% of maximum output voltage when Current Share function properly.

All specifications are subject to change without notice.

Appendix B Web Server

1. Connection Mode

This series power supplies including Web Server, offer both local operation and remote operation.

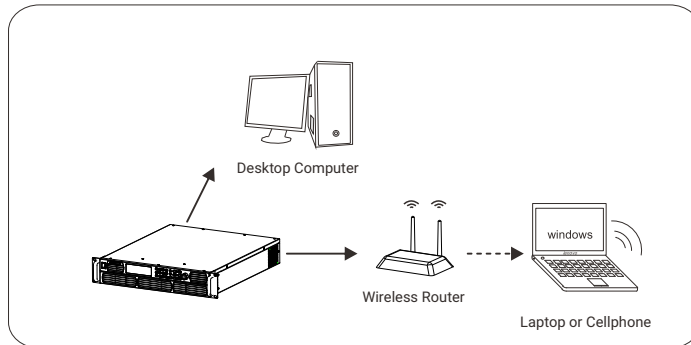

The connection above is for local operation, the IP address of the power supply and computer must be set in the same segment. It is possible to control the power supply from a laptop or a cellphone using the wireless router.

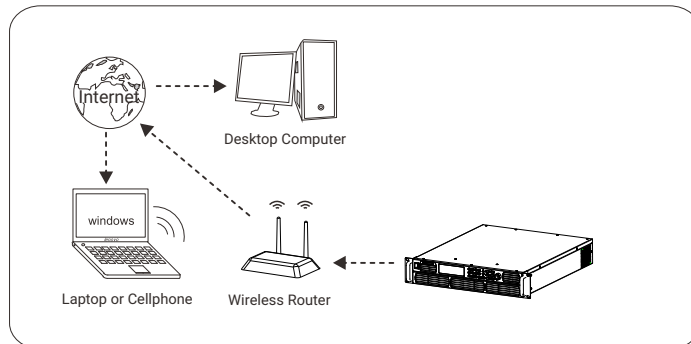

The connection above is for remote operation, the wireless router is connected to the internet.

2. WebServer

2.1 Login Menu

On the computer, open up the web browser, copy down the IP ADDR that you assigned and type that address in the URL bar of your browser. If correctly configured, the following screen will be shown:

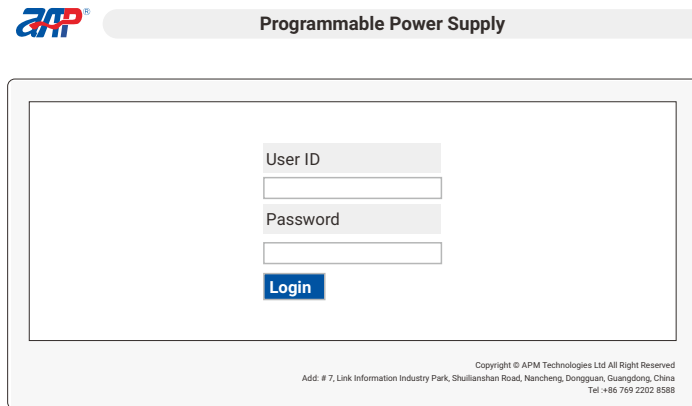

A password is required to login and access any of the menu items on the page. The User ID is “Admin”, and the default admin password is “123456”.

2.2 Home Menu

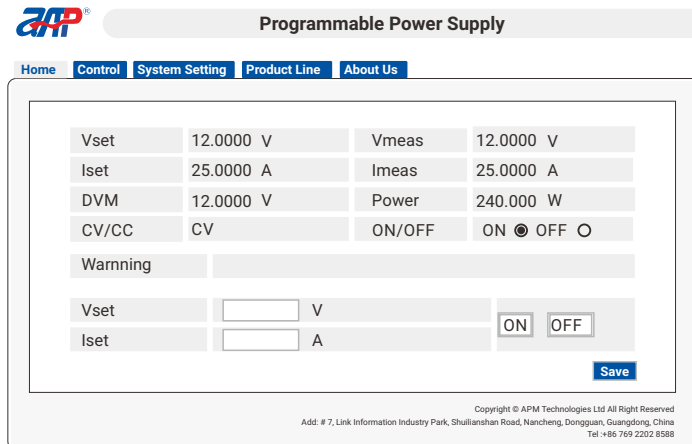

Home menu allows the user to set up the voltage, current, and output state of the power supply. The voltage measured value, current measured value and operating mode of the power supply will be shown on the page as well.

2.3 Control Menu

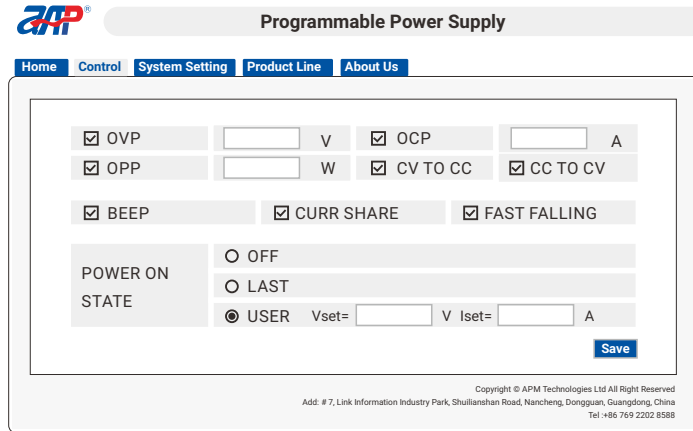

The screenshot shows the 'Control' menu of a Programmable Power Supply. It features a navigation bar with 'Home', 'Control', 'System Setting', 'Product Line', and 'About Us'. The main content area contains several configuration options:

- OVP [] V OCP [] A
- OPP [] W CV TO CC CC TO CV
- BEEP CURR SHARE FAST FALLING
- POWER ON STATE:
 - OFF
 - LAST
 - USER Vset= [] V Iset= [] A

A 'Save' button is located at the bottom right of the configuration area. At the bottom of the page, there is a copyright notice: 'Copyright © APM Technologies Ltd All Right Reserved. Add: # 7, Link Information Industry Park, Shullianshan Road, Nancheng, Dongguan, Guangdong, China. Tel: +86 769 2202 8588'.

Control menu allows the user to configure the following parameters: OVP setting, OCP setting, OPP setting, CV TO CC protection, CC TO CV protection, BEEP setting, CURR SHARE setting, FAST FALLING setting and POWER ON STATE setting.

2.4 System Setting Menu

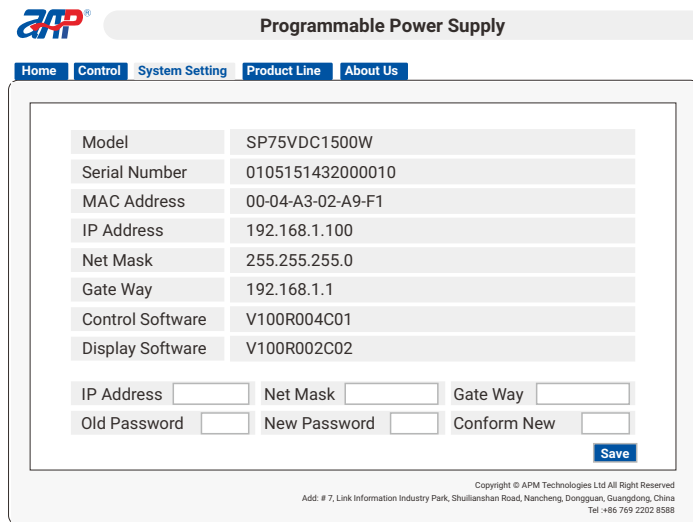

The screenshot shows the 'System Setting' menu of a Programmable Power Supply. It features a navigation bar with 'Home', 'Control', 'System Setting', 'Product Line', and 'About Us'. The main content area displays system information and configuration options:

Model	SP75VDC1500W	
Serial Number	0105151432000010	
MAC Address	00-04-A3-02-A9-F1	
IP Address	192.168.1.100	
Net Mask	255.255.255.0	
Gate Way	192.168.1.1	
Control Software	V100R004C01	
Display Software	V100R002C02	

Below the table, there are input fields for:

- IP Address [] Net Mask [] Gate Way []
- Old Password [] New Password [] Conform New []

A 'Save' button is located at the bottom right of the configuration area. At the bottom of the page, there is a copyright notice: 'Copyright © APM Technologies Ltd All Right Reserved. Add: # 7, Link Information Industry Park, Shullianshan Road, Nancheng, Dongguan, Guangdong, China. Tel: +86 769 2202 8588'.

System Setting menu shows the information of the power supply. The user can change LAN communication parameter and the password on this page.

2.5 Product Line Menu

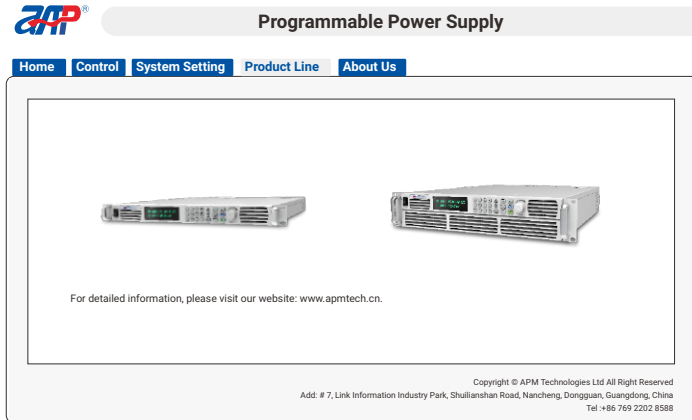

Product Line menu shows the PPS product line of APM.

2.6 About Us Menu

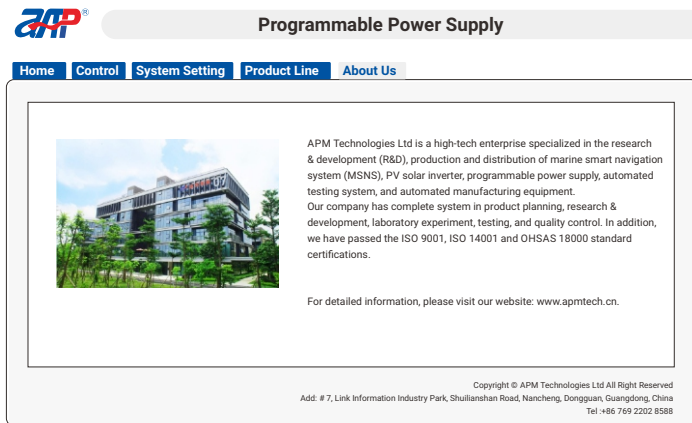

About Us menu provides the profile of APM.

Appendix C Warranty

Thank you for purchasing the SP-1U/2U Series High Performance Programmable DC Power Supply of APM Technologies (referred to hereafter as “APM”). In order for you to use our products properly, APM provides you with the standard warranty service as stipulated below. Please read the following instructions carefully.

This warranty card is applicable to the SP-1U/2U Series Programmable DC Power Supply of APM.

All quality warranties and services offered by your distributors are not subject to or covered by this warranty card. Our company bears no responsibility for honoring any commitment or warranty in the aspect for quality warranty or services made by the distributors.

Warranty Period

1. The warranty period of APM SP-1U/2U Series Programmable DC Power Supply is 2 (two) years, or refer to relevant Distributor Agreement terms.
2. The warranty period will not be extended or recalculated after a product or component replacement; repaired or replaced products are covered for the remainder of the original warranty period and subject to the conditions outlined in the original warranty.

Warranty Terms

1. In case of product malfunction within the warranty period, please send both the scanned copy of warranty card and purchasing invoice to the APM Customer Service by email. APM will provide you services for maintenance and replacement of defected product or components according to the actual conditions. Whatever method we may adopt, APM always strives to provide you with the highest standard and utmost professional after-sales services.
2. In case of product replacement, all replaced or exchanged parts which are removed under this warranty will become the property of APM. Please return the replaced product and components to the original place of purchase for APM to collect the replaced items in a certain period of time.

Liability Waiver

APM reserves the rights to refuse product warranty service under the following circumstances:

1. The product is out of warranty period.
2. Inability to provide the purchasing invoice issued either by the product distributor or the installer besides of unable to determine the product manufacturer as APM.
3. APM logo or product label is missing or not readable.
4. Product is without an anti-dismantle label or the anti-dismantle label is damaged.
5. Accessories included with each product are not in the product warranty scope
6. Defects or damages caused by or resulting from inadequate or improper repairs carried out by any person, entity or service facility which is not authorized by APM to perform warranty services on its behalf.

7. Defects or damages caused by or resulting from failure to comply with the operating instructions and contents specified in the related product manuals.
8. Defects or damages due to operation in very harsh environment that is beyond the limitations specified in this product manual.
9. Defects or damages due to the use of non-standard parts or software or parts which are not developed or manufactured by APM.
10. Defects or damages caused by or resulting from force majeure (including but not limited to lightning, immersion in liquid, etc.).
11. Defects or damages caused by or resulting from accidents or negligent use (including but not limited to transportation, storage, connection to incompatible voltage, improper operation, etc.).
12. Cosmetics defects or damages which won't affect normal operation of the product.

For the malfunction caused by above-mentioned circumstances, APM or its authorized service facility based on its own judgment is willing to provide a paid service in respond to our customer's request.

Disclaimer

1. APM will bear no responsibility for the compensation of direct or consequential functional malfunction caused by or resulting from product failure. APM will not be responsible for the data loss caused by or resulting from improper operation or due to non-product quality problem. The user should appropriately back up the data by themselves. Nor will APM be responsible for the personal injury or property losses caused by or resulting from non-product quality problem. If in any situation APM puts forward or expresses the warranty commitments conflicting with the above clauses, it should be subject to the later one.
2. In order to uphold your warranty rights, please call or mail APM Customer Service to register your product and to put warranty coverage in force.
3. Only APM has the rights to revise the conditions of the warranty given; any trader, distributor or installer has no rights to make any modification to the warranty provided by APM, or represent APM to express any opinion and behavior; APM reserves the final interpretation rights.
4. Should any malfunction of product occurs, please contact your installer, distributor or dealer timely so as for us to provide you with corresponding and appropriate services.
5. If technicians of APM provide you an on-site service, please show the warranty card which should be filled out by the visiting technicians.

Remark

1. Please retain the schedule and your purchase invoice as the proofs for warranty.
2. Please show the schedule each time prior to beginning of work for the maintenance personnel to fill out.
3. The schedule should be properly kept within product warranty period as APM won't issue any replacement schedule after the loss of the original one.

Schedule

Product Information		
Distributor	Company Name	
	Contact Person	
	Phone Code	
	Address	
User's Information		
User	Name	
	Phone Code	
	Address	
	Fax	
	E-mail	
Product Malfunction Information		
Model		
Serial No.		
Warranty Period		
Date of Malfunction	Signature	Malfunction Description & Solutions

Please stick the product
Serial number here.



Appendix D Anti reverse irrigation/Power Sink

This series power supply has protection against reverse irrigation, so as to cut off the current of DUT in a certain test condition to the direction of power supply, and prevent the damage to the power supply hardware circuit from DUT.

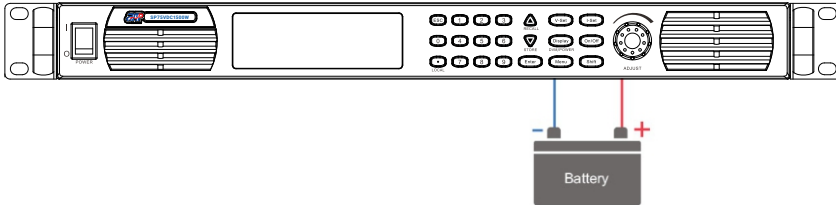

Meanwhile, this series power supply comes standard with short circuit copper sheet, when the test requires the power supply to absorb the spike generated by DUT to ensure the safety of the operation, the short-circuit copper piece can be connected, and the energy is absorbed by the output capacitor inside the power supply and other circuits.

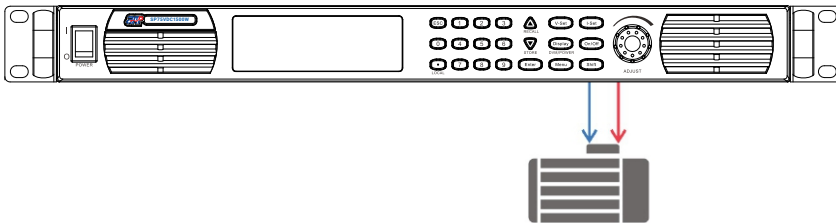

Note

- Please consult your sales representative to get detailed information about anti reverse irrigation protection for power supply models above 200A.

Connection method with anti-reverse irrigation function (as below A).

How to connect the copper sheet when connecting the motor or similar device (as below B).

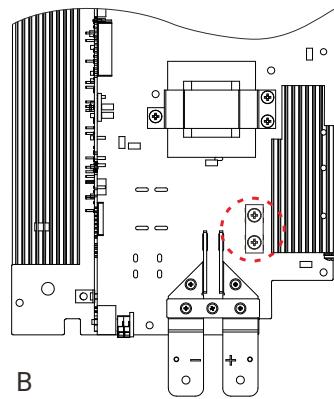
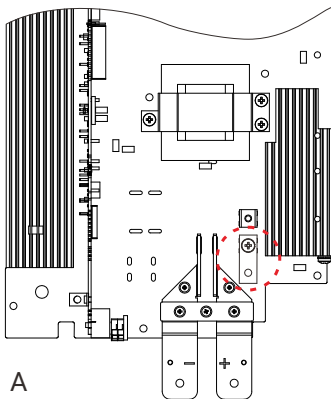



Add: # 7, Link Information Industry Park, Shuilianshan
Road, Nancheng, Dongguan, Guangdong, China

Tel: +86 769 2202 8588 E-mail: MK@apmtech.cn
Fax: +86 769 2202 6771 Web: en.apmtech.cn