

# GPP-3060/6030

## Triple-Channel Programmable DC Power Supply

### FEATURES

- 4.3" TFT LCD Display
- Setting Resolution: 1mV / 0.1mA; Read Back Resolution: 0.1mV/0.1mA
- Low Ripple Noise:  $\leq 1\text{mVrms}/\leq 2\text{mArms}$
- Transient Response Time:  $\leq 100\mu\text{S}$
- Load Function (CC, CV, CR mode)
- Tracking Series and Parallel Function without Additional External Wiring
- Utilizing Hardware to Realize Over Voltage Protection/ Over Current Protection/Over Temperature Protection
- Delay Function/Output Monitoring Function/Output Recorder Function
- Supports Setting Value, Measurement Value and Output Waveform Display
- Sequential Output Function and Built-in 8 Template Waveforms
- The Output Recorder Function Records the Output Voltage & Current Parameters with a Minimum Recording Interval of 1 Second
- Provides 10 Sets of Memory for Each Sequence/Delay/Recorder/ Panel Setting Condition
- GPP-3060/6030 Supports a USB (Type A) Output Terminal
- Intelligent Temperature Control Fan Effectively Reduces Noise
- Standard: RS-232, USB, LAN, Ext I/O  
Optional (manufacturer installed only): GPIB

# Meet Your Necessity of High Resolution in Multi-Channel Measurement

GPP-3060 and GPP-6030 triple-channel programmable DC power supplies are extension models of the GPP-X323 series. The maximum output power of these two models is 385W. GPP-3060 supports CH1/CH2: 0 ~ 30V / 0 ~ 6A output; GPP-6030 supports CH1/CH2: 0 ~ 60V / 0 ~ 3A output; CH3 of both models supports 1.8V, 2.5V, 3.3V, 5.0V/5A.

GPP-3060 and GPP-6030 inherit the high program resolution (1mV/0.1mA) and read back resolution (0.1mV/0.1mA) of the GPP series with low-ripple noise characteristics  $\leq 1\text{mVrms}/\leq 2\text{mArms}$  and  $\leq 100\mu\text{s}$  output transient recovery ability. An independent output on-off switch is provided for each channel.

For series and parallel applications of CH1 and CH2, the tracking function can automatically switch to series or parallel output without additional external wiring. Multiple display modes including single channel or multi-channel setting value, measurement value and waveform display to collocate with the built-in output monitoring function allow users to set the monitoring conditions according to their needs so as to generate an alarm or stop the output during the measurement process in order to stop the measurement and protect the customer's DUT. The output recorder function can record the voltage/current of the output process in the internal memory, and save the result as a (\*.REC) or (\*.CSV) file, and then save it to a USB flash drive. The unique load function of the GPP series can arbitrarily set CH1/CH2 as power supply or load function. For example, one channel is set as power output, and the other channel is set as load function to consume the power of the DUT to satisfy simple battery charging and discharging or load characteristic test by a single power supply. The sequence output function allows users to edit the power output waveforms by themselves, and also allows users to set the sequential constant voltage (CV) or constant current (CC) load waveforms such as serial power output or dynamic load simulation test. Channel 3 (CH3) incorporates 3A USB (Type A) output terminal, which can be used for USB charging test.

Pertaining to measurement protections, OVP/OCP/OPP/OTP protection functions are provided. The protection mechanism of OVP/OCP/OTP is implemented by hardware circuits, which has a faster response time to protect equipment or DUT while comparing with competitors who use software for protection. The OVP and OCP functions allow users to set the protection action point according to the conditions of the DUT. OPP only provides protection during the operation of the load function.

In addition, GPP-3060 and GPP-6030 incorporate terminal output on the rear panel, and include a voltage remote sensing terminal. Users can choose front panel or rear panel terminal output, which is convenient for stand-alone or rack operation. Output value setting and Sequence/ The Delay/Recorder functions provide 10 sets of internal memory, which can be uploaded/stored by a USB flash drive.



**GPP-6030**



**GPP-3060**



## A. TRACKING SERIES AND PARALLEL FUNCTION

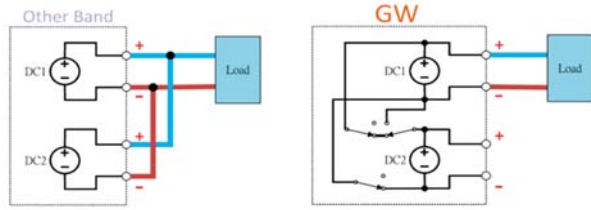

Output in Parallel Connections

For series and parallel applications of CH1 and CH2, the tracking function of the GPP-Series utilizes the internal circuit to automatically switch the output to serial or parallel output without additional external wiring, providing users with convenience not only in operating procedures but also a more stable output.

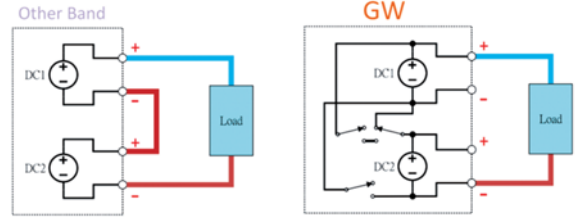

Output in Series Connections

The tracking function design of other brands requires additional external wiring connections for the output in series or parallel. However, excessively long, thin or inconsistent external wiring may cause inaccurate voltage or current output.

## B. OUTPUT MONITORING FUNCTION

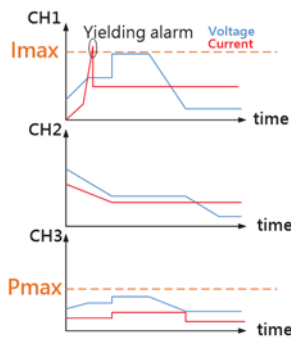

Output Monitoring

The output monitoring function allows users to set the monitoring conditions according to the requirements, including the voltage, current, and power greater than or less than the setting and the logical relationship of AND, OR. It also allows users to sound



Monitoring Function Setting

alarms or stop the output during the measurement process, stop the measurement, and protect the customer's DUT. Each Channel could be monitored simultaneously as well.

\* Channel 3 does not support the output monitoring function.

## C. SEQUENCE OUTPUT FUNCTION

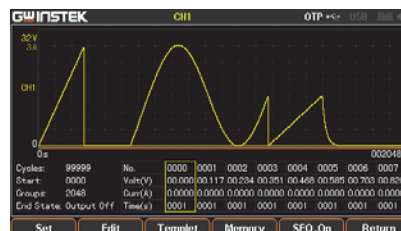

Output Waveform of the GPP-6030/3060

The GPP-Series provides a sequential output function on Channel 1 and Channel 2. This function not only allows users to edit the power output waveform, but also allows users to set the sequential constant voltage (CV) or constant current (CC) load waveform, i.e. a serial power output or a simulation test of a dynamic load. The maximum settable points for sequence function are 2048, and interval range of each point can be set from 1 to 300 seconds. In order to simplify the setting of waveform editing, the GPP-Series has 8 built-in Templet waveforms in sequence output function for

users to directly apply for output, including Sine, Pulse, Ramp, Stair Up, Stair Dn, Stair UpDn, Exp Rise, and Exp Fall waveforms.

The editing data of the sequence output can be stored in the internal 10 sets of the memory, or to be saved by USB flash drive (Save/Recall) and saved as \*.SEQ or \*.CSV file; The stored \*.SEQ can be exported into Excel for editing and analysis. The final edited file can be imported to (Save/Recall) of the power supply using a USB flash drive.

## D. HARDWARE PROTECTION FUNCTION(OVP/OCP/OTP)

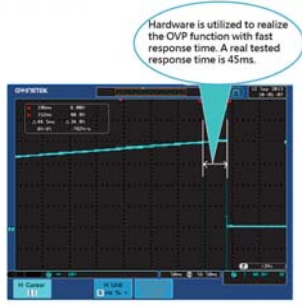

OVP Trigger

The protection mechanism of OVP/OCP/OTP is implemented by hardware circuit, which has the advantage of faster response time than competitors who use software to achieve protection. When it is detected that the voltage of the DUT exceeds the setting value of the OVP, the output of the power supply can be stopped in a short time to achieve the purpose of protecting the DUT.

## E. LOAD FUNCTION

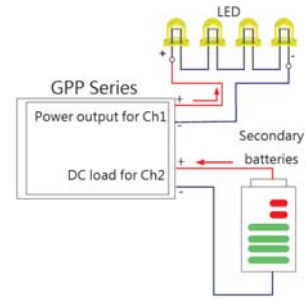

GPP-Series Application

The CH1/CH2 of the GPP series is designed with the load function. A single power supply can meet the basic battery charging and discharging test requirements. It can provide power output in channel 1 and channel 2. The rated constant voltage load (CV), rated constant current load (CC) and maximum 1kΩ constant resistance load (CR) function are built-in to allow users to conduct discharging test without using an electronic load. In application, users can also set either that one channel of the single GPP series as the power output, one channel as the load function to consume the power of the DUT, or that both channels as load functions to consume the power of different loads simultaneously.

## F. OUTPUT DELAY FUNCTION

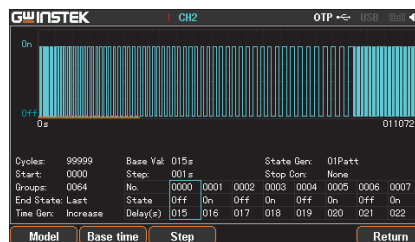

GPP-Series Delayed Waveform

Output delay function allows users to edit the timing waveform of the power output on/off when the front panel voltage and current settings are unchanged. In order to simplify the setting of waveform editing, the GPP-Series has three built-in timing modes in the delay output function, including Fixtime, Increase, Decline for users to apply directly. The editing data of the output delay can be stored in

the internal 10 sets of memory, or to be saved by USB flash drive (Save/Recall) and saved as \*.DLY or \*.CSV file. The stored \*.CSV can be exported into Excel for editing and analysis. The final edited file can be exported to (Save/Recall) of the power supply using a USB flash drive.

## G. OUTPUT RECORDER FUNCTION

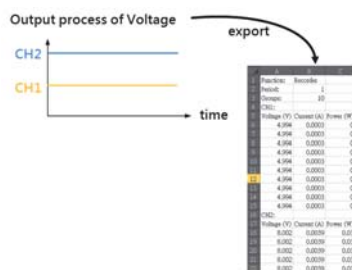

Schematic Diagram for Recorder Function

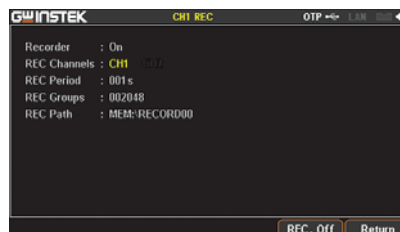

Recorder Function Setting



Save as \*.REC

The output recorder function records the voltage & current parameters of the output process. The recording interval of each point can be set according to user's requirements, and the shortest interval is 1 second and the longest is 300 seconds. The results can be stored in \*.REC or \*.CSV format to the power supply or directly

saved in the USB flash drive. The stored \*.CSV can be exported into Excel to conduct the future analysis. (\*.REC can be saved to 2018 records, \*.CSV can be saved to 614400 records)

\* Channel 3 does not support the output recorder function

## PANEL INTRODUCTION



1. LCD Display
2. Number Pad
3. Function Keys
4. Output Buttons
5. USB Host
6. Front Panel Output Terminals
7. Power Button
8. Power Output Terminal(CH3, USB type)
9. AC Selector Switch
10. AC Input Socket and Line Fuse
11. RS-232 Port
12. USB Device Port
13. Ext I/O Port
14. GPIB Port
15. LAN Port
16. Rear Output Terminals

GRA-437-J Rack Mount Kit (JIS)



GRA-437-E Rack Mount Kit (EIA)



## OPERATING RANGE

Model Number	Number of Output	Max. Power	CH1	CH2	CH3	Interface
GPP-3060	3	385W	0-30V/0-6A	0-30V/0-6A	1.8V/2.5V/3.3V/5V; 5A	USB, RS-232, LAN, GPIB
GPP-6030	3	385W	0-60V/0-3A	0-60V/0-3A	1.8V/2.5V/3.3V/5V; 5A	USB, RS-232, LAN, GPIB

\* GPIB interfaces cannot be retrofitted after the shipment. When ordering the model, please confirm whether to order GPIB. \* Model ordering varies by region.

## OUTPUT FUNCTION LIST

Model Number	GPP-3060/GPP-6030		
	CH1	CH2	CH3
Functions	CH1	CH2	CH3
Sequence Output Function	✓	✓	—
Load Functions (CC, CV, CR mode)	✓	✓	—
Output Delay Function	✓	✓	—
Output Monitoring Function (10 sets)	✓	✓	—
Output Recorder Function	✓	✓	—
Panel Save/Recall	✓	✓	✓

## SPECIFICATIONS

		GPP-3060			GPP-6030		
OUTPUT MODE	Number of Channel Voltage Current	CH1	CH2	CH3	CH1	CH2	CH3
		0~30V	0~30V	1.8/2.5/3.3/5V, ±5%	0~60V	0~60V	1.8/2.5/3.3/5V, ±5%
		0~6A	0~6A	5A(MAX), 3A(MAX,USB port)	0~3A	0~3A	5A(MAX), 3A(MAX,USB port)
	Tracking Series Voltage	0~60V		—	0~120V		—
	Tracking Parallel Current	0~12A		—	0~6A		—
CONSTANT VOLTAGE OPERATION	Line Regulation	≤0.01%+3mV		≤3mV	≤0.01%+3mV		≤3mV
	Load Regulation	≤0.01%+5mV (rating current ≤10A)		≤5mV	≤0.01%+5mV (rating current ≤10A)		≤5mV
	Ripple & Noise(5Hz~1MHz)	≤1mVrms		≤2mVrms	≤1mVrms		≤2mVrms
	Recovery Time	≤100μs		≤100μs	≤100μs		≤100μs
CONSTANT CURRENT OPERATION	Line Regulation	≤0.01%+3mA		—	≤0.01%+3mA		—
	Load Regulation	≤0.01%+3mA		—	≤0.01%+3mA		—
	Ripple & Noise	≤2mA		—	≤2mA		—
TRACKING OPERATION (CH1,CH2)	Tracking Error	≤0.1%+10mV of Master(GPP-3060), ≤0.2%+20mV of Master(GPP-6030) (No Load, with load add load regulation ≤200mV)					
	Parallel Regulation	Line: ≤0.01%+3mV Load: ≤0.01%+5mV(rating current ≤10A); ≤0.02%+5mV(rating current >10A)					
	Series Regulation	Line: ≤0.01%+5mV; Load: ≤200mV					
	Ripple & Noise(5Hz~1MHz)	≤2mVrms(5Hz ~ 1MHz)					
METER	Voltage Programming Resolution	1mV		—	2mV		—
	Current Programming Resolution	0.2mA		—	0.1mA		—
	Voltage Readback Resolution	0.1mV		—	0.1mV		—
	Current Readback Resolution	0.1mA		—	0.1mA		—
	Voltage Setting Accuracy	≤±(0.03% of reading+10mV)		—	≤±(0.03% of reading+10mV)		—
	Current Setting Accuracy	≤±(0.30% of reading+10mA)		—	≤±(0.30% of reading+10mA)		—
	Voltage Readback Accuracy	≤±(0.03% of reading+10mV)		—	≤±(0.03% of reading+10mV)		—
	Current Readback Accuracy	≤±(0.30% of reading+10mA)		—	≤±(0.30% of reading+10mA)		—
DC LOAD CHARACTERISTIC	Channel	CH1/CH2		—	CH1/CH2		—
	Display Power	0~50.00W		—	0~50.00W		—
	Display Voltage	1~32.00V		—	1~62.00V		—
	Display Current	0~6.200A		—	0~3.200A		—
	CV Mode Setting Range	1.500V~32.00V		—	1.500V~62.00V		—
	Resolution	10mV		—	10mV		—
	Set Accuracy	≤0.1%+30mV		—	≤0.1%+30mV		—
	Read Accuracy	≤0.1%+30mV		—	≤0.1%+30mV		—
	CC Mode Setting Range	0~6.200A		—	0~3.200A		—
	Resolution	1mA		—	1mA		—
	Set Accuracy	≤0.3%+10mA		—	≤0.3%+10mA		—
	Read Accuracy	≤0.3%+10mA		—	≤0.3%+10mA		—
CR Mode Setting Range	1~1kΩ		—	1~1kΩ		—	
Resolution	1Ω		—	1Ω		—	
Set Accuracy	≤3%+1Ω(Voltage ≥0.1V, Current ≥0.1A)		—	≤3%+1Ω(Voltage ≥0.1V, Current ≥0.1A)		—	
Read Accuracy	≤3%+1Ω(Voltage ≥0.1V, Current ≥0.1A)		—	≤3%+1Ω(Voltage ≥0.1V, Current ≥0.1A)		—	
INSULATION	Chassis and Terminal	20MΩ or above (DC 500V)					
	Chassis and AC Power Cord	30MΩ or above (DC 500V)					
ENVIRONMENT CONDITION	Operation Temp	0~40°C					
	Storage Temp	-10~70°C					
	Operating Humidity	≤80% RH					
	Storage Humidity	≤70% RH					
INTERFACE	Standard: RS-232, USB, LAN, Ext I/O; Optional(manufacturer installed only): GPIB						
POWER SOURCE	AC100V/120V/220V/230V±10%, 50/60Hz						
POWER CONSUMPTION	900VA, 680W						
DIMENSION & WEIGHT	213(W) x 145(H) x 362(D) mm; Approx. 10kg						

Specifications subject to change without notice.

GPP-30606030GDI1BH\_202109

### ORDERING INFORMATION

**GPP-3060** 385W Triple-channel Programmable DC Power Supply  
**GPP-6030** 385W Triple-channel Programmable DC Power Supply

### ACCESSORIES

CD (User manual), Quick start manual, Power cord, Test lead :  
 GTL-104A x 3, European test leads: GTL-204A x 3, GTL-201A x 1

### OPTIONAL ACCESSORIES

**GTL-246** USB Cable  
**GRA-437-E** Rack Mount Kit (EIA)  
**GRA-437-J** Rack Mount Kit (JIS)

### INTERFACE

Standard: RS-232, USB, LAN, Ext I/O  
 Optional(manufacturer installed only): GPIB

NOTE: Contact local sales if you have issues with Interface purchase.

Combined Test Solutions,  
4 Commerce Way, Stanbridge Road,  
Leighton Buzzard, LU7 4RW

T: 01525 374466  
E: [sales@ctstest.co.uk](mailto:sales@ctstest.co.uk)  
W: [www.ctstest.co.uk](http://www.ctstest.co.uk)

