



Programmable DC Power Supply

GPP-3060/GPP-6030

User Manual



ISO-9001 CERTIFIED MANUFACTURER

Copyright Statement

This manual contains proprietary information, which is protected by copyright. All rights are reserved. No part of this manual may be photocopied, reproduced or translated to another language without prior written consent of Combined Test Solutions.

The information in this manual was correct at the time of printing. However, Combined Test Solutions continues to improve products and reserves the rights to change specification, equipment, and maintenance procedures at any time without notice.

Table of Contents

SAFETY INSTRUCTIONS	7
Safety Symbols	7
Safety Guidelines	8
Power cord for the United Kingdom	11
OVERVIEW	12
Introduction	13
Key Features	16
Front Panel	18
Rear Panel	24
Constant Voltage/Constant Current Crossover Characteristics	26
GETTING STARTED	27
Start Up	28
Load Connection	29
Select front/rear panel output	31
Turning the Output On/Off	32
BASIC OPERATION	33
Display Change	34
Source Function	37
Independent Output Mode	43
Tracking Series and Tracking Parallel Modes	45
Load Function	50
Sequence Function	54
Set Sequence Output	54
Set Group Parameter	57
Construct Templet	58
Menu Tree	61

Save and Recall	63
Delay Function	66
Set Delay Output	66
Set Group Parameter	69
Menu Tree.....	72
Save and Recall.....	74
Monitor Function	77
Set Monitor.....	77
Recorder Function.....	81
Set Recorder.....	81
External I/O Control.....	85
Key Function Description	87
FILE OPERATION.....	89
Save/Recall	90
Restore Factory Default Settings	93
SYSTEM SETTINGS.....	94
System Information	95
System Settings	96
Firmware Upgrading	98
Description of Using Flash Drive	99
REMOTE CONTROL.....	101
Connection Usage.....	103
RS-232	104
USB	106
GPIB.....	108
LAN	110
Command Syntax	116
Command List	120
Measurement Instructions.....	120

Display Functions 120

Output Commands 120

Source and Load Commands 121

Status Commands 126

System Commands 127

System Related Commands 128

IEEE488.2 Common Commands 129

Command Details 130

 Measurement Commands 130

 Display Commands 132

 Output Commands 134

 Source and Load Commands 139

 Status Commands 183

 System Commands 190

 System Related Commands 199

SCPI Status Registers SCPI 200

 Event Registers 202

 Enable Registers 202

 Status Byte Register 202

 Standard Event Register 204

 Status Byte Register Commands 205

 Standard Event Register Commands 206

 Other Status Register Commands 208

Errors 209

 Error Message 209

 Command Errors 209

APPENDIX 213

 Replacing the Fuse 213

 Specifications 214

 Optional Accessories 217







Declaration of Conformity..... 218

S SAFETY INSTRUCTIONS

This chapter contains important safety instructions that you must follow during operation and storage. Read the following before any operation to insure your safety and to keep the instrument in the best possible condition.

Safety Symbols

These symbols may appear in the manual or on the instrument.

 WARNING	Warning: Identifies conditions or practices that could result in injury or loss of life.
 CAUTION	Caution: Identifies conditions or practices that could result in damage to the GPP or to other properties.
 DANGER High Voltage	
 Attention Refer to the Manual	
 Protective Conductor Terminal	
 Earth (ground) Terminal	
	Do not dispose electronic equipment as unsorted municipal waste. Please use a separate collection facility or contact the supplier from which this instrument was purchased.

Safety Guidelines

General
Guideline



CAUTION

- Do not place any heavy object on the unit.
 - Avoid severe impact or rough handling that leads to damaging the unit.
 - Do not discharge static electricity to the unit.
 - Do not block the cooling fan opening.
 - Do not perform measurements on circuits that are directly connected to mains power.
 - Do not disassemble the GPP unless you are qualified.
 - (Measurement categories) EN 61010-1:2010 specifies the measurement categories and their requirements as follows. The GPP Series falls under category I .
 - Measurement category IV is for measurement performed at the source of low-voltage installation .
 - Measurement category III is for measurement performed in the building installation.
 - Measurement category II is for measurement performed on the circuits directly connected to the low voltage installation.
 - Measurement category I is for measurements performed on circuits not directly connected to Mains.
-

- (Pollution Degree) EN 61010-1:2010 specifies pollution degrees and their requirements as follows. Pollution refers to “addition of foreign matter, solid, liquid, or gaseous (ionized gases), that may produce a reduction of dielectric strength or surface resistivity”. The GPP Series falls under degree 2.
 - Pollution degree 1: No pollution or only dry, non-conductive pollution occurs. The pollution has no influence.
 - Pollution degree 2: Normally only non-conductive pollution occurs. Occasionally, however, a temporary conductivity caused by condensation must be expected.
 - Pollution degree 3: Conductive pollution occurs, or dry, non-conductive pollution occurs which becomes conductive due to condensation which is expected. In such conditions, equipment is normally protected against exposure to direct sunlight, precipitation, and full wind pressure, but neither temperature nor humidity is controlled.
-

Power Supply



WARNING

- AC Input voltage range:
100V/120V/220V/230V $\pm 10\%$
 - Frequency: 50Hz/60Hz
 - To avoid electrical shock connect the protective grounding conductor of the AC power cord to an earth ground.
-

Fuse



WARNING

- Fuse type: 100V/120V: T12A/250V,
220V/230V: T5A/250V
 - To prevent fire, replace the fuse only with the specified type and rating.
 - Disconnect the power cord before replacing the fuse.
 - Make sure the cause of fuse blowout is fixed before replacing the fuse.
-

Cleaning the power supply	<ul style="list-style-type: none">• Disconnect the power cord before cleaning it .• Use a soft cloth dampened in a solution of mild detergent and water. Do not spray any liquid into it.• Do not use chemicals containing harsh products such as benzene, toluene, xylene, and acetone.
Operation Environment	<ul style="list-style-type: none">• Location: Indoor, no direct sunlight, dust free, almost non-conductive pollution (Note below)• Relative Humidity: < 80%• Altitude: < 2000m• Temperature: 0°C to 40°C
Storage environment	<ul style="list-style-type: none">• Location: Indoor• Relative Humidity: < 70%• Temperature: -10°C to 70°C

Power cord for the United Kingdom

When using the power supply in the United Kingdom, make sure the power cord meets the following safety instructions.

NOTE: This lead/appliance must only be wired by competent persons



WARNING: THIS APPLIANCE MUST BE EARTHED

IMPORTANT: The wires in this lead are coloured in accordance with the following code:

Green/ Yellow:	Earth
Blue:	Neutral
Brown:	Live (Phase)



As the colours of the wires in main leads may not correspond with the coloured marking identified in your plug/appliance, proceed as follows:

The wire which is coloured Green & Yellow must be connected to the Earth terminal marked with either the letter E, the earth symbol  or coloured Green/Green & Yellow.

The wire which is coloured Blue must be connected to the terminal which is marked with the letter N or coloured Blue or Black.

The wire which is coloured Brown must be connected to the terminal marked with the letter L or P or coloured Brown or Red.

If in doubt, consult the instructions provided with the equipment or contact the supplier.

This cable/appliance should be protected by a suitably rated and approved HBC mains fuse: refer to the rating information on the equipment and/or user instructions for details. As a guide, a cable of 0.75mm² should be protected by a 3A or 5A fuse. Larger conductors would normally require 13A types, depending on the connection method used.

Any exposed wiring from a cable, plug or connection that is engaged in a live socket is extremely hazardous. If a cable or plug is deemed hazardous, turn off the mains power and remove the cable, any fuses and fuse assemblies. All hazardous wiring must be immediately destroyed and replaced in accordance to the above standard.

OVERVIEW

This chapter contains a brief introduction to GPP-3060/GPP-6030 including the main features and an overview of the front and rear panel. Use the Getting Started chapter on page 27 to start up instructions and how to setup the appropriate operation environment.

Key Features	16
Front Panel	18
Rear Panel.....	24
Constant Voltage/Constant Current Crossover Characteristics	26

Introduction

Overview The GPP-3060/GPP-6030 regulated DC power supply series are adjustable, multifunctional work stations. It has three independent outputs: two with adjustable voltage levels and one with fixed level selectable from 1.8V, 2.5V, 3.3V and 5V.

It can be used for logic circuits where various output voltage or current are needed, and for tracking mode definition systems where plus and minus voltages with insignificant error are required.

**Independent /
Tracking Series /
Tracking Parallel**

The three output modes of it, independent, tracking series, and tracking parallel, can be selected through pressing the TRACKING key on the front panel. In the independent mode, the output voltage and current of each channel are controlled separately. The isolation degree, from output terminal to chassis or from output terminal to output terminal, is DC500V.

In the tracking modes, both the CH1 and CH2 outputs are automatically connected in series or parallel; no need to connect output leads. In the series mode, the output voltage is doubled; in the parallel mode, the output current is doubled.

Load Mode It has additional Load function on both CH1 & CH2 with 3 modes: CV (Constant Voltage), CC (Constant Current) and CR (Constant Resistance), all of which can be selected through the function keys on the front panel. Voltage, current and resistance can be well regulated in each mode, respectively.

Constant Voltage/
Constant Current Each output channel is completely transistorized and well-regulated, and works in constant voltage (CV) or constant current (CC) mode. Even at the maximum output current, a fully rated, continuously adjustable output voltage is provided. For a big load, the power supply can be used as a CV source; while for a small load, a CC source. When in the CV mode (independent or tracking mode), output current (overload or short circuit) can be controlled via the front panel. When in the CC mode (independent mode only), the maximum (ceiling) output voltage can be controlled via the front panel. The power supply will automatically cross over from CV to CC operation when the output current reaches the target value. The power supply will automatically cross over from CC to CV when the output voltage reaches the target value. For more details about CV/CC mode operation, see page 26.

Automatic tracking mode The front panel display (CH1, CH2) shows the output voltage or current. When operating in the tracking mode, the power supply will automatically connect to the auto-tracking mode.

Display Change Function	It provides up to 6 display types, each of which can be well selected via setting. For details, see page 33.
Output Waveform Function	Under Source mode, user can customize a certain V/I sequential waveform output. Under Load mode, it is programmable for dynamic load (below 1Hz). For details, see page 54.
Front and rear output function	For the convenience of customers, GPP can be operated by the panel menu or remote command, so that it can be output on the front and rear panels, please refer to page 31.
Remote Control	To meet the various needs of customers, the GPP is designed for USB, GPIB ,LAN and RS-232 remote control. For details, see page 101.
Additional Function	Control signal of external switch is reserved for user. For details, see page 85.

Key Features

Features	<ul style="list-style-type: none">• Multiple Outputs:• Constant voltage and constant current operation (CV/CC).• Low noise, thermostatically controlled fan.• Compact, lightweight, standard rack mount conformity 3U, half Rack.• 4.3 inch TFT display.
Operation	<ul style="list-style-type: none">• Digital panel control.• Output on/off control (ON/OFF), and each channel can be controlled separately.• Digital voltage and current settings. (Key & Encode)• 10 groups of save/recall settings and 2 groups of power-on settings.<ul style="list-style-type: none">10 groups of save/recall Sequence.10 groups of save/recall Delay.10 groups of save/recall Record.• CH1/CH2 workable in Load Mode• 6 types display modes available with 4 contents and 2 waveforms respectively• Input/Output terminal (Control I/O)• Alarm buzzer (Beeper).• Key lock function (LOCK).• Front and rear output function• Multiple remote control interfaces (standard: RS-232, USB; optional: GPIB, LAN)

Protection Features	<ul style="list-style-type: none">• Overvoltage and overcurrent protection (OVP/OCP)• Overtemperature protection (OTP).• Polarity Reverse Protection• Overload Protection (OPP in Load mode)
Interface	<ul style="list-style-type: none">• Remote Control RS-232 (standard)• USB remote control. (standard)• Control I/O (standard)• LAN remote control (optional)• GPIB & LAN remote control (optional)

Front Panel

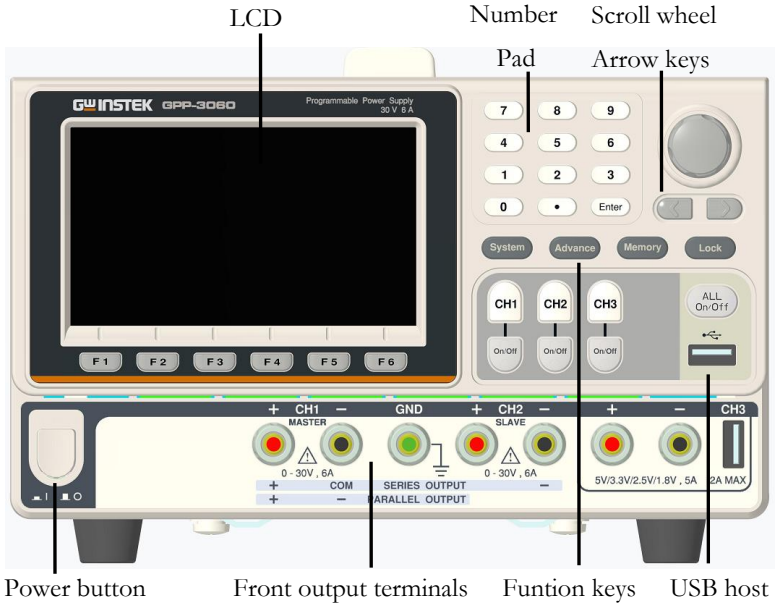

Display

Display Interface

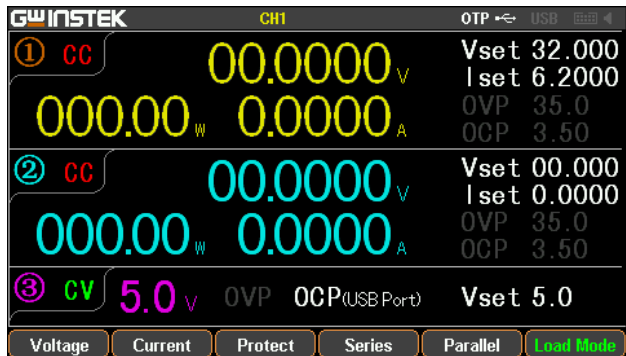

⚠ (Take GPP-3060 model as example)

Channel distribution Channel number and distribution vary by models with different colors identifications: CH1: **Yellow** CH2: **Blue** CH3: **Pink**
 CH1 is master and CH2 becomes yellow under tracking series and tracking parallel modes.

Single channel display



Channel no. Color of channel remains the original **①** when not in the state of setting.

Color of channel blinks between the original and orange **①** ↔ **①** when being set.

Channel status Display active channel state

Power supply: CH1/CH2: green **CV** or red **CC**

Load Mode: CH1/CH2: orange **CV CC CR**

Voltmeter Indicators Displays the output voltage with up to 6 digits of resolution. The default units are Volts (V).

CH1: **00.0000 V**

CH2: **00.0000 V**

CH3: **1.8 V**

Ammeter Indicator Displays the output current with up to 5 digits of resolution. The default units are ampere (A).

CH1: **0.0000** A

CH2: **0.0000** A

CH3: None

Setting Display Displays the voltage and current settings.

Vset 00.000

CH1/CH2: **Iset 1.0000**

CH3: displays setting of voltage only

Vset 1.8

Display OVP/OCP settings

CH1/CH2: **OVP** **OCP** , The CH3 OVP is a fixed value (approx. 5.5V), non-configurable and with only on or off switch available for user.

OCP is available only for USB output port (approx. 3.1A) **OVP** **OCP(USB Port)**

Status Indicator Display the set function/remote control interface

CH1 **OTP** ↔ **USB**  ◀

CH1: The active channel under setting status

OTP: The status of OTP protection mode

↔: The status of USB flash drive connected

USB: USB remotely disconnected

USB: USB remotely connected

: The status of control I/O connected

Others: when operating in the series/parallel tracking mode, the corresponding SER/PAR icons appear on the display.

when Sequence/Delay/Monitor/Recorder is activated, the corresponding SEQ/DLY/MON/REC icons appear on the display.

Function Keys

Power Button



Turns the power on or off.

On:

Off:

Channel select buttons



Each channel has its own button and promptly switchable among CH1-CH3 setting.

Output buttons Individual output



The ON/OFF button is operational individually by each channel. The Output key will light up when the output is on.

ON: ⇒

Output all

All ON:

⇒

Number pad







For parameter value setting



Scroll wheel & Arrow keys



Scroll wheel is used to set each parameter value, whilst arrow keys are used for parameter, menu selection and voltage/current fine adjustment. It is used to switch or operate the displayed waveforms under diagram display mode.

Function keys		The 6 function keys (F1-F6) display varied functions per different operations.
System key		It is used to set functions including Interface, Beeper, Backlight, etc. For details, refer to page 96.
Advance key		It is used for certain advanced functions like Sequence, Delay, Monitor, Recorder, etc.
Memory key		It is used to operate several functions including save and recall, etc., for set parameters. For details, refer to page 89.
Lock key		It is used to disable all the panel keys except for the Output key.
Unlock		Press the F6 button to unlock, which can disable remote control and return to panel operation.

Terminals

CH1 terminal		Power output terminal or load input terminal
CH2 terminal		Power output terminal or load input terminal

CH3 terminal

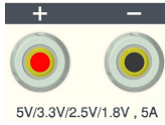

Power output terminal



Power output terminal

 Warning: The output current from the 2 terminals should Not exceed 5A.

GND terminal



Ground terminal

Rear Panel

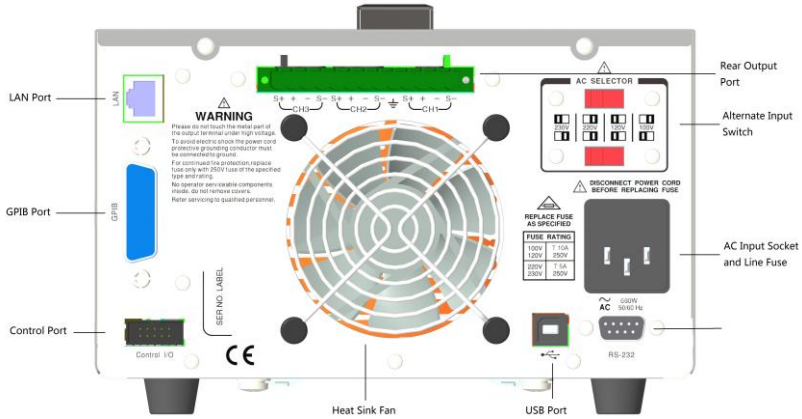

Terminals

Alternate input switch

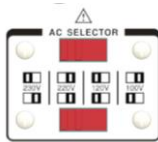

AC voltage selection:

100V/120V/220V/230V
±10%, frequency 50/60Hz

AC input socket and line fuse

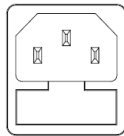

The AC input accepts 100V/120V/220V/230V AC. The frequency is 50Hz/60Hz.

Fuse:

100V/120V: T12A/250V,
220V/230V :T5A/250V,
slow-blow type, See page 213 for details.

Rear output terminal

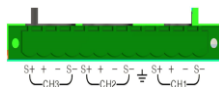

Operation and connection mode, see page29 and page43.

USB port



USB device port for remote control. See page 101 for details.

GPIB port

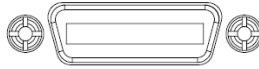

GPIB slave port for remote control. Abides to IEEE488.2 (SCPI) protocol. See page 108 for details.

LAN port



LAN port for remote control. See page 110 for LAN setting and operation details.

RS-232 port



RS-232 port for remote control. See page 104 for details.

Heat sink fan



It is used to discharge the heat inside the equipment through air flow.

Control I/O port

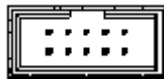

5 ports in all for input/output control. See page 85 for details of configuration.

Constant Voltage/Constant Current Crossover Characteristics

Background	The unit will switch automatically between constant voltage and constant current according to changes in the load.
CV mode	When the load current is less than the current setting, the unit operates in constant voltage mode, changing the current level according to the load but maintaining the set voltage level until the current reaches the set current level. The status indicator will show CV on the LCD when in CV mode.
Constant Current Mode	When the output current reaches the set current level, the unit switches operation to constant current mode. The status indicator will show CC on the LCD display. In CC mode, the current level is maintained and the voltage level is limited to less than the set voltage level to limit the output power from an overload. When the current drops below the set current level, the unit will revert back to CV mode.

Diagram

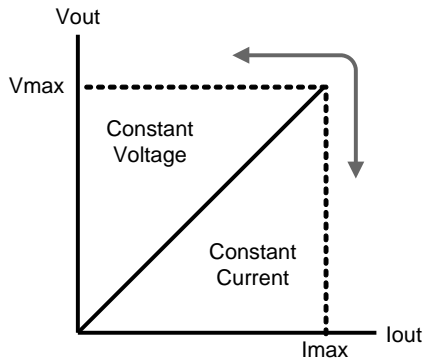

G **ETTING STARTED**

This chapter describes the start up procedures and the preparation that is necessary before operating the power supply.

Load Connection	29
Select front/rear panel output.....	31
Turning the Output On/Off.....	32

Start Up

Checking the AC Voltage

Before the power is turned on, confirm that the input power supply meets the following conditions:
100V/120V/220V/230V $\pm 10\%$,
50/60Hz

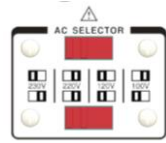

Connecting the AC power cord

The fuse is a slow-blow fuse.
5A(220V/230V),12A(100V/120V) ,
Confirm that the fuse is of the correct type and rating before connecting the power cord.

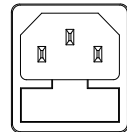

Turning the power on

Press the power button.



Turning the power off

To turn the power off, press the power button again.



Load Connection

Recommended Cables	Model	Specification	Usage
	GTL-104A	10A	Front panel terminal

Front panel wiring

Use the GTL-104A cables for the front panel source connections.



USB Type A only
(Greater than 4A)



Rear panel wiring

Self distribution wire:
+ / - need to be equipped with awg12 or above
S + / S - can be equipped with awg20, preferably twisted into twisted pair.
When in LOAD mode, there is no need to connect sense.

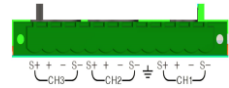

For safety considerations, please keep in mind that the wiring must be equivalent to the wiring on the front terminals.

Wire Gauge

Load wires must have enough current capacity to minimize cable loss and load line impedance. Voltage drop across a wire should not exceed 0.5V. The following list is the wire current rating at 450A/cm².

Wire Size(AWG)	Maximum Current (A)
20	2.5

18	4
16	6
14	10
12	16

Select front/rear panel output

Panel
Operation

1. Double click the system button



2. Press F1 (front) key to select front panel output, or press F2 (rear) key to select rear panel output.



3. You can see the switching output panel results from the corresponding display interface.



Note

The three channels will be switched at the same time for front or rear output.

Command
Set

Refer to page 120 for more details on remote commands chapter.

Turning the Output On/Off

Panel Operation

Press the *Output* key of each channel individually to turn the output on. The Output key will light-up when the output is on.



When the output is turned on, pressing the *Output* key again will turn the output off.



Press ALL ON/OFF key when it needs to output or turn off all channels simultaneously.



Command Set

Refer to page 120 for more details on remote commands chapter.

Automatic Output Shut Down

Any of the following actions will cause the output to be automatically shut down:

- Toggle between power output and load mode
- Independent/Tracking Series/Tracking Parallel operation
- Recall the saved setting
- OVP/ OCP/OPP/OTP protection is tripped.
- When Sequence/Delay/Monitor/Control IO fits the set conditions.

BASIC OPERATION

This chapter describes how to set various functions.

Display Change	34
Source Function	37
Independent Output Mode	43
Tracking Series and Tracking Parallel Modes	45
Load Function	50
Sequence Function	54
Set Sequence Output.....	54
Set Group Parameter	57
Construct Templet.....	58
Menu Tree.....	61
Save and Recall	63
Delay Function	66
Set Delay Output	66
Set Group Parameter	69
Menu Tree.....	72
Save and Recall	74
Monitor Function	77
Set Monitor	77
Recorder Function.....	81
Set Recorder.....	81
External I/O Control.....	85
Key Function Description	87

Display Change

Display Area

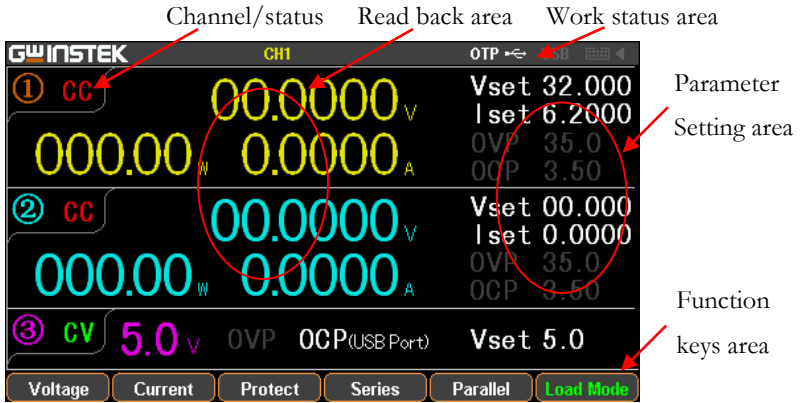

Warning

:

1. Under the Source interface:

Each channel has its own setting area (V/I/OVP/OCP) and read back status area (V/I/W).

2. Under the Load interface:

It is basically equivalent to Source interface with additional Load and OPP status displays.

Diverse display screens

In order to offer diverse information display of each channel to meet requirements from different users, the GPP provide several selections of different display screens as follows:

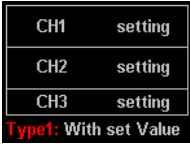
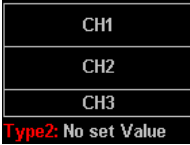
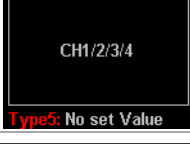
	Type	Display screens
Nomarl	Type1	
	Type2	
	Type4	
	Type5	
Waveform	Type6	
	Type7	

*Only Type 1, Type 4 and Type 7 have setting value display

*Type's selection: Advance key ->F1(Display) key->F1(Normal) key or F2(Waveform) key.

* Default factory display screen: Type1

The introduction to Type 6 display



- a represents the currently edited channel, which can be toggled through the channel button on the panel.
- b indicates the adjustable items of reference point for voltage/current/power respectively in the active channel. The one with a red triangular arrow is the active item to adjust, which can be toggled through the directional button on the panel.
- c stands for the vertical sensitivity for voltage/current/power respectively in the active channel.
- d stands for the horizontal sensitivity for time.
- e represents the output state of active channel and the open state of OVP/OCP.
- f indicates the output curve for voltage/current/power respectively in the active channel. The three curves have the identical color in common with slight difference in brightness, which corresponds to the brightness of b.
- g stands for the output reference point for voltage/current/power respectively in the active channel, which is adjustable ups and downs via scroll wheel.

Source Function



Description	Each channel is equipped with basic power functions and able to display both settings and read back value of V/I as well as output status	
Parameter description	Vset	Set output voltage of active channel. The range is as the following: CH1/CH2: 0.000V-32.000V (GPP-3060) 0.000V-62.000V (GPP-6030) CH3: 1.8V/2.5V/3.3V/5.5V
	Iset	Set limited current of active channel. The range is as the following: CH1/CH2: 0.0000A-6.2000A (GPP-3060) 0.0000A-3.2000A (GPP-6030)
	OVP	Set OVP. The range is as the following: CH1/CH2: 0.5V-35.0V (GPP-3060) 0.5V-65.0V (GPP-6030)
	OCP	Set OCP. The range is as the following: CH1/CH2:

0.05A-6.50A (GPP-3060)

0.05A-3.50A (GPP-6030)

Parameter Setting (CH1 for example)

Voltage

Press the F1 key corresponding to Voltage to activate voltage setting area on LCD (red font color with the underline indicator).



(a) Input digit with number pad (0-9,.) and press unit key F1(V) or F2(mV) to confirm:

Input 6.543V:



(b) Step input:

Press the left or right arrow buttons to select high and low level that require fine-tune (underline below the corresponding number value), and scroll the scroll wheel to increase or decrease setting value.



Current

Press the F2 key corresponding to Current to activate current setting area on LCD (red font color with the underline indicator).

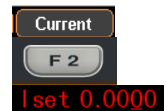

(a) Input digit with number pad (0-9,.) and press unit key F1(A) or F2(mA) to confirm:

Input 1.543V:



(b) Step input:

Press the left or right arrow buttons to select high and low level that require fine tune (underline below the corresponding number value), and scroll the scroll wheel to increase or decrease setting value.



OVP

Press F3 key to enter the Protect menu.



Press F3 key to open OVP function. OVP display will change from gray to white font.



Press the F1 key to enter OVP setting area on LCD, which will be thus activated (red font color with the underline indicator).



(a) Input digit with number pad (0-9,.) and press unit key F1(V) or

F2(mV) to confirm:



(b) Step input:
 Press the left or right arrow buttons to select high and low level that require fine tune (underline below the corresponding number value), and scroll the scroll wheel to increase or decrease setting value.



OCP

Press F3 key to enter the Protect menu.

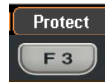

Press F3 key to open OCP function. OCP display will change from gray to white font.



Press the F2 key to enter OCP setting area on LCD, which will be thus activated (red font color with the underline indicator).



(a) Input digit with number pad (0-

9,.) and press unit key F1(A) or F2(mA) to confirm:

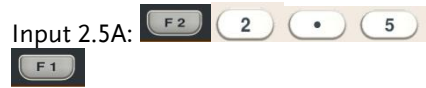

 **CAUTION:**

There's no proper sequence between turning on OVP/OCP functions and setting OVP/OCP value.

Either step input or number pad input is applicable for setting parameter value.

Operation	ON/OFF	Output ON/OFF control. Output is open when output lights up; whilst output is off when output lights out.
	All ON/OFF	<ol style="list-style-type: none"> 1. When the output state of all channels is identical, press All ON/OFF to perform the opposite operation. 2. When the output of all channels is inconsistent, press All ON/OFF will close the open channel of the output.
State description	CV/CC	Constant voltage displays  in green CV, while constant current displays in red CC.
	OVP/OCP	OVP/OCP displays in white when OVP is not in activation.

OVP/OCP displays in red and output is off when OVP is activated.

OVP/OCP displays in gray when OVP/OCP functions are off.

Independent Output Mode

Description Each channel within the models is apart from one another and capable of operations including independent setting and individual output, etc.

Front panel connection

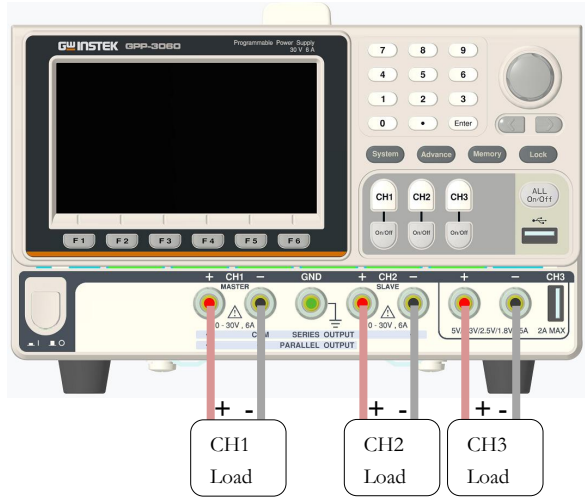

Rear panel with sense connection

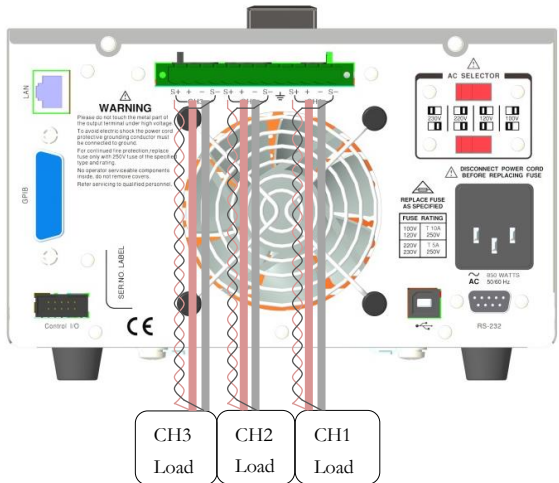

Voltage/Current Rating	CH1/CH2: 30V/6A x 2 (GPP-3060) 60V/3A x 2 (GPP-6030) CH3: 1.8V/2.5V/3.3V/5V/5A x 1 USB Port Output:3A
Setting	1. Press F4 or F5 button for operating the corresponding Independent to enter the Independent function. 2. For setting operation of parameter, refer to page 38.
Output	The independent button ON/OFF of each channel is available, while All ON/OFF button is available for all channels.

Tracking Series and Tracking Parallel Modes

Description Tracking series operation doubles the Voltage capacity of the GPP by internally connecting CH1 (Master) and CH2 (Slave) in series and combining the output to a single channel. CH1 (Master) controls the combined Voltage output level.

Tracking series without common terminal

Front panel connection

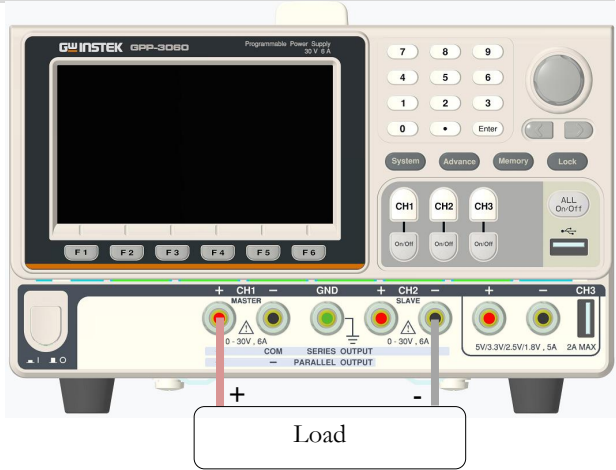

Rear panel with sense connection

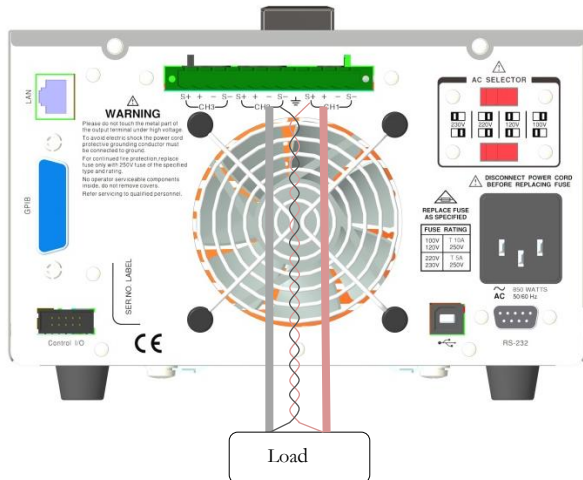

Output rating	0 - 60V/0 - 6A (GPP-3060) 0 - 120V/0 - 3A (GPP-3060)
Setting	<ol style="list-style-type: none">1. Press F4 or F5 button for operating the corresponding Series to enter the tracking series function. Yellow SER will be shown on the status area.2. Press CH1 button to proceed to CH1/CH2 voltage setting and CH1 limit current setting.3. Press CH2 button to proceed to CH2 limit current setting.4. For setting operation of parameter, refer to page 38.
Output	The button ON/OFF of CH1/CH2 is individually available, while All ON/OFF button is available for all channels.

Tracking series with common terminal

Front panel connection

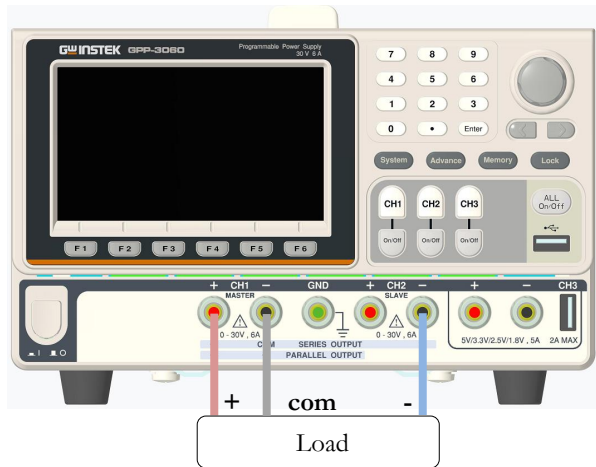

Rear panel with sense connection

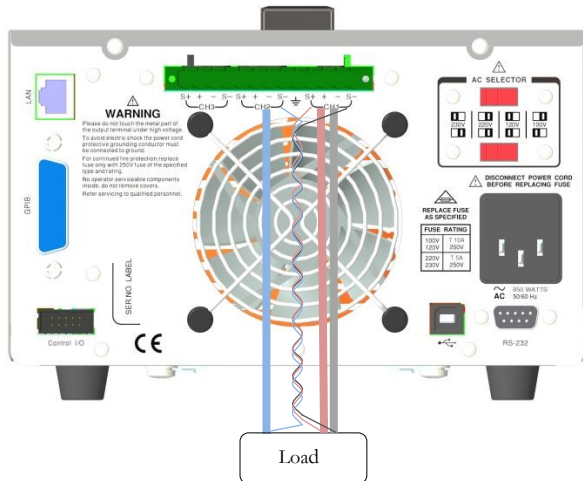

Output rating

- 0-30V/0-6A for CH1+ - COM (GPP-3060)
- 0-30V/0-6A for CH2- - COM (GPP-3060)
- 0-60V/0-3A for CH1+ - COM (GPP-6030)
- 0-60V/0-3A for CH2- - COM (GPP-6030)

- Operation**
1. Press F4 or F5 button for operating the corresponding Series to enter the tracking series function. Yellow SER will be shown on the status area.
 2. Press CH1 button to proceed to CH1/CH2 voltage setting and CH1 limit current setting.
 3. Press CH2 button to proceed to CH2 limit current setting.
 4. For setting operation of parameter, refer to page 38.
- Output**
- The button ON/OFF of CH1/CH2 is individually available, while All ON/OFF button is available for all channels.

⚠ CAUTION: under Tracking series mode, CH1 is master, CH2 is slave. Thus, output voltage setting is not available for CH2.

CH1/CH2 Tracking Parallel Mode

Front panel connection

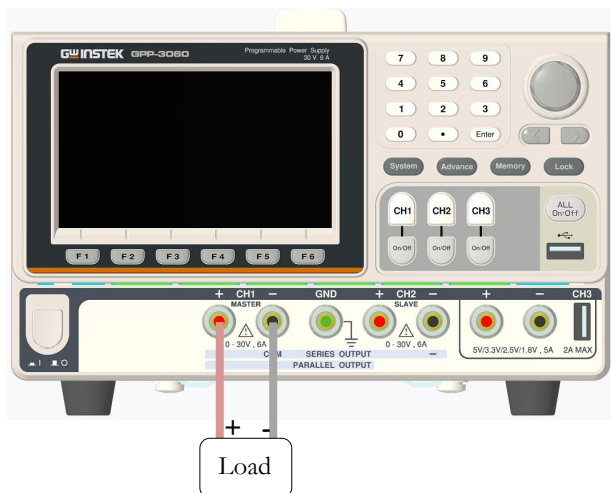

Rear panel with sense connection

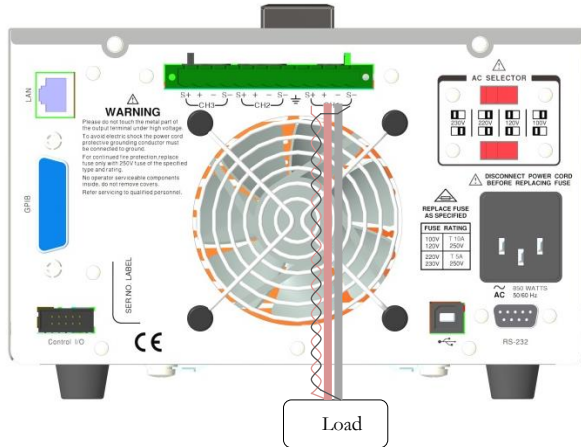

Output raing 0-30V/0 -12A(GPP-3060)
 0 -60V/0 -6A (GPP-6030)

- Operation
1. Press F4 or F5 button for operating the corresponding Parallel to enter the tracking parallel function. Yellow PAR will be shown on the status area.
 2. Press CH1 button to proceed to CH1/CH2 voltage/current setting.
 4. For setting operation of parameter, refer to page 38.

Output The button ON/OFF of CH1/CH2 is individually available, while All ON/OFF button is available for all channels.

⚠ CAUTION: under tracking parallel mode, CH1 is master, whilst CH2 is slave. Thus, output voltage/current setting is not available for CH2.

Load Function

Description CH1/CH2 can be set to the Load Mode function, under which both tracking series and tracking parallel function are Not available.

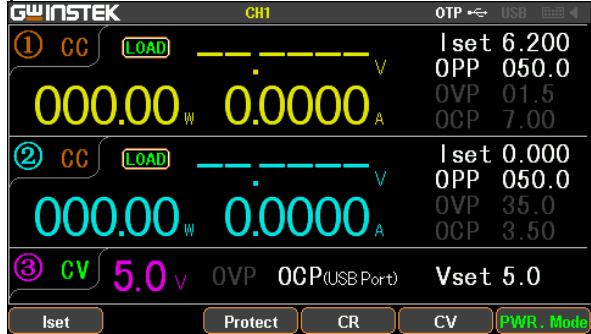

Note

The voltage ($\geq 1V$) or --- (<1V) pertaining to port appears when Output is Off.

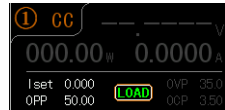

In LOAD mode, the rear panel does not need to be connected with sense.

Parameter Description	Load	Under PWR. mode, press F6 (Load Mode) to enter the Load mode. LCD will display the status LOAD .
	Vset	Set rating range of voltage value under Load mode of active channel: 1.50V-32.00V(GPP-3060) 1.50V-62.00V(GPP-6030)
	Iset	Set rating range of current value under Load mode of active channel 0.000A-6.200A(GPP-3060) 0.000A-3.200A(GPP-6030)

	Rset	Set rating range of resistance value under Load mode of active channel 1 Ω-1000 Ω
	Others	OPP : Fixed 50W of single channel, non-revisable OVP/OCP : identical to Source

Parameter setting	Vset	<p>Press F4 or F5 button for operating the corresponding (CV) mode followed by F1 button (Vset). The voltage setting area on LCD will be activated and appears Vset 00.00 (red font color with the underline indicator).</p> <p>(a) number pad (0-9,.) input; press unit button F1 (V) or F2 (mV) button to confirm:</p> <p>Input 6.54V:</p> <div style="display: flex; justify-content: space-around; align-items: center;"> <div style="display: flex; flex-direction: column; gap: 5px;"> <div style="display: flex; gap: 5px;"> <div style="border: 1px solid black; padding: 2px 5px;">F1</div> <div style="border: 1px solid black; padding: 2px 5px;">6</div> </div> <div style="display: flex; gap: 5px;"> <div style="border: 1px solid black; padding: 2px 5px;">4</div> <div style="border: 1px solid black; padding: 2px 5px;">F1</div> </div> </div> <div style="display: flex; gap: 20px;"> <div style="border: 1px solid black; padding: 2px 5px;">•</div> <div style="border: 1px solid black; padding: 2px 5px;">5</div> </div> </div>
	Iset	<p>(b) Step input: Press the left or right arrow buttons to select high and low level that require fine tune (underline below the corresponding number value), and scroll the scroll wheel to increase or decrease setting value.</p> <p>Press F4 or F5 button for operating the corresponding (CC) mode</p>



followed by F1 button (Iset). The current setting area on LCD will be activated and appears **Iset 1.000** (red font color with the underline indicator).

(a) number pad (0-9,.) input; press unit button F1 (A) or F2 (mA) button to confirm:

Input 1.543A:



(b) Step input: Press the left or right arrow buttons to select high and low level that require fine tune (underline below the corresponding number value), and scroll the scroll wheel to increase or decrease setting value.



Rset

Press F4 or F5 button for operating the corresponding (CR) mode followed by F1 button (Rset). The current setting area on LCD will be activated and appears **Rset 0000** (red font color with the underline indicator).

(a) number pad (0-9,.) input; press unit button F1 (OHM) to confirm:

Input 52Ω:



(b) Step input: Press the left or right arrow buttons to select high and low level that require fine tune (underline below the corresponding number value), and scroll the scroll wheel to increase or decrease setting value.



	OVP OCP	The setting method is identical to Source.
Operation	ON/OFF	The button ON/OFF of CH1/CH2 is individually available, while All ON/OFF button is available for all channels.
Mode	CV CC CR	Font color appears in orange under Load mode. CV CC CR



Note

In CR mode, the external power supply must provide the current required for $I = V / R$, otherwise the output ports V and I will fluctuate.

Sequence Function

Description This function can be used for practical applications when different voltage waveforms are required to be output. Users can edit the output waveform according to their needs. The amplitude range of the output waveform is the output voltage range of power supply. The setting range for output waveform duration is 1s (duration calculation: Time x Groups x Cycles) and the resolution is 1s.

⚠ Caution: This feature is applicable to both CH1 and CH2.

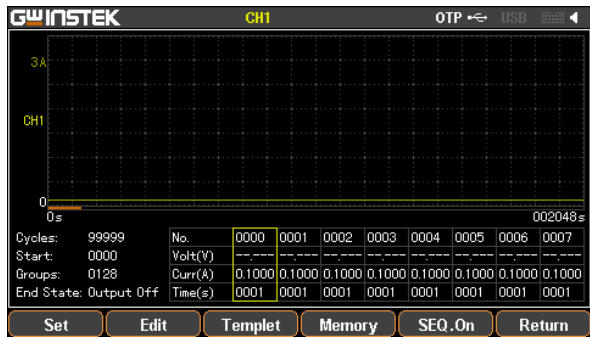

Set Sequence Output

Parameter Description	Cycles	Cycle number, 1 represents a cycle of single period, whilst 2 indicate a cycle with 2 periods, and so on. The range is from 1 to 9999 or Infinite.
	Start	The number to execute, 0 indicates the execution starts from the group 0, while 1 indicates it begins from the group 1, and so on. The range is from 0 to 2047.

	Groups	The number to be executed. It can NOT exceed 2048 for Start+Groups.
	End State	There're 2 statuses after the necessary Group and Cycle are executed: output termination or being hold with the last step.
Parameter Setting	Cycles	Press the Advance key on control panel. Select F2 (Sequence) function. Press F1 (Set) button followed by selecting F1 (Cycles). The setting on LCD is activated and appears in red font color Cycles: 99993 . Use number pad to set the parameters directly and then press the F1 (Done) button to confirm; or use arrow keys along with scroll wheel to complete the setting. Press and hold the F5 (Infinite) button if Infinite execution is in need.
	Start	Under the Sequence function, press F1 (Set) button followed by selecting F2 (Start). The setting on LCD is activated and appears in red font color Start: 2047 . Use number pad to set the parameters directly and then press the F1 (Done) button to confirm; or use arrow keys along with scroll wheel to complete the setting.
	Groups	Under the Sequence function, press F1 (Set) button followed by selecting F3 (Groups). The setting on LCD is activated and appears in red font color Groups: 0001 . Use number pad

to set the parameters directly and then press the F1 (Done) button to confirm; or use arrow keys along with scroll wheel to complete the setting.

End State

Under the Sequence function, press F1 (Set) button followed by selecting F4 (End State), and 2 statuses Last/Output off will appear in turn on LCD **End State: Output Off**. The one displaying is what's called the current status.

Operation ON/OFF

Press the F5 (SEQ.On) button. When the output is on, the Output key will light up. When the output is off, the Output key will not be lit. SEQ will appear in the status area (yellow for CH1 only, blue for CH2 only, while white for both on).

In Sequence ON, the F1 (Restart) button appears, it means that start from the first; in CH1/CH2 running sequence, the F2 (Sync) button appears, it means that two channels start from the first at the same time.



CAUTION

If the channel has been in Output ON before Sequence function, the status remains unchanged until SEQ.On so that Sequence starts to output.

Set Group Parameter

Description	Each Group consists of Voltage, Current and Time. Therefore, properly confirm parameter of each group is correct before setting Sequence output.	
Parameter Description	No. Voltage Current Time	Group number. Maximum 2047 Voltage setting of each group. Current setting of each group. Execution duration of each group. Range: 1S – 300S
Parameter Setting	No.	Under the Sequence function, press F2 (Edit) button followed by selecting F1 (No.). The setting on LCD is activated and appears in red font color No. 0000 . Use number pad to set the parameters directly and then press the F1 (Done) button to confirm; or use arrow keys along with scroll wheel to complete the setting. The F4 (Page Up)key and F5 (Page Down) key can jump directly to the previous or next page,each 8 groups is a Page.
	Voltage	Under the Sequence function, press F2 (Edit) button followed by selecting F3 (Voltage). The setting on LCD is activated and appears in red font color Volt(V) 05.000 . Use number pad to set the parameters directly and then press the F1 (V) or F2 (mV) button to confirm; or use arrow keys along with scroll wheel to complete the setting.

Current	Under the Sequence function, press F2 (Edit) button followed by selecting F4 (Current). The setting on LCD is activated and appears in red font color Curr(A) 0.1000 . Use number pad to set the parameters directly and then press the F1 (A) or F2 (mA) button to confirm; or use arrow keys along with scroll wheel to complete the setting.
Time	Under the Sequence function, press F2 (Edit) button followed by selecting F2 (Time). The setting on LCD is activated and appears in red font color Time(s) 0001 . Use number pad to set the parameters directly and then press the F1 (Second) button to confirm; or use arrow keys along with scroll wheel to complete the setting.

Construct Templet

Description This function can be used for practical applications when different voltage waveforms are required to be output. Users can edit the output waveform according to their needs. The built-in Sine, Pulse, Ramp, Stair Up, Stair Dn, Stair UpDn, Exp Rise, Exp Fall waveforms are practical per usage.

Parameter Description	Object	To edit Voltage or Current
	Type	Select the built-in waveforms including Sine, Pulse, Ramp, Stair Up, Stair Dn, Stair UpDn, Exp Rise,

		Exp Fall.
	Max Value	Set the max. value of waveform voltage/current
	Min Value	Set the min. value of waveform voltage/current
	Start	Set the initial group number of waveform. Maximum: 2037
	Points	Select the required points. Range: 10-2047
	Inverted	Invert the selected waveform
Parameter Setting	Object	Press the F1 (Object) button to select Voltage Object Voltage /Current Object Current in turn. Simply stop at the parameter which is in need of setting.
	Type	After pressing the F2 (Type) button, select the button corresponding to the applicable waveform. Up to 8 default waveforms are available for selection.
	Max Value	Press the F3 (Max Value) button. The setting on LCD will be activated and appears in red front color Max Value 32000V . Use number pad to set the parameters directly and then press the F1 (V/A) or the F2 (mV/mA) button to confirm; or use arrow keys along with scroll wheel to complete the setting.

Min Value Press the F4 (Min Value) button. The setting on LCD will be activated and appears in red front color. Use number pad to set the parameters directly and then press the F1 (V/A) or the F2 (mV/mA) button to confirm; or use arrow keys along with scroll wheel to complete the setting.

Start Press the F5 (More) button and then press the F1 (Start) button. The setting on LCD will be activated and appears in red front color **Start 1900**. Use number pad to set the parameters directly and then press the F1 (Done) to confirm; or use arrow keys along with scroll wheel to complete the setting.

Points Press the F2 (Points) button. The setting on LCD will be activated and appears in red front color **Points 0123**. Use number pad to set the parameters directly and then press the F1 (Done) to confirm; or use arrow keys along with scroll wheel to complete the setting.

Interval Setting the time interval of each point of the current selected template (i.e. the duration of output of each set of timing parameters) ,it can be set from 1s to 300s. Press the F3 (Interval) button. The setting on LCD will be activated and appears in red front color **Interval 005**. Use number pad to set

the parameters directly and then press the F1 (Done) to confirm; or use arrow keys along with scroll wheel to complete the setting.

Inverted Press the F4 (Inverted) button. On (inverted) **Inverted On** and Off (non-inverted) **Inverted Off** appear on LCD in turn. Simply stop at the status which is required.

Construct Construct Press the F5 (Construct) to complete construction.

Menu Tree

Description User is able to well understand the overall functions of Sequence via menu tree, which is put in proper order by tiers. The Return key is used for back to the parent menu. See the construction below:

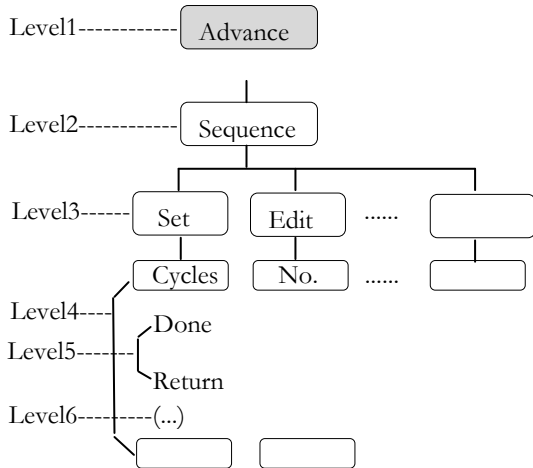

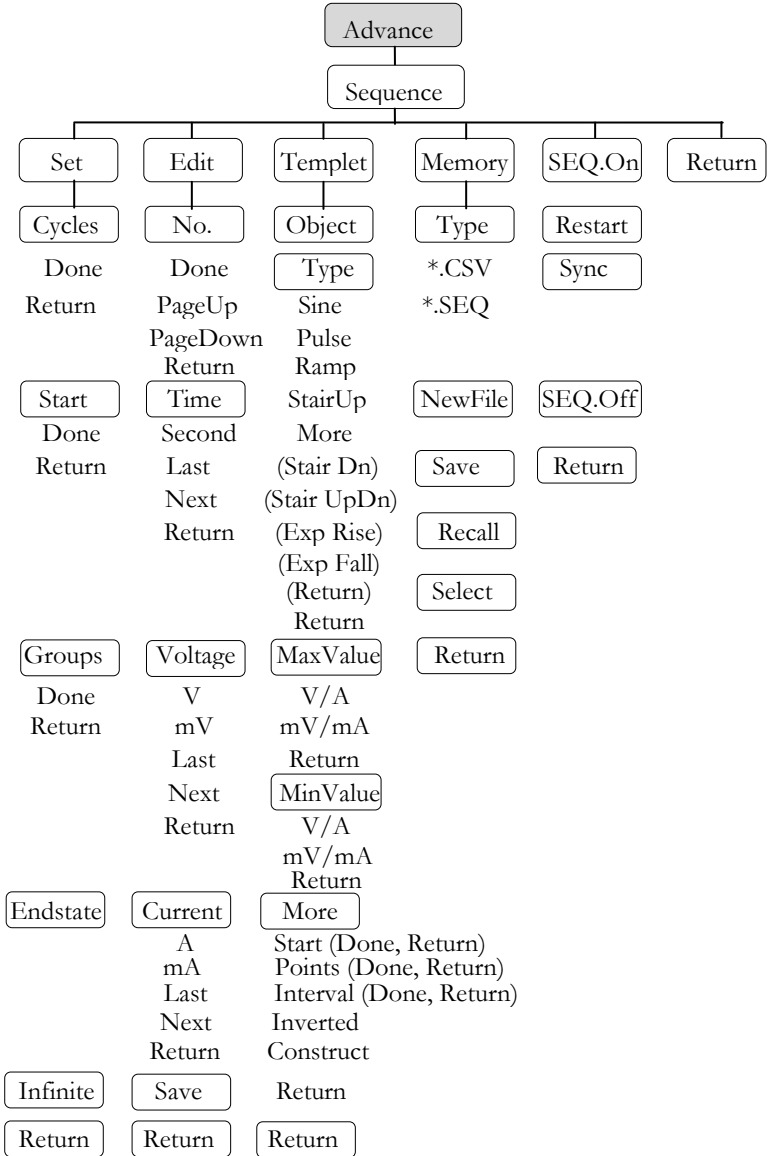

⚠ Note: In the Memory menu, Type/*.CSV/*.SEQ/New File/Select appear only when flash drive is plugged in.

Save and Recall

Description	GPP models can save and recall the Sequence data from internal 10 groups or flash drive.	
Parameter Description	Type	Available for *.CSV or *.SEQ file type
	New File	Available for creating new *.CSV or *.SEQ file type
	Save	Save the Sequence data to the specified file.
	Recall	Recall the data saved in the specified file.
	Select	Select the file folder in need.

Operation Internal storage 1. In the Sequence menu, press F4 (Memory) button to enter the page as figure show below.

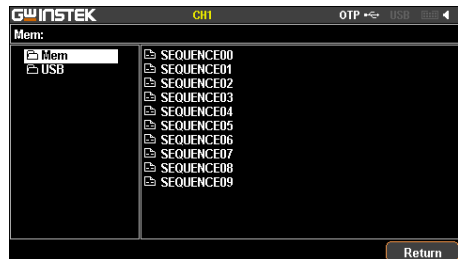

2. Press right arrow button to enter the list of 10 groups.



3. Rotate the scroll wheel (Encode) to select target file.

4. Press F3 (Save) button to save the settings of Sequence into the corresponding file.

5. Press the F4 (Recall) button to recall the Sequence file of list to the current sequence settings when necessary.

Flash drive storage

1. Plug flash drive in before rotating the scroll wheel (Encode) to select flash drive.

2. Press right arrow button to enter the root directory of flash drive.

3. Press F1 (Type) button to select required file type *.CSV or *.SEQ.

4. Rotate the scroll wheel (Encode) to select target file.

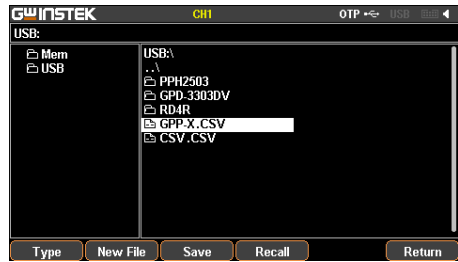

5. Press F3 (Save) button to save the settings of Sequence into the corresponding file.

6. Press the F4 (Recall) button to recall the Sequence file of list to the current sequence settings when necessary.

Delay Function

Description It is necessary to output a series of pulse in real applications. This function is available when voltage is constant. Output waveform can be edited per user's preference. The amplitude range of the output waveform is the output voltage range of power supply. The setting range for output waveform duration is 1s ~ Infinite (duration calculation: Time x Groups x Cycles) and the resolution is 1s.

 **Note:** This feature is applicable to both CH1 & CH2.

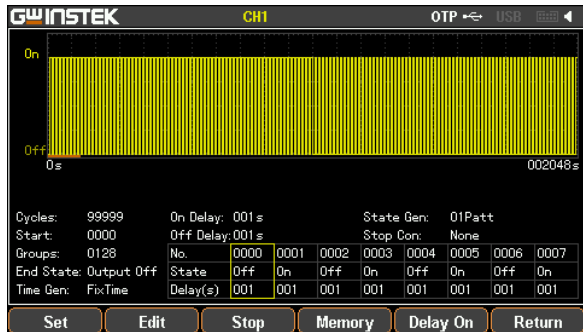

Set Delay Output

Parameter Description	Cycles	Cycle number, 1 represents a cycle of single period. 2 represents a cycle with 2 periods, and so on. The range is from 1 to 9999 or Infinite.
	Start	The number (No.) to start execute. 0 indicates the execution starts from the group 0, while 1 indicates it begins from the group 1, and so on. The range is from 0 to 2047.

	Groups	The number to be executed. It can NOT exceed 2048 for Start+Groups.
	End State	There're 3 statuses after the necessary Group and Cycle are executed: output termination or output on or being hold with the last step.
	Stop Condition	Halt the current operation based on the set condition of Voltage/Current/Power.
Parameter Setting	Cycles	Press the Advance key on control panel. Select the F3 (Delay) function. Press the F1 (Set) button followed by selecting F1 (Cycles). The setting on LCD is activated and appears in red font color Cycles: 99993 . Use number pad to set the parameters directly and then press the F1 (Done) button to confirm; or use arrow keys along with scroll wheel to complete the setting. Press and hold the F5 (Infinite) button if Infinite execution is in need.
	Start	Under the Delay function, press the F1 (Set) button followed by selecting the F2 (Start). The setting on LCD is activated and appears in red font color Start: 2047 . Use number pad to set the parameters directly and then press the F1 (Done) button to confirm; or use arrow keys along with scroll wheel to complete the setting.

Groups Under the Delay function, press the F1 (Set) button followed by selecting the F3 (Groups), the setting on LDC will be activated and appears in red font **Groups: 0001**. Use number pad for direct setting followed by pressing F1 (Done) key to confirm; or use arrow keys along with scroll wheel to complete setting.

End State Under the Delay function, press the F1 (Set) button followed by selecting the F3 (Groups), and 3 statuses Last/Output on/ Output off will appear in turn on LCD **End State: Output Off**. The one displaying is what's called the current status.

Stop Condition Under the Delay function, a condition of stopping operation can be set. When the instrument monitors the condition, the execution of delay function can be terminated. press the F3 (Stop) button and halt the operation by setting voltage F2 (Voltage), current F3 (Current) and power F4 (Power), or Stop infinitely by F1 (None). The output state of the instrument after stopping is determined by the setting of "End State".

Operation	ON/OFF	Press the F5 (Delay On) button. Output is open when output lights up; whilst output is off when output lights out. DLY appears on the status bar (yellow for CH1, blue for CH2, and white for both CH1 & CH2 on). At this time, the F5 button will become "Delay OFF", which can
-----------	--------	--

perform the function of closing Delay .

In Delay ON, the F1 (Restart) button appears, it means that start from the first; in CH1/CH2 running delay, the F2 (Sync) button appears, it means that two channels start from the first at the same time.



Warning

If the channel has been in Output ON before Delay function, the status remains unchanged until Delay.On so that the corresponding waveform starts to output.

Set Group Parameter

Description Each Group consists of Vltage, Current and Time. Therefore, properly confirm parameter of each group is correct before setting Delay output.

Parameter Description	No.	Group number. Maximum 2047
	State	Output status of each group: On, Off
	Time	Execution duration of each group. Range: 1s - 300s
	Pattern	Set the initial status of initial group. 01 Patt: start from Off; 10Patt: start from On
	Time set	It is used to generally set the pattern of time change. Model is for the changes covering fix (FixTime), increase (Increase) and decline

(Decline). Base Time is for setting time of initial Group. Step is for setting time interval of neighboring Group.

Parameter Setting	No.	Under the Delay function, press the F2 (Edit) button followed by selecting the F1 (No.). The setting on LCD is activated and appears in red font color No. 0000 . Use number pad to set the parameters directly and then press the F1 (Done) button to confirm; or use arrow keys along with scroll wheel to complete the setting. The F4 (Page Up)key and F5 (Page Down) key can jump directly to the previous or next page,each 8 groups is a Page.
	State	Under the Delay function, press the F2 (Edit) button, and then the F2 (State) button followed by selecting F1 (On), F2 (Off) or F3 (Inverted) to set output On/Off status of each group. Press the F4 (Last) key for the previous one and the F5 (Next) key for the next one
	Time	Under the Delay function, press the F2 (Edit) button followed by selecting the F3 (Time). The setting on LCD is activated. Use number pad to set the parameters directly and then press the F1 (Second) button to confirm; or use arrow keys along with scroll wheel to complete the setting. Press the F4 (Last) key for the previous one and the F5 (Next) key for the next one.

Pattern	Under the Delay function, press the F2 (Edit) button followed by selecting F4 (Pattern), and then set up via F1 (01Patt) and F2 (10Patt). The live setting result appears on the LCD.
Time Set	Under the Delay function, press the F2 (Edit) button followed by selecting the F5 (Time Set), and then set time change patterns of each group, There are 3 types"Time Gen" options:fix (FixTime), increase (Increase) and decline (Decline) of which are available) via F1 (Model). The live setting result appears on the LCD.
On Delay Off Delay	When fix (FixTime) is set in Time Set, it's available to set the time value of both F2 (On Delay) and F3 (Off Delay)at the same time.
Base Time Step	When increase (Increase) or decline (Decline) is set in Time Set, it's available to set the time value of F2 (Base Time) start time and F3 (Step)group change at the same time.

Menu Tree

Description User is able to well understand the overall functions of Delay via menu tree, which is put in proper order by layer. The Return key is used for back to the parent menu. See the construction below:

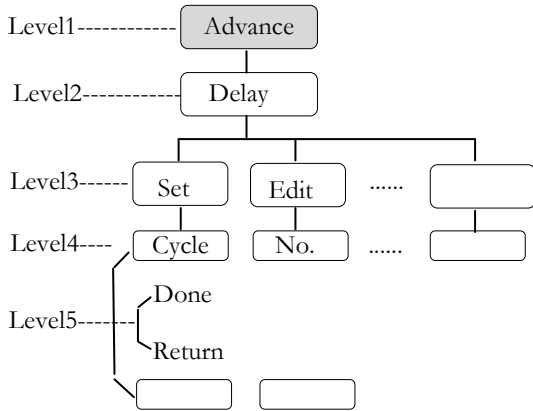

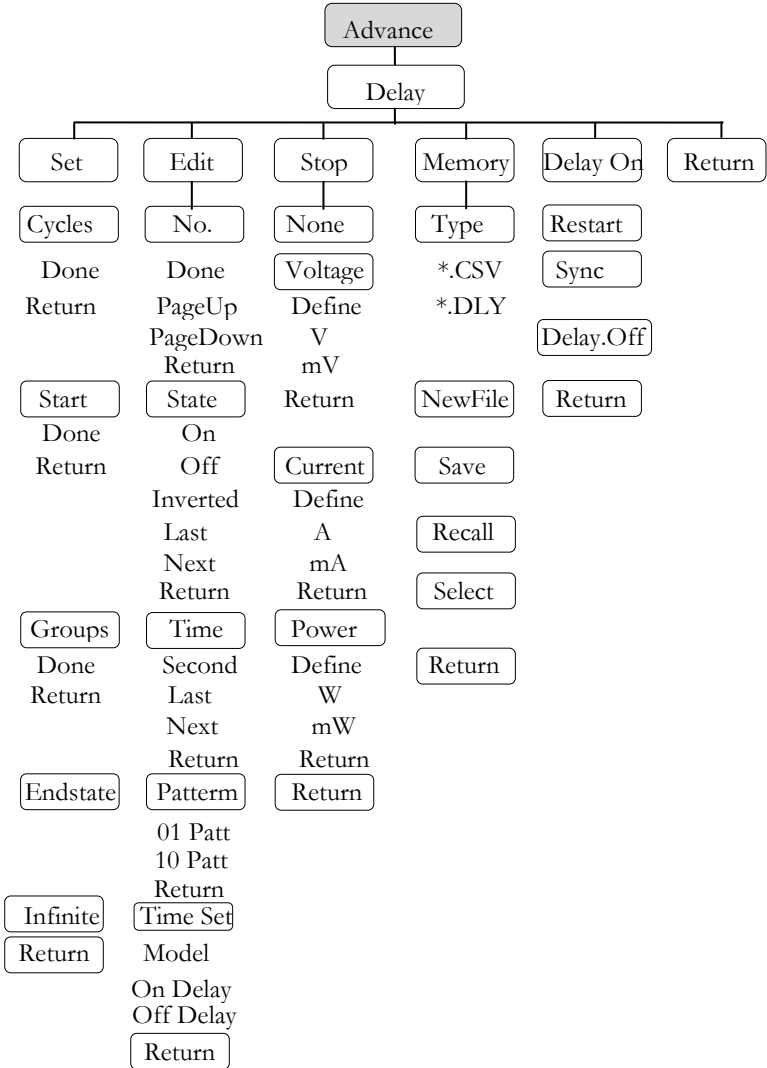

⚠ Note: In the Memory menu, Type/*CSV/*DLY/New File/Select appear only when flash drive is plugged in.

Save and Recall

Description	GPP models can save and recall the Delay data from internal 10 groups or flash drive.	
Parameter Description	Type	Available for *.CSV or *.DLY file type
	New File	Available for creating new *.CSV or *.DLY file type
	Save	Save the delay data to the specified file.
	Recall	Recall the data saved in the specified file.
	Select	Select the file folder in need.
Operation	Internal Storage	1. In the Delay menu, press F4 (Memory) button to enter the page as figure show below.

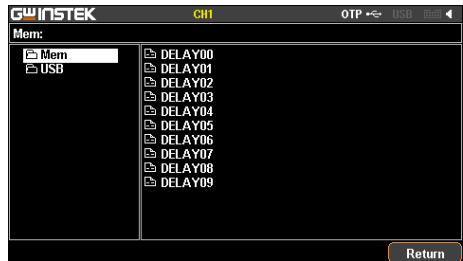

2. Press right arrow button to enter the file list of 10 groups.

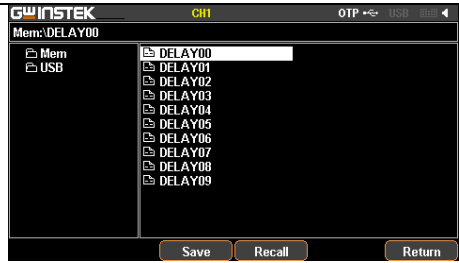

3. Rotate the scroll wheel (Encode) to select target file.

4. Press F3 (Save) button to save the settings of Delay into the corresponding file.

5. Press the F4 (Recall) button to recall the Delay file of list to the current sequence settings when necessary.

Flash drive storage

1. Plug in flash drive before rotating the scroll wheel (Encode) to select flash drive.

2. Press right arrow button to enter the root directory of flash drive.

3. Press F1 (Type) button to select required file type *.CSV or *.DLY.

4. Rotate the scroll wheel (Encode) to select target file.

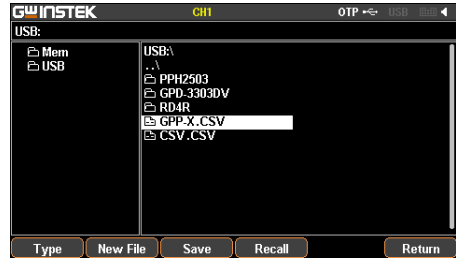

5. Press F3 (Save) button to save the settings of Delay into the corresponding file.

6. Press the F4 (Recall) button to recall the Delay file of list to the current sequence settings when necessary.

Monitor Function

Description In order to have well understanding of the channel under long-term output, the GPP series has the additional live monitor function, which helps guarantee load status of client via halting operation based on certain preset conditions.

 **Warning:** this feature is Not applicable to CH3.



Set Monitor

Parameter Description	Voltage	Set condition of monitor of voltage.
	Current	Set condition of monitor of current.
	Power	Set condition of monitor of power.
	Stop Type	Set status after halt. 3 types are available, output disable, content notice and audible alarm.
	Select	To confirm if voltage/current/power is selected as monitor object. White font stands for selected, while gray font represents

		not selected.
Parameter Setting	Voltage	<p>Press the Advance key on control panel. Select the F4 (Monitor) function followed by pressing the F1 (Voltage) button to enter the voltage setting.</p> <ol style="list-style-type: none"> 1. Press the F1 (Set) button. The setting on LCD is activated and appears in red font color. Use number pad to set the parameters directly; or use arrow keys along with scroll wheel to complete the setting. 2. Press the F4 (Define) button to define terminated condition. 3. Press the F5 (Logic) button to define logical pattern of other conditions.
	Current	<p>Press the Advance key on control panel. Select the F4 (Monitor) function followed by pressing the F2 (Current) button to enter the current setting.</p> <ol style="list-style-type: none"> 1. Press the F1 (Set) button. The setting on LCD is activated and appears in red font color. Use number pad to set the parameters directly; or use arrow keys along with scroll wheel to complete the setting. 2. Press the F4 (Define) button to define terminated condition.

		<p>3. Press the F5 (Logic) button to define logical pattern of other conditions.</p>
Power		<p>Press the Advance key on control panel. Select the F4 (Monitor) function followed by pressing the F3 (Power) button to enter the power setting.</p> <ol style="list-style-type: none">1. Press the F1 (Set) button. The setting on LCD is activated and appears in red font color. Use number pad to set the parameters directly; or use arrow keys along with scroll wheel to complete the setting.2. Press the F4 (Define) button to define terminated condition.3. Press the F5 (Logic) button to define logical pattern of other conditions.
Stop Type		<p>Press the Advance key on control panel. Select the F4 (Monitor) function followed by pressing the F4 (Outoff) button to set output disable; select F2 (Alarm) to set content notice; select F3 (Beeper) to set audible alarm. Buzzer should be turned on in system settings when Beeper is enabled, refer to page 96.</p>
Operation	ON/OFF	<p>Press the F5 (MON. On) button to enter live monitor. MON appears on the status bar (the color of channel</p>

remains the original when single channel is enabled, whilst it turns to white when multiple channels are activated).

Recorder Function

Description In order to have well understanding of the channel under long-term output, the GPP series has the additional live record function, which saves file via media for further analysis later.

 **Warning:** this feature is Not applicable to CH3.



Set Recorder

Parameter Description	Period	Set period of each recorded.
	Groups	Set recorded group number.
	Channel	Set recorded channel.
	Memory	Set saving location of record.

Parameter Setting Period Press the Advance key on control panel. Select F5 (Recorder) function. Press F1 (Period) button to enter setting of recorded period. The setting on LCD is activated and appears in red font color. Use

	<p>number pad to set the parameters directly and then press the F1 (s) button to confirm; or use arrow keys along with scroll wheel to complete the setting.</p>
Groups	<p>Press the Advance key on control panel. Select the F5 (Recorder) function. Press the F2 (Groups) button to enter setting of recorded group number. The setting on LCD is activated and appears in red font color. Use number pad to set the parameters directly and then press the F1 (Done) button to confirm; or use arrow keys along with scroll wheel to complete the setting.</p>
Channel	<p>Press the Advance key on control panel. Select the F5 (Recorder) function. Press the F3 (Channel) button to enter setting of recorded channel. F1 (CH1), F2 (CH2), F3 (CH3) are available for selection. The numbers of channel may vary by models.</p>
Memory	<p>Press the Advance key on control panel. Select the F5 (Recorder) function followed by pressing F4 (Memory) button to setting of recorded saving. Recorded data can be stored in internal memory or external USB Flash.</p>

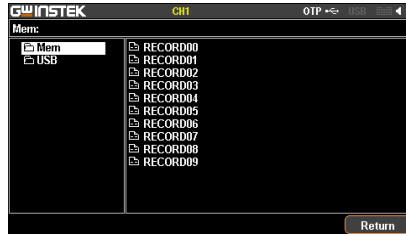

Internal Storage

1. Press right arrow button to enter the list of 10 groups. Rotate the scroll wheel (Encode) to select target file. Also rotate the scroll wheel (Encode) to enter the flash drive when necessary.



2. Press F3 (Save) button to save the temporary data into the corresponding file.
3. Press F4 (Recall) button to save the record data of file into the temporary storage for further saving into flash drive later.

Flash drive operation description

Type/**.CSV/ *.REC/New File/Select buttons appear when flash drive is selected.



 Note:

- Type is used to select *.CSV and *.REC file types.
- New File is used to create new file.
- Select is used to open the required file folder.

Operation ON/OFF

Press F5 (REC.On) button to enter live record function. REC appears on the status bar (the color of channel remains the original when single channel is enabled, whilst it turns to white when multiple channels are activated).

External I/O Control

Description	<p>The GPP series models provides user with a programmable external trigger port, which is used to dock certain functions control.</p>	
Function	<p>It can turn each Data Line (D0,D1,D2,D3,D4) into input signal respectively to have command of the following four functions:</p> <ol style="list-style-type: none"> 1. Control of channel On/Off 2. Control of Tracking mode 3. Toggle between PWR/Load modes 4. Toggle between CC/CV/CR modes under Load <p>The conditions listed below for output signal setting:</p> <ol style="list-style-type: none"> 1. Channel output On/Off 2. Beyond the setting of Voltage/Current/Power 	

Rear Pannel
Control Port

Up to 10 terminals within the control port; the upper 5 terminals can be set input/output functions, while the lower 5 are ground terminals. See diagram in right side for details (rear view).

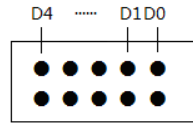

Schematic diagram
for control signal

The control circuit of each port is illustrated as the diagram below (D1 for example)

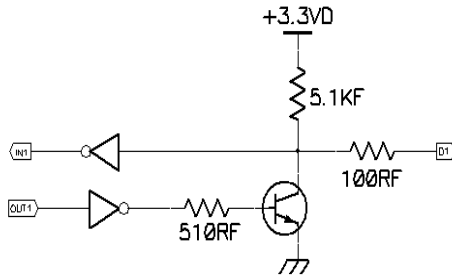

I/O port	Electrical characteristics	
Input	Low Level DC Voltage	$\leq 0.3V$
	High Level DC Voltage	$\leq 3.3V$
Output	Low Level DC Voltage	$\leq 0.3V$
	High Level Voltage	$\leq 3.3V$
	DC output Current	$\leq 0.6mA$

Key Function Description

Input/Output Mode:

Key	Function	Operation Result
F1	Data Line	Select object to be set from D0 to F4
F2	Enable	Set to Enable or Disable function of the port
F3	Mode	Set which mode to adopt: Input Mode or Output Mode
F4	Channel	Select corresponding channel: F1(CH1), F2 (CH2), F3 (CH3)
F5	More	
F6	Return	

F5 (More) under Input Mode setting:

Key	Function	Operation Result
F1	Type	Select trigger type: F1(RiseEdge), F2 (FallEdge), F3 (Hi-Level), F4 (Lo-Level), , F5(States Input) * "States Input" equivalent to edge trigger (RiseEdge + FallEdge)
F2	Response	Set result after trigger response: F1(Output) sets as ON, OFF or reverse Toggle F2 (PWR.Mode) sets channel as power mode F3 (Load Mode) set channel as load CV/CC/CR mode F4(Track Mode) sets tracking mode of CH1/CH2. This function will only work if channels CH1 and CH2 are selected simultaneously(only source mode),GPP-1326 does not have such function.
F3	Sensitivity	Set sensitivity of trigger: High/Middle/Low
F4		
F5		
F6	Return	

F5 (More) under Output Mode setting:

Key	Function	Operation Result
F1	Condition	Set response type: F1(Output), F2 (Voltage), F3 (Current), F4 (Power), F5 (Auto) ⚠ Note: F5 (<i>Auto</i>) triggers automatically only when voltage, current or power triggers meet at least one condition.
F2	Polarity	Set the polarity of output signal
F3,F4		
F5	State Out.	Enable or disable the state output
F6	Return	

Description

Operation	Press the System key on control panel. Select the F1 (Interface) function followed by pressing the F5 (Control I/O) button to enter the setting of external I/O.
	Press the F1 (Data Line) button. Select required data line from D0 through D4: F1(D0), F2(D1) , F3(D2) , F4(D3) , F5(D4).
	Press the F2 (Enable) button to set this terminal as input or output function. This button enables Enable or Disenable to be selected in turn.
	Press the F3 (Mode) button to set this terminal as input or output function. This button enables Input Mode or Output Mode to be selected in turn.
	Press the F4 (Channel) button to activate the Channel of this terminal:F1(CH1), F2(CH2), F3(CH3).
Key F5 (More)	After pressing the F3 (Mode) button, Trigger in and Trigger out will bring about different results individually. Refer to the table above for details.

F FILE OPERATION

Restore Factory Default Settings 93

Save/Recall

Description System provides user with 4 different files, each of which has 10 groups including parameter setting *.set, use record *.rec, sequence output *.seq and delay output *.dly.

 **Note:** Both file folder and name in flash drive are limited within 8 characters.

- Set file operation *.set**
1. Press the Memory button to enter the interface. Rotate the scroll wheel (Encode) to select file of either internal memory or flash drive.

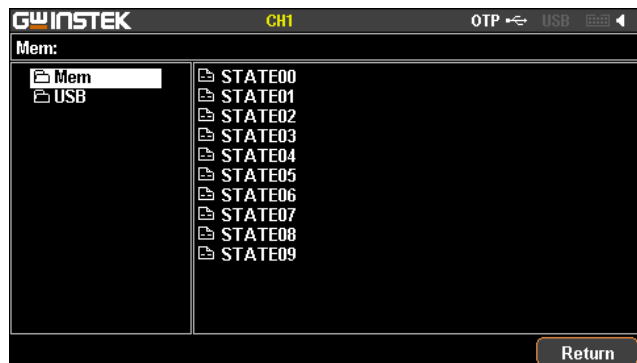

- Press the right arrow button to enter the file group. Rotate the scroll wheel (Encode) and stop at the file in need



- Press the F3 (Save) button to have the settings of current model saved into the corresponding file.
- Or press the F4 (Recall) button to recall the corresponding file, whose file name will be shown on the status bar.

Recorded file operation *.SEQ

Refer to page 63 for chapter of save and recall Sequence data.

⚠ Note: *.SEQ file can be edited in PC by the specified format (*.CSV or *.SEQ) and imported, via flash drive, into machine.

Recorded file operation *.DLY

Refer to page 74 for chapter of save and recall Delay data.

⚠ Note: *.DLY file can be edited in PC by the specified format (*.CSV or *.DLY) and imported, via flash drive, into machine.

Recorded
file
operation
*.REC

Refer to page 84 for chapter of Memory operation of Record.

⚠ Note: *.REC file can be edited in PC by the specified format (*.CSV or *.REC) and imported, via flash drive, into PC.

Power-on
setting

In the System Setting menu, the interface parameter settings area shows Power On. There are 2 settings to choose from, Last (the last shut down status) and Default (non-modifiable factory default setting).

To enter the function, press the System button to enter the interface followed by pressing the F2 (Power on) button.



Restore Factory Default Settings

Description There's a group of Default value, the non-modifiable factory default setting. User is able to restore Default or proceed to Preset operation from Power On under System.

Operation Press the System button to enter the interface followed by pressing either the F2 (Power On) or the F5 (Preset) button to select Default.

Default setting of each channel

Channel item	Parameter	Channel item	Parameter
Voltage	00.000V 5V(CH3)	Current	0.0000A
OVP	CH1/2: Off, 35V(3060) Off, 65V(6030) CH3: Off, 5.5V	OCP	CH1/2: Off, 6.5A(3060) Off, 3.5A(6030) CH3 usb port: On, 3.1A
Disp Type	Type1	Vset(Load)	1.500V
Model	PWR	Iset (Load)	0.000A
Tracking	Indep.	Rset(Load)	0050Ω

Default setting of system

System item	Parameter	System item	Parameter
Beeper	On	Subnet Mask	255.255.0.0
Backlight	High	HOST Name	GPP
Power On	Default		
Output Panel	Front		

S SYSTEM SETTINGS

System Information	95
System Settings	96
Firmware Upgrading	98
Description of Using Flash Drive	99

System Information

System Information The picture below shows complete system information. If the selected model is without ports (GPIB, LAN), the corresponding info will disappear.

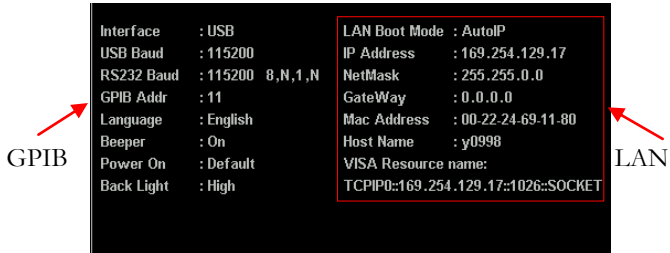

Check operation Press the System button on the panel to show the screen as above.

System Version	Model	View the device Model.
	Firmware	View the system software version.
	Serial Number	View the machine serial number.

Check operation Press the System button followed by pressing the F4 (Version) button to show the above system version window.

System Settings

Description	It can be used to perform system operations for machine.	
Setting information	Interface	Remote control and relevant data output setting
	Power On	Power on initial state setting
	Language	menu language setting
	BackLight	Adjust the LCD brightness.
	Beeper	Sets when the buzzer is turn on.
	Upgrade	Firmware upgrade
	Hardcopy	For Screenshot operation
	Preset	Restore to Factory Settings
	Output panel	Select front or rear output
Remote control setting	The System menu, press the F1 (Interface) button to select port in need. For more details, refer to page 101.	
Power on initial state setting	In the System menu, press the F2 (Power On) button to select required power on setting: Last (the last shut down setting) and Default (factory default setting).	
Menu language setting	The System menu, press the F3 (Setting) button followed by selecting the F1 (Language) to locate the F1 (English) button or the F2 (Chinese) button.	

Backlight brightness adjustment	In the System menu, press the F3 (Setting) button followed by selecting the F2 (Backlight) to adjust backlight brightness. There are three brightness levels: High, Middle, and Low. Select from pressing the F1 (Low) or F2 (Middle) or F3 (High) button.
Buzzer operation	In the System menu, press the F3 (Setting) button followed by selecting the F3 (Beeper) to turn on or turn off the buzzer beeper.
Firmware upgrade	In the System menu, press the F3 (Setting) button followed by selecting the F4 (Upgrade) button to upgrade the machine to the latest software version. For more details, refer to page 97.
Screenshot operation	In the System menu, press the F3 (Setting) button followed by selecting F5 (Hardcopy) to proceed to screenshot operation. For more details, refer to page 99.
Restore to Factory Settings	In the System menu, press the F5 (Preset) button to restore to the factory default setting. For more details, refer to page 93.
Select front or rear output	Double click system key, press F1 (front) key to select front port output or F2 (rear) key to select rear port output, refer to page 31.

Firmware Upgrading

When to Upgrade Firmware	When system is failure, request by customer GW Instek. When the system fails, firmware can requested by GW Instek customers.
--------------------------	--

Upgrade Requirement	Firmware file	Supplied by GW Instek
---------------------	---------------	-----------------------

Operation	<p>After plugging in flash drive, the corresponding symbol appears in the status bar.</p> <p>Press System button;</p> <p>Press F3 (Setting) button;</p> <p>Press F4 (Upgrade) button;</p> <p>Rotate the scroll wheel to select corresponding file;</p> <p>Press the F4 (Recall) button and start to upgrade;</p> <p>The procedure is done when the message, upgrading successful, shows up.</p>
-----------	---



Note

Flash drive only support USB2.0/USB3.0,FAT32 file system,16G MAX.

Description of Using Flash Drive

Description	It can be used when upgrading the software upgrades, screenshot operation and importing or exporting files. Flash drive only support USB2.0/USB3.0,FAT32 file system,16G MAX.
Operation	Insert flash driver into the USB Host port. Then the system identifies the flash driver and the indentification appears in the status bar.
Software Update	refer to page 97;
Screenshot operation	In the target interface, press System button > F3 (Setting) > F5 (Hardcopy) button and rotate the scroll wheel (Encode) to locate the target interface followed by pressing Enter key to save screenshot. A confirm voice will sound when successful.



The file format of screenshot is *.BMP and is saved in the root directory of flash drive by default.

Exporting the
Sequence data

The files of Sequence (*.SEQ), Recorder (*.REC), Delay (*.DLY), etc within machine can be, in addition to individual format, converted to *.CSV file format for easy check and edit in PC by user. For more details, refer to page 90.

REMOTE CONTROL

RS-232	104
USB	106
GPIB	108
LAN	110
Command Syntax	116
Command List	120
Measurement Instructions	120
Display Functions	120
Output Commands	120
Source and Load Commands	121
Status Commands	126
System Commands	127
System Related Commands	128
IEEE488.2 Common Commands	129
Command Details	130
Measurement Commands	130
Display Commands	132
Output Commands	134
Source and Load Commands	139
Status Commands	183
System Commands	190
System Related Commands	199
SCPI Status Registers SCPI	200
Event Registers	202

Enable Registers	202
Status Byte Register	202
Standard Event Register	204
Status Byte Register Commands.....	205
Standard Event Register Commands	206
Other Status Register Commands	208
Errors.....	209
Error Message.....	209
Command Errors	209

Connection Usage

This chapter describes how to set and enable port, as well as all the required preparations prior to operation.

Port type	The GPP series has 2 standard remote control ports (RS-232, USB), and 2 optional ports (GPIB, LAN).
Port selection	It is allowed to control the GPP series by only single remote control method once time. Before to use, it's required to select or confirm beforehand.
Operation	Press the System button followed by pressing the F1 (Interface) button to select the target port: F1 (RS-232), F2 (USB), F3 (GPIB), F4 (LAN). The available ports <code>Interface :USB</code> will appear on the LCD.
State	The selected port will appear in the status bar with font color in gray, for instance <code>USB</code> , whilst it will change to white color after successful commnad operation.

RS-232

Description	The GPP series models can be remotely controlled by RS-232 connection.
Interface	Rear panel RS-232 port 
Connection	<p>Under power-off state, connect RS-232 cable and select RS-232 port in the Interface. The message USB232 will appear gray in the status bar when connection, and turns to white color while the first command connects successfully.</p> <p>Panel control will be automatically under lock state when connection is successful.</p>
Parameter Setting	Press the System button followed by pressing the F1 (Interface) button to select the target port: F1 (RS-232). The setting of baud rate will appear automatically, please then choose desired setting.
Display	<p>The parameter information of RS-232 will appear on LCD. Refer to the description below:</p> <pre data-bbox="418 1082 796 1110">RS232 Baud :115200 8,N,1,N</pre> <p>8 --->data bit 8bit</p> <p>N --->no parity bit</p> <p>1 --->stop bit 1bit</p> <p>N --->no flow control bit</p>

Function check Perform the following query:

*IDN?

The unit will return the manufacturer, model, serial number and software version.

GW INSTEK, GPP-3060, SN: xxxxxxxx, Vx.xx

Disable Remote
Control Mode

- Send a remote command Local from the PC.
- Long-press the F6 (unlock) key on the front panel.



Warning: RS-232 is Not hot-plug device.
Please proceed to the connection procedure
under the power-off state.

USB

Description	GPP can be connected via USB using the USB Communications Device (CDC) class.
-------------	---

Interface	Rear panel USB device port.
-----------	-----------------------------

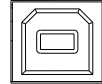

Installing the Driver	Install the USB driver provided by supplier in PC.
-----------------------	--

Select USB port in the Interface after connecting the USB cable. The message USB will appear gray in the status bar when connection, and turns to white color while the first command connects successfully.

The front panel keys are automatically locked when the connection is successful.

Parameter Setting	Press the System button followed by pressing the F1 (Interface) button to select the target port: F2 (USB). The setting of baud rate will appear automatically, please then choose desired setting.
-------------------	---

Display	The parameter information of USB will appear on LCD. Refer to the description below:
---------	--

USB Baud : 115200

115200----> transmission baud rate

Function Check

Perform the following query:

*IDN?

The unit will return the manufacturer, model, serial number and software version.

GW INSTRON, GPP-3060, SN: xxxxxxxxxx, Vx.xx

Disabling Remote Control Mode

- Send a remote command from the PC
 - Long-press the F6 (unlock) key on the front panel.
 - Unplug the USB cable from the rear panel.
-



Note

USB devices are hot-plug devices. You can directly remove the cable and exit.

GPIB

Description The communication data format, compatibility settings and GPIB address must all be configured before using GPIB remote control.

Interface Rear panel GPIB port. 

Connection Select GPIB port in the Interface after connecting the GPIB cable. The message GPIB will appear gray in the status bar when connection, and turns to white color while the first command connects successfully.

The front panel keys are automatically locked when the connection is successful.

Parameter Setting Press the System button followed by pressing the F1 (Interface) button to select the target port: F3 (GPIB). The setting of communication address will appear automatically. Input required address when the setting of GPIB Addr turn red color and press the F1 (Enter) button to confirm.

Display The address information of GPIB will appear on LCD. Refer to the description below:

GPIB Addr : 11

11----> GPIB address of the current unit

- Exiting from Remote Control Mode
- Send a remote command from the PC
 - Long-press the F6 (unlock) key on the front panel.

LAN

Description	When using the LAN port, the relevant parameters are supposed to be set earlier.
Connection	Select LAN port in the Interface after connecting the LAN cable. The message LAN will appear gray in the status bar when connection, and turns to white color while the first command connects successfully.
Set port	<p>The front panel keys are automatically locked when the connection is successful.</p> <p>A. Press the System button to enter the system interface followed by pressing the F1 (Interface) button to configure port parameter.</p> <p>B. Press the F4 (LAN) button to configure internet port parameter.</p>
Edit Host name	<p>A. Press the System button to enter the system interface followed by pressing the F1 (Interface) button to configure port parameter.</p> <p>B. Press the F4 (LAN) button to configure internet port parameter.</p> <p>C. Press the F1 (Config) button to configure relevant parameter.</p>

D. press the F4 (Host Name) button to manually input. The Name area will be activated and become red color after setting. The default first letter is A, and can be changed to other string by rotating scroll wheel Encoder (A, B...Z, a, b...z, 1, 2...9, 0, - in clockwise sequence). Press the F1 (Enter) button to confirm current string and automatically enter the next string input. Repeat the process above until completing a full name.

IP Mode	The IP address can be obtained by using either DHCP or Manual IP.
---------	---

Manual IP	<p>A. Press the System button to enter the system interface followed by pressing the F1 (Interface) button to configure port parameter.</p> <p>B. Press the F4 (LAN) button to configure internet port parameter.</p> <p>C. Press the F2 (Config) button to configure relevant parameter.</p> <p>D. Press the F3 (Manual) button to manually configure.</p> <p>E. press the F1 (IP Addr) button to manually input IP address. The set content will be activated to become red color. Input required data and confirm by pressing the F1 (Done) button. Press the F5 (Clear) button to clear and input again if error occurs.</p>
-----------	--

F. return to the Manual configuration menu and repeat manually configuring NetMask. Press the F2 (NetMask) button to manually input data. The set content will be activated to become red color. Input required data and confirm by pressing the F1 (Done) button. Press the F5 (Clear) button to clear and input again if error occurs.

G. return to the Manual configuration menu and repeat manually configuring GateWay. Press the F3 (GateWay) button to manually input data. The set content will be activated to become red color. Input required data and confirm by pressing the F1 (Done) button. Press the F5 (Clear) button to clear and input again if error occurs.

Parameter Settings:

IP Address: IP address range: 1.0.0.0 to 223.255.255.255 (excluding 127.nnn.nnn.nnn).

Subnet Mask: Subnet Mask Range: 1.0.0.0 to 255.255.255.255.

Gateway: Gateway range: 1.0.0.0 to 223.255.255.255 (excluding 127.nnn.nnn.nnn).

VISA Resource name :
TCPIP0::169.254.129.17::1026::SOCKET

DHCP

A. Press the System button to enter the system interface followed by pressing the F1 (Interface) button to configure port parameter.

B. Press the F4 (LAN) button to configure internet port parameter.

C. Press the F1 (Config) button to configure relevant parameter.

D. Press the F1 (DHCP) button. The unit will be assigned an IP address, subnet mask, the default gateway and other network parameters from the DHCP server. The corresponding parameters will be shown in the parameter area.

PC Operation

1. Enter the IP address into Microsoft Internet Explorer (IE). After entering the IP address you will be shown the Welcome screen which displays the instrument information. The page also provides three links: [Welcome Page](#), [Browser Web Control](#) and [View & Modify Configuration](#) (network settings).

Information about this Web-Enabled Instrument	
Instrument:	GPP-3060
Serial Number:	
Description:	Programmable DC Power Supply
Hostname:	GPP
Config Type:	DHCP
IP Address:	192.168.0.10
VISA TCP/IP Connect String:	TCP/IP: 192.168.0.10:1526:SOCKET
MAC Address:	00-22-24-69-11-80
Software Version:	V1.13
Auto-MEXX Capable:	Yes

Use the navigation bar on the left to access your GPP-3060 Programmable DC Power Supply and related information.

© GW INSTEK, Inc. 2017

2. Click on “Browser Web Control” to execute commands through the browser, as shown below.

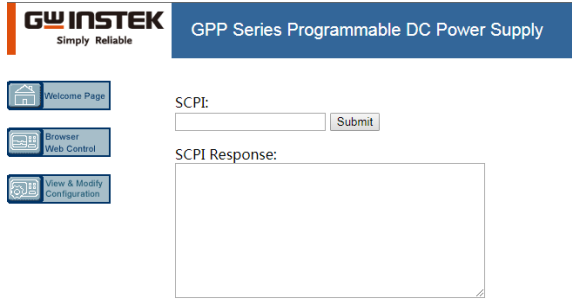

3. Press the “View & Modify Configuration” icon to enter the Modify Config menu, as shown below.

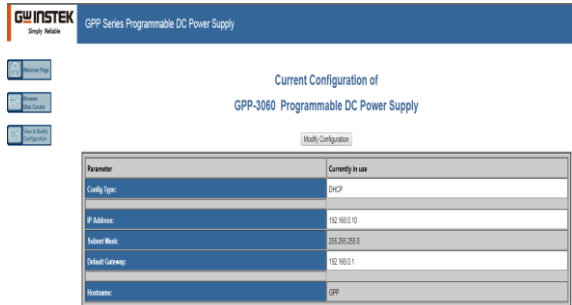

4. Click “Modify Config” to enter the network configuration setting menu, as shown below. Use the mouse to click on “Save and Restart” to change the remote settings for the GPP series.

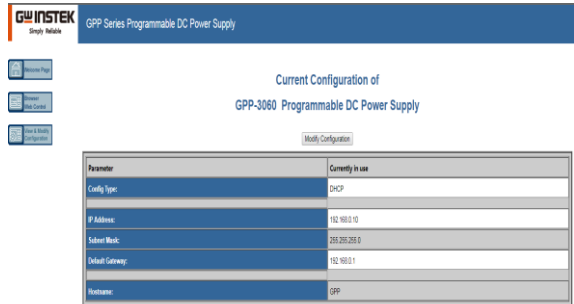

Click “Undo Edits” to cancel all the edited settings.

Click “Factory Defaults” to restore to the factory default settings.

Exiting from Remote Control Mode

- Send a remote command from the PC
- Long-press the F6 (unlock) key on the front panel.
- Unplug the USB cable from the rear panel.



Hot-swappable LAN devices can be directly disconnected to exit.

Command Syntax

The commands that are used with the GPP meet IEEE488.2 and SCPI standards.

SCPI Commands Overview SCPI

Command Format

SCPI is an ASCII based command language designed for test and measurement instruments. SCPI commands uses a hierarchical structure (tree system), and is divided into different subsystems. Each subsystem is defined by a different root keyword. Each command consists of a root keyword and one or more hierarchical key words separated by a colon ":" and followed by a parameter. There is always a space between the keywords and the parameters. Any commands followed by a question mark (?) are queries.

For Example:

```
:SYSTem:BEEPer:STATe {0|1|OFF|ON}
```

```
:SYSTem:BEEPer:STATe?
```

SYSTem is the root level keyword and BEEPer and STATe are the secondary and tertiary level keywords. All levels have a ":" separating each keyword. Parameters are enclosed in "{}".

The commands SYSTem:BEEPer:STATe has {0 | 1 | OFF | ON } as parameters. The parameters are separated with a space.

SYSTem:BEEPer:STATe? indicates that the command is a query.

In addition some commands have multiple parameters that are usually separated by a comma ",".

For example: :STATus:QUEue:ENABLE (-110:-222, -220).

Symbol Description

SCPI commands have the following conventional symbols. These symbols are not commands but are used to describe the command parameters.

1. Curly Brackets { }

Curly Bracket enclose command string parameters, for example:

{OFF | ON}

2. Vertical Bars |

Vertical bars are used to separate one or more optional parameters. Only one command can be selected. With the following two parameters, {ON | OFF} only ON or OFF can be selected.

3. Square Brackets []

The contents inside square brackets represent keywords or parameters that can be omitted when executing a command. For example: For the commands :OUTPut[:STATe] {ON | OFF}, [STATe] can be omitted.

4. Angle Brackets < >

The parameters in angle brackets must be substituted with a valid parameter. For example: For the command :DISPlay:CONTRast <brightness>, <brightness> must be use a numerical value instead such as, :DISPlay:CONTRast 1

Parameter Types

The commands have a number of different parameter categories. How the parameters are set depend on the parameter categories.

1. Boolean

Commands parameter that have to states "OFF" and "ON", for example, DISPLAY:FOCUS {ON | OFF}. "ON" will turn on the focus display function, while "OFF" will turn it off.

2. Consecutive Integers

Parameters that use consecutive integers, for example: For the command :DISPLAY:CONTRast <brightness>, <brightness> is an integer value with a range of 1~3.

3. Continuous Real Number

Parameter that must be a continuous real number can have any value within the effective range and accuracy. For example: The command CURRent {<current> | MINimum | MAXimum}, is used to set the current value for the current operating channel. <current> can be any value within the setting range of the current channel.

4. Discrete

For discrete parameters, only those values that are listed can be used. For example: The *RCL {0 | 1 | 2 | 3 | ... | 9} command can only use 0, 1, 2, 3, ..., 9.

5. ASCII Strings

ASCII string parameters must use a combination of ASCII characters in a string. For example: For the command: MODE <name>, <name> must be an ASCII string.

Command Abbreviations

The syntax for SCPI commands contains a combination of upper and lower case letters. The upper case letters in a command represent the short form of that command.

Commands are not case sensitive and can be used in both upper and lower case. Note, however, to use the short form of the command, only the capital letter part of the command can be used (no other abbreviation can be used). For example:

:MEASure:CURRent?

Can be abbreviated to:

:MEAS:CURR?

Command Terminators

When sending a command to the function generator, the command must be terminated with a <new line> character. The IEEE-4888 EOI can also be used as a <new line> character. A command can also be terminated using a carriage return + <new line> character. The command path will always be reset back to the root level after a command has been terminated.

Return values are terminated with 0x0A.

Command List

Measurement Instructions

:MEASure[1 2 3]:<function>?	Page 130
:MEASure[1 2 3]:ALL?	Page 130
:MEASure:<function>:ALL?	Page 130
VOUT<X>?	Page 131
IOUT<X>?	Page 131

Display Functions

:DISPlay:ENABle 	Page 132
:DISPlay:ENABle?	Page 132
:DISPlay:BRIGHtness <NRf>	Page 132
:DISPlay:BRIGHtness?	Page 132
:DISPlay:TYPE {1 2 4 5 6 7}	Page 133
:DISPlay:TYPE?	Page 133

Output Commands

:OUTPut[1 2 3][:STATe] 	Page 134
:OUTPut[1 2 3][:STATe]?	Page 134
:ALLOUTON	Page 134
:ALLOUTOFF	Page 134
OUT<Boolean>	Page 134
ROUTE:TERMinals {FRONt/REAR}	Page 135
ROUTE:TERMinals?	Page 135
:OUTPut[1 2 3]:OVP:STATe 	Page 135
:OUTPut[1 2 3]:OVP:STATe?	Page 135

:OUTPut[1 2 3]:OVP:TRIGger?	Page 136
:OUTPut[1 2]:OVP <value>	Page 136
:OUTPut[1 2 3]:OVP?	Page 136
:OUTPut[1 2 3]:OCP:STATe 	Page 137
:OUTPut[1 2 3]:OCP:STATe?	Page 137
:OUTPut[1 2 3]:OCP:TRIGger?	Page 137
:OUTPut[1 2]:OCP <value>	Page 137
:OUTPut[1 2 3]:OCP?	Page 138

Source and Load Commands

:SOURce[1 2]:CURRent <NRf>	Page 139
ISet<X>:<NR2>	Page 139
:SOURce[1 2]:CURRent?	Page 139
ISet<X>?	Page 139
:SOURce[1 2]:CURRent[:LIMit]:STATe?	Page 140
:SOURce[1 2]:VOLTage <NRf>	Page 140
VSet<X>:<NR2>	Page 140
:SOURce[1 2]:VOLTage?	Page 141
VSet<X>?	Page 141
:SOURce[1 2]:RESistor <NRf>	Page 141
:SOURce[1 2]:RESistor?	Page 141
:SOURce:CURRent:ALL?	Page 141
:SOURce:VOLTage:ALL?	Page 142
:OUTPut:SERies {ON OFF}[,FAST]	Page 142
:OUTPut:PARAllel {ON OFF}[,FAST]	Page 142
TRACk<NR1>	Page 143
:LOAD[1 2]:CV {ON OFF}[,FAST]	Page 143
:LOAD[1 2]:CC {ON OFF}[,FAST]	Page 143

:LOAD[1 2]:CR {ON OFF}	Page 144
:MODE[1 2]?	Page 144
:LOAD[1 2]: RESistor <Nrf>	Page 144
:LOAD[1 2]: RESistor?	Page 145
:LOAD:DISPlay {Low Middle High}	Page 145
:LOAD:DISPlay?	Page 145
:DELAy[1 2]:CYCLEs {N I}[,<value>]	Page 145
:DELAy[1 2]:CYCLEs?	Page 146
:DELAy[1 2]: ENDSState {ON OFF LAST}	Page 146
:DELAy[1 2]: ENDSState?	Page 146
:DELAy[1 2]:GROUPs <Nrf>	Page 146
:DELAy[1 2]:GROUPs?	Page 147
:DELAy[1 2]:PARAMeter <No>,{ON OFF},<time>	Page 147
:DELAy[1 2]:PARAMeter? <No>,<cecount>	Page 147
:DELAy[1 2]: RESTart	Page 148
:DELAy[1 2]:STARt <value>	Page 148
:DELAy[1 2]:STARt?	Page 149
:DELAy[1 2]::STATe] {ON OFF}	Page 149
:DELAy[1 2]::STATe]?	Page 149
:DELAy[1 2]:STATe:GENERate {01P 10P}	Page 149
:DELAy[1 2]:STATe:GENERate?	Page 150
:DELAy[1 2]:STOP {NONE <V >V =V <C >C =C <P >P =P}[,<value>]	Page 150
:DELAy[1 2]:STOP?	Page 150
:DELAy:SYNChronize {ON OFF}	Page 151
:DELAy[1 2]:TIME:GENERate {FIX INC DEC} [,<value0>[,<value1>]]	Page 151
:DELAy[1 2]:TIME:GENERate?	Page 152
:DELAy[1 2]:MEMory:SAVE {0,1,2,3,4,5,6,7,8,9}	Page 153

:DELAy[1 2]:MEMory:LOAD {0,1,2,3,4,5,6,7,8,9}	Page 153
:DELAy[1 2]:USB:SAVE <dest>	Page 153
:DELAy[1 2]:USB:LOAD <dest>	Page 154
:MONItor[1 2]:CURRent:CONDition {<C >C =C NONE}, {AND OR NONE}	Page 154
:MONItor[1 2]:CURRent:CONDition?	Page 155
:MONItor[1 2]:CURRent[:VALue] {<value> MINimum MAXimum}	Page 155
:MONItor[1 2]:CURRent[:VALue]?	Page 155
:MONItor[1 2]:POWER:CONDition {<P >P =P NONE}	Page 155
:MONItor[1 2]:POWER:CONDition?	Page 156
:MONItor[1 2]:POWER[:VALue] {<value> MINimum MAXimum}	Page 156
:MONItor[1 2]:POWER[:VALue]?	Page 156
:MONItor[1 2][:STATe] {ON OFF}	Page 157
:MONItor[1 2][:STATe]?	Page 157
:MONItor[1 2]:STOPway {OUTOFF ALARM BEEPER},{ON OFF}	Page 157
:MONItor[1 2]:STOPway?	Page 157
:MONItor[1 2]:VOLTage:CONDition {<V >V =V NONE},{AND OR NONE}	Page 158
:MONItor[1 2]:VOLTage:CONDition?	Page 158
:MONItor[1 2]:VOLTage[:VALue] {<value> MINimum MAXimum}	Page 158
:MONItor[1 2]:VOLTage[:VALue]?	Page 159
:RECOOrder[1 2]: PATH?	Page 159
:RECOOrder[1 2]:MEMory {0 1 2 3 4 5 6 7 8 9}	Page 159
:RECOOrder[1 2]: USB <dest>	Page 159
:RECOOrder:PERIOd <value>	Page 160

:RECOOrder:PERIOd?	Page 160
:RECOOrder[:STATe] {ON OFF}	Page 160
:RECOOrder[:STATe]?	Page 161
:RECOOrder[1 2]:GRouP's <value>	Page 160
:RECOOrder[1 2]:GRouP's?	Page 160
:RECOOrder[1 2]:ENABle {ON OFF}	Page 160
:RECOOrder[1 2]:ENABle?	Page 161
:SEQUence[1 2]:CYCLEs {N I}[,<value>]	Page 162
:SEQUence[1 2]:CYCLEs?	Page 162
:SEQUence[1 2]:ENDState {OFF LAST}	Page 163
:SEQUence[1 2]:ENDState?	Page 163
:SEQUence[1 2]:GRouP's <value>	Page 163
:SEQUence[1 2]:GRouP's?	Page 163
:SEQUence[1 2]:PARAMeter<No>,<volt>,<curr>,<time>	Page 164
:SEQUence[1 2]:PARAMeter? <No>,<count>	Page 164
:SEQUence[1 2]:REStArt	Page 165
:SEQUence[1 2]:StARt <value>	Page 165
:SEQUence[1 2]:StARt?	Page 166
:SEQUence[1 2][:STATe] {ON OFF}	Page 166
:SEQUence[1 2][:STATe]?	Page 166
:SEQUence: SYNChronize{ON OFF}	Page 167
:SEQUence[1 2]:TEMPlEt:CONStRuct	Page 167
:SEQUence[1 2]:TEMPlEt:FALLRate <value>	Page 167
:SEQUence[1 2]:TEMPlEt:FALLRate?	Page 167
:SEQUence[1 2]:TEMPlEt:INTErval <value>	Page 168
:SEQUence[1 2]:TEMPlEt:INTErval?	Page 168
:SEQUence[1 2]:TEMPlEt:INVErt {ON OFF}	Page 168
:SEQUence[1 2]:TEMPlEt:INVErt?	Page 168

:SEQUence[1 2]:TEMPlet:MAXValue {<value> MINimum MAXimum}	Page 169
:SEQUence[1 2]:TEMPlet:MAXValue?	Page 169
:SEQUence[1 2]:TEMPlet:MINValue {<value> MINimum MAXimum}	Page 169
:SEQUence[1 2]:TEMPlet:MINValue?	Page 170
:SEQUence[1 2]:TEMPlet:OBject {V C}	Page 170
:SEQUence[1 2]:TEMPlet:OBject?	Page 170
:SEQUence[1 2]:TEMPlet:POINTs <value>	Page 170
:SEQUence[1 2]:TEMPlet:POINTs?	Page 171
:SEQUence[1 2]:TEMPlet:RISERate <value>	Page 171
:SEQUence[1 2]:TEMPlet:RISERate?	Page 171
:SEQUence[1 2]:TEMPlet:SElect {SINE PULSE RAMP UP DN UPDN RISE FALL}	Page 171
:SEQUence[1 2]:TEMPlet:SElect?	Page 171
:SEQUence[1 2]:TEMPlet:SYMMetry <value>	Page 172
:SEQUence[1 2]:TEMPlet:SYMMetry?	Page 172
:SEQUence[1 2]:TEMPlet:WIDTh <value>	Page 172
:SEQUence[1 2]:TEMPlet:WIDTh?	Page 172
:SEQUence[1 2]:TEMPlet:STARt <value>	Page 172
:SEQUence[1 2]:TEMPlet:STARt?	Page 173
:SEQUence[1 2]:MEMory:SAVE {0,1,2,3,4,5,6,7,8,9}	Page 173
:SEQUence[1 2]:MEMory:LOAD {0,1,2,3,4,5,6,7,8,9}	Page 173
:SEQUence[1 2]:USB:SAVE <dest>	Page 174
:SEQUence[1 2]:USB:LOAD <dest>	Page 174
:TRIGger:IN[:ENABle] {D0 D1 D2 D3 D4},{ON OFF}	Page 174
:TRIGger:IN[:ENABle]? {D0 D1 D2 D3 D4}	Page 175
:TRIGger:IN:RESPonse {D0 D1 D2 D3 D4},{ON OFF TOGGLE POWER C V CC CR IND SER PAR }	Page 175

:TRIGger:IN:RESponse? {D0 D1 D2 D3 D4}	Page 177
:TRIGger:IN:SENSitivity {D0 D1 D2 D3 D4}, {LOW MID HIGH}	Page 177
:TRIGger:IN:SENSitivity? {D0 D1 D2 D3 D4}	Page 178
:TRIGger:IN:SOURce {D0 D1 D2 D3 D4},{CH1 CH2 CH3},{ON OFF}	Page 178
:TRIGger:IN:SOURce? {D0 D1 D2 D3 D4}	Page 178
:TRIGger:IN:TYPE {D0 D1 D2 D3 D4}, {RISE FALL HIGH LOW STATE }	Page 178
:TRIGger:IN:TYPE? {D0 D1 D2 D3 D4}	Page 179
:TRIGger:OUT:CONDition {D0 D1 D2 D3 D4},{OUTOFF OUTON >V <V =V >C <C =C >P <P =P AUTO} ,<value>	Page 179
:TRIGger:OUT:CONDition? {D0 D1 D2 D3 D4}	Page 181
:TRIGger:OUT[:ENABLE] {D0 D1 D2 D3 D4}, {ON OFF}	Page 181
:TRIGger:OUT[:ENABLE]? {D0 D1 D2 D3 D4}	Page 181
:TRIGger:OUT:POLARity {D0 D1 D2 D3 D4}, {POSitive NEGAtive}	Page 181
:TRIGger:OUT:POLARity? {D0 D1 D2 D3 D4}	Page 182
:TRIGger:OUT:SOURce {D0 D1 D2 D3 D4}, {CH1 CH2 CH3}	Page 182
:TRIGger:OUT:SOURce? {D0 D1 D2 D3 D4}	Page 182
:TRIGger:OUT:STATe [D0 D1 D2 D3 D4,] {ON OFF}	Page 183
:TRIGger:OUT:STATe? [D0 D1 D2 D3 D4]	Page 183

Status Commands

STATus?	Page 183
:STATus:PRESet	Page 184
:STATus:OPERation[:EVENT]?	Page 184

:STATus:OPERation:CONDition?	Page 184
:STATus:OPERation:ENABle <NRf>	Page 184
:STATus:OPERation:ENABle?	Page 184
:STATus:MEASurement[:EVENT]?	Page 185
:STATus:MEASurement:ENABle <NRf>	Page 185
:STATus:MEASurement:ENABle?	Page 186
:STATus:MEASurement:CONDition?	Page 186
:STATus:QUEStionable[:EVENT]?	Page 186
:STATus:QUEStionable:CONDition?	Page 186
:STATus:QUEStionable:ENABle <NRf>	Page 186
:STATus:QUEStionable:ENABle?	Page 187
:STATus:QUEue[:NEXT]?	Page 187
:STATus:QUEue:ENABle <list>	Page 187
:STATus:QUEue:ENABle?	Page 188
:STATus:QUEue:DISAble <list>	Page 188
:STATus:QUEue:DISAble?	Page 188
:STATus:QUEue:CLEAr	Page 188

System Commands

:SYSTem:VERSion?	Page 190
:SYSTem:ERRor?	Page 190
ERR?	Page 190
:SYSTem:CLEAr	Page 191
:SYSTem:POSetup <name>	Page 191
:SYSTem:POSetup?	Page 191
:SYSTem:COMMunicate:LAN:DHCP[:STATe] 	Page 191
:SYSTem:COMMunicate:LAN:DHCP[:STATe]?	Page 191
:SYSTem:COMMunicate:LAN:IPAdDress <IP address>	Page 192

:SYSTem:COMMunicate:LAN:IPADdress?	Page 192
:SYSTem:COMMunicate:LAN:SMASk <Mask>	Page 192
:SYSTem:COMMunicate:LAN:SMASk?	Page 193
:SYSTem:COMMunicate:LAN:GATEway <IP address>	Page 193
:SYSTem:COMMunicate:LAN:GATEway?	Page 193
:SYSTem:COMMunicate:LAN:MANualip[:STATe] 	Page 193
:SYSTem:COMMunicate:LAN:MANualip[:STATe]?	Page 194
:SYSTem:COMMunicate:LAN:APPLY	Page 194
:SYSTem:REMote	Page 194
REMOTE	Page 194
:SYSTem:BEEPer:STATe {0 1 OFF ON}	Page 194
BEEP<Boolean>	Page 195
:SYSTem:BEEPer:STATe?	Page 195
:SYSTem:LOCal	Page 195
LOCAL	Page 195
:SYSTem:INTerface [USB RS232 GPIB LAN]	Page 195
:SYSTem:LANGuage [CHINese ENGLISH]	Page 196
:SYSTem:LANGuage?	Page 196
:SYSTem:BAUDrate:USB [9600 19200 38400 57600 115200]	Page 196
:SYSTem:BAUDrate:USB?	Page 196
:SYSTem:BAUDrate:RS232 [9600 19200 38400 57600 115200]	Page 196
:SYSTem:BAUDrate:RS232?	Page 196
BAUD<NR1>	Page 197
HELP	Page 197

System Related Commands

*IDN?	Page 199
-------	----------

*RST	Page 199
*SAV <NRf>	Page 199
SAV<NR1>	Page 199
*RCL <NRf>	Page 200
RCL<NR1>	Page 200

IEEE488.2 Common Commands

*SRE <Enable Values>	Page 205
*SRE?	Page 205
*STB?	Page 206
*ESE <Enable Value>	Page 206
*ESE?	Page 206
*ESR?	Page 206
*CLS	Page 208
*OPC	Page 208
*OPC?	Page 208

Command Details

When using commands to select a specific channel, [1] stands for CH1, [2] stands for CH2. "1" can be omitted when you want to select CH1 as it is selected by default. However if you wish to select CH2, "2" must be selected.

Measurement Commands

Command	:MEASure[1 2 3] :<function>?
Function	Performs a "READ?" query on the specified measurement function.
Description	<function> CURRent[:DC]:Measures the current. VOLTage[:DC]:Measures the voltage. POWER[:DC]:Measures the power.

Example :MEASure2:CURRent?
 Reads back the CH2 current value.



Note

About CH3 , The query voltage will return the set value, current and power will return zero.

Command	:MEASure[1 2 3]:ALL?
Function	Query the all measurement functions.

Example :MEASure2:ALL?
 Reads back the CH2 voltage ,current and power value.



Note

CH3 will return: voltage setting,0,0.

Command	:MEASure:<function>:ALL?
Function	Query the specified measurement function in all channels.

Description < function >: VOLTage,CURRent,POWER

Example :MEASure:VOLTage:ALL?
 Reads back the all channels voltage value.

 Note About CH3 , The query voltage will return the set value, current and power will return zero.

Command VOUT<X>?
 Function Returns the actual output voltage.
 Description X 1= CH1, 2= CH2

Example VOUT1?
 Returns the CH1 output voltage.

 Note About CH3, The query voltage will return the set value.

Command IOU<X>?
 Function Returns the actual output current.
 Description X 1=CH1, 2=CH2

Example IOU1?
 Returns the CH1 output current.

 Note About CH3 , The query current will return zero.

Display Commands

Command :DISPlay:ENABle
 Function Turn the LCD display on or off.
 Description b 0/OFF: Turns the display off.
 1/ON: Turns the display on.

Example :DISPlay:ENABle ON
 Turns the LCD display on.

Command :DISPlay:ENABle?
 Function Queries the state of the display.
 Return 0/OFF: Display turned off.
 1/ON: Display turned on.

Example :DISPlay:ENABle?
 Returns the state of the display.

Command :DISPlay:BRIGhtness <NRf>
 Function Sets backlight display brightness.
 Description <NRf> Low
 Middle
 High

Example :DISPlay:BRIGhtness Low
 Sets the backlight to Low.

Command :DISPlay:BRIGhtness?
 Function Queries the brightness of the display.

Return	Low: The brightness is low, Middle: The brightness is low, High: The brightness is low.
Example	:DISPlay:BRIGhtness? Returns the brightness of the display.
Command	:DISPlay:TYPE {1 2 4 5 6 7}
Function	Sets the display screens. For details, see page 34.
Example	:DISPlay:TYPE 4 Sets the display screens of TYPE4.
Command	:DISPlay:TYPE?
Function	Queries the TYPE of display screens.
Return	1: The type of display is TYPE1, n: The others are similar to 1.
Example	:DISPlay:TYPE? Returns the TYPE of display screens.

Output Commands

Command :OUTPut[1 | 2 | 3][:STATe]
 Function Turns the output on or off.
 Description 0/OFF: Turn off the output
 1/ON: Turn on the output

Example :OUTPut1:STATe ON
 Turns on the output of CH1.

Command :OUTPut[1 | 2 | 3][:STATe]?
 Function Queries the output state.
 Return 0/OFF: The output is turned off.
 1/ON: The output is turned on.

Example :OUTPut1:STATe?
 Returns the output state of CH1.

Command :ALLOUTON
 Function Turns the channels output on.

Example :ALLOUTON
 Turns the channels output on.

Command :ALLOUTOFF
 Function Turns the all channels output off.

Example :ALLOUTOFF
 Turns the all channels output off.

Command OUT<Boolean>
 Function Turns the output on or off.

<Boolean> : 0= off, 1=on

Example	OUT1 Turns on the output.
Command	ROUTe:TERMinals {FRONt/REAR}
Function	Set the front or rear terminal output.
Example	ROUTe:TERMinals REAR Set output from rear terminal.
Command	ROUTe:TERMinals?
Function	Query front or rear terminal output.
Return	FRONt: Output from front terminal. REAR: Output from rear terminal.
Example	ROUTe:TERMinals?
Command	:OUTPut[1 2 3]:OVP:STATe
Function	Turns OVP protection on/off.
Description	 0/OFF:Turns OVP off. 1/ON:Turns OVP on.
Example	:OUTPut2:OVP:STATe ON Turn on OVP on CH2.
Command	:OUTPut[1 2 3]:OVP:STATe?
Function	Queries the status of the OVP function.
Return	0/OFF: OVP function is off. 1/ON: OVP function is on.

Example :OUTPut2:OVP:STATe?
Returns the status of the OVP function on CH2.

Command :OUTPut[1 | 2 | 3]:OVP:TRIGer?
Function Query whether the OVP protection function has been triggered.

Return 0/OFF: The channel OVP protection is not triggered.
1/ON: The channel OVP protection has been triggered.

Example :OUTPut2:OVP:TRIGer?
Return whether the OVP protection function of channel 2 has been triggered.

Command :OUTPut[1 | 2]:OVP <value>
Function Sets the OVP level.
Description <value> Refer to the specification sheet on page 200 for value.

Example :OUTPut2:OVP 10.5
Sets the OVP voltage to 10.5V for CH2.



Note

About CH3, The OVP value can not be set.

Command :OUTPut[1 | 2 | 3]:OVP?
Function Queries the OVP voltage level.

Example :OUTPut2:OVP?
Queries the OVP voltage level on CH2.



Note

About CH3, OVP query value is 5.5V.

Command	:OUTPut[1 2 3]:OCP:STATe
Function	Turns OCP protection on/off.
Description	 0/OFF:Turns OCP off. 1/ON:Turns OCP on.
<hr/>	
Example	:OUTPut2:OCP:STATe ON Turn on OCP on CH2.
Command	:OUTPut[1 2 3]:OCP:STATe?
Function	Queries the status of the OCP function.
Return	0/OFF: OCP function is off. 1/ON: OCP function is on.
<hr/>	
Example	:OUTPut2:OCP:STATe? Returns the status of the OCP function on CH2.
Command	:OUTPut[1 2 3]:OCP:TRIGer?
Function	Query whether the OCP protection function has been triggered.
Return	0/OFF: The channel OCP protection is not triggered. 1/ON: The channel OCP protection has been triggered.
<hr/>	
Example	:OUTPut2:OCP:TRIGer? Return whether the OCP protection function of channel 2 has been triggered.
Command	:OUTPut[1 2]:OCP <value>
Function	Sets the OCP level.
Description	<value> Refer to the specification sheet on page 200 for value.
<hr/>	

Example :OUTPut2:OCP 1.5
Sets the OCP voltage to 1.5A for CH2.

 Note The USB port, OCP value can not be set.

Command :OUTPut[1 | 2 | 3]:OCP?
Function Queries the OCP current level.

Example :OUTPut2:OCP?
Queries the OCP current level on CH2.

 Note The USB port , CH3 OCP query value is 3.10A.

Source and Load Commands

Command :SOURce[1 | 2]:CURRent <NRf>
 Function Sets the current level.
 Description <NRf> 0.0000-6.2000 (Refer to the specification sheet for MAX value).

Example :SOURce2:CURRent 1.0005
 Sets the current level to 1.0005A for CH2.

 Note About CH3, The current value can not be set.

Command ISET<X>:<NR2>
 Function Sets the current level.
 Description X : 1= CH1, 2= CH2
 <NR2>: Decimal number, range 0-6.200A.



Example ISET1:2.234
 Sets the CH1 output current to 2.234A.

 Note About CH3, The current value can not be set.

Command :SOURce[1 | 2]:CURRent?
 Description Queries the current limit level.

Example :SOURce2:CURRent?
 Queries the current limit level on CH2.

Command ISET<X>?
 Function Returns the output current setting.
 Description X : 1= CH1, 2= CH2

Example	ISET1? Returns the CH1 output current setting.
Command	:SOURce[1 2]:CURRent[:LIMit]:STATe?
Function	Queries the current limit state.
Return	0: The current limit has not been reached. 1:The current limit has been reached.
Example	:SOURce2:CURRent:STATe? Return the current limit state of CH2.
 Note	At output off or Load Mode,The return value of is 0.
Command	:SOURce[1 2]:VOLTage < NRf >
Function	Sets the output voltage amplitude.
Description	<NRf> 0.000-MAX
Example	:SOURce2:VOLTage 5.321 Sets the output voltage to 5.321V for CH2.
 Note	About CH3, If the settings are not 1.8V/ 2.5V/3.3V or 5V, the existing output will not be affected and errors message will occur, Please refer to ":SYSTem:ERRor?" .
Command	VSET<X>:<NR2>
Function	Sets the Voltage level.
Description	X : 1= CH1, 2= CH2 <NR2>: Decimal number, range 0-32.000V.
Example	VSET1:20.345 Sets the CH1 voltage to 20.345V.

Command	:SOURce[1 2]:VOLTage?
Function	Queries the output voltage setting.
Example	:SOURce2:VOLTage? Queries the output voltage setting on CH2.
Command	VSET<X>?
Function	Returns the output voltage setting.
Description	X : 1= CH1, 2= CH2
Example	VSET1? Returns the CH1 output voltage setting.
Command	:SOURce[1 2]:RESistor < NRf >
Function	Set the resistor value.
Description	NRF 1-1000
Example	:SOURce2:RESistor 1000 Set the resistor value as 1000Ω for CH2.
Command	:SOURce[1 2]:RESistor?
Function	Queries the setting resistor value.
Example	:SOURce2:RESistor? Queries the setting resistor value and returns the readback value for CH2.
Command	:SOURce:CURRent:ALL?
Function	Queries the setting current value in all channels.

Example :SOURce:CURRent:ALL?
 Queries the setting current value and returns the readback value for all channels.



Note

About CH3, current value will returns 5.0000A.

Command :SOURce:VOLTage:ALL?

Function Queries the setting voltage value in all channnels.

Example :SOURce:VOLTage:ALL?

Queries the setting voltage t value and returns the readback value for all channels.

Command :OUTPut:SERies {ON | OFF}[,FAST]

Function Sets CH1/CH2 as tracking series mode.

Description [FAST]: In order to protect the function switching device" relay", it is necessary to wait until the voltage and current drop to zero under normal conditions. When FAST is enabled, this factor will not be considered, but it is easy to damage the "relay", so it is recommended to use it with caution.

Example :OUTPut:SERies ON

Sets CH1/CH2 as Tracking series mode.

Command :OUTPut:PARAllel {ON | OFF}[,FAST]

Function Sets CH1/CH2 as tracking parallel mode.

Description [FAST]: In order to protect the function switching device" relay", it is necessary to wait until the voltage and current drop to zero under normal conditions. When FAST is enabled, this factor will not be considered, but it is easy to damage the "relay", so it is recommended to use it with caution.

Example :OUTPut:PARAllel ON
Sets CH1/CH2 as tracking parallel mode.

Command TRACK<NR1>

Function Selects the operation mode: independent, tracking series, or tracking parallel. Series-parallel mode is not supported under LOAD.
NR1 0: Independent, 1: Series, 2: Parallel

Example TRACK0
Selects the independent mode.

Command :LOAD[1 | 2]:CV {ON | OFF}[FAST]

Function Sets CH1/CH2 as Load CV mode. Automatically switch to power mode after closing LOAD mode.

Description [FAST]: In order to protect the function switching device" relay", it is necessary to wait until the voltage and current drop to zero under normal conditions. When FAST is enabled, this factor will not be considered, but it is easy to damage the "relay", so it is recommended to use it with caution.

Example :LOAD2:CV ON
Sets CH2 as Load CV mode.

Command :LOAD[1 | 2]:CC {ON | OFF}[FAST]

Function Sets CH1/CH2 as Load CC mode.

Description [FAST]: In order to protect the function switching device" relay", it is necessary to wait until the voltage and current drop to zero under normal conditions. When FAST is enabled, this factor will not be considered, but it is easy to damage the "relay", so it is recommended to use it with caution.

Example :LOAD2:CC ON
Sets CH2 as Load CC mode.

Command :LOAD[1 | 2]:CR {ON | OFF}
Function Sets CH1/CH2 as Load CR mode.

Example :LOAD2:CR ON
Sets CH2 as Load CR mode.

Command :MODE[1 | 2]?
Function Queries CH1 or CH2 work mode.
6 modes below:
SERies, PARAllel, INDEpendent,
CV Load, CC Load, CR Load.

Example :MODE1?
Queries CH1 work mode.

Command :LOAD[1 | 2]:RESistor <NRf>
Function Sets the Load CR level.
Description <NRf> 1-1000

Example :LOAD2:RESistor 100
Sets the Load CR level to 100Ω for CH2.

Command	:LOAD[1 2]:RESistor?
Function	Queries the Load CR level.
Description	<NRf> 1-1000
Example	:LOAD2:RESistor? Return the Load CR level for CH2.
Command	:LOAD:DISPlay {Low Middle High}
Function	In load mode, set the minimum voltage value that can be displayed. The factory default is high. Below this value, it will display "--.----".
Description	Low: 0.5V; Middle: 0.75V; High:1V
Example	:LOAD:DISPlay Low In load mode, the minimum voltage value that can be displayed is 0.5V.
Command	:LOAD:DISPlay?
Function	Query the minimum voltage value that can be displayed in load mode.
Example	:LOAD:DISPlay? In load mode, query the minimum voltage value that can be displayed. The return variables are low, 0.5V; middle, 0.75V; high, 1V.
Command	:DELAy[1 2]:CYCLEs {N I}[,<value>]
Function	Sets the cycle number of Delay.
Description	<value> 1-99999 I represents an infinite loop. N represents a finite loop. The cycle number is set by parameter <value>.

Example	:DELAy2:CYCLEs N,100 Sets the cycle number of Delay as 100 for CH2.
Command	:DELAy[1 2]:CYCLEs?
Function	Queries the cycle number of Delay.

Example	:DELAy2:CYCLEs? Return to I or N, <value> for CH2 (For example: N,100).
Command	:DELAy[1 2]:ENDState {ON OFF LAST}
Function	Sets the termination state of Delay.
Description	ON OFF LAST ON: output enabled. OFF: output disabled. LAST: stay at the last group of output state.

Example	:DELAy2:ENDState OFF Sets the termination state of Delay as output disabled for CH2.
Command	:DELAy[1 2]:ENDState?
Function	Queries the termination state of Delay.
Description	ON OFF LAST ON: output enabled OFF: output disabled LAST: stay at the last group of output state.

Example	:DELAy2:ENDState? Return the termination state of Delay for CH2.
Command	:DELAy[1 2]:GROUPs <NRf>

Function	Sets the output number of Delay.
Description	<Nrf> 1 - 2048
Example	:DELAy2:GROUPs 100 Sets the output number of Delay as 100 for CH2.
Command	:DELAy[1 2]:GROUPs?
Function	Queries the output number of Delay.
Example	:DELAy2:GROUPs? Return the output number of Delay for CH2.
Command	:DELAy[1 2]:PARAMeter <No>,{ON OFF},<time>
Function	Sets the delay parameter of Delay.
Description	<No> 0-2047 Sets the serial number of delay parameter. Integer 0-2047. {ON OFF} The output state of the group. <time> 1s-300s The delay duration of the group. Integer 1s-300s.
Example	:DELAy2:PARAMeter 1,ON,10 Sets the delay parameter of Delay as the 1st group, output ON, delay 10s for CH2.
Command	:DELAy[1 2]:PARAMeter? <No>[,<count>]

Function	<p>Queries the delay parameter of the specified groups of Delay. Returns to a string initiating from #. Data head is to describe data length information starting from #. For example, ##900000017, the later 9 digits (00000017) following the initial 9 indicate length of data flow (17 bytes).</p> <p>The format of delay parameter of each group is "serial number, output state, delay duration", and parameter of each group is divided by semicolon";".</p> <p>For example: "2, OFF, 3;3, ON,1;" representing the delay parameters of 2 groups; the serial number of delay parameter of the 1st group is 2, output state is OFF,delay time is 3S;the 2nd group is 3, output state is ON,delay time is 1S.</p>
Description	<No> 0 - 2047 Sets the serial number of the delay parameter. Integer 0 - 2047.
Example	<p>:DELAy2:PARAMeter? 2,2</p> <p>Return the delay parameter of 2 groups of Delay for CH2. From the second group.</p>
Command	:DELAy[1 2]:REStart
Function	Start output with the first setting.
Example	<p>:DELAy2:REStart</p> <p>Sets the CH2 output with the first delay setting.</p>
Command	:DELAy[1 2]:StARt <value>
Function	<p>Sets the sequence number for initial execution.</p> <p><value>: Integer 0 - 2047.</p>
Example	<p>:DELAy2:StARt 10</p> <p>Sets the CH2 sequence output to start from the group 10.</p>

Command	:DELAy[1 2]:START?
Function	Queries the sequence number for initial execution of the channel delay output.
Example	:DELAy2:START? Returns the initial sequence number of CH2 sequence output.
Command	:DELAy[1 2][:STATe] {ON OFF}
Function	Enable or disable the delay output function of the active channel.
Description	{ON OFF} Output state of the group.
Example	:DELAy2 ON Enable the delay output function for CH2.
Command	:DELAy[1 2] [:STATe]?
Function	Queries whether the output function of Delay has been enabled or disabled.
Example	:DELAy2:STATe? Return whether the output function of Delay has been enabled or disabled for CH2.
Command	:DELAy[1 2]:STATe:GENERate {01P 10P}
Function	Selects the used pattern of the automatically generated state.
Description	01P 10P 10P: the automatically generated state will repeat by the sequence of Off and the On. The automatically generated state will repeat by the sequence of On and the Off.

Example	:DELAy2:STATe:GENE 01P The automatically generated state will repeat by the sequence of Off and the On for CH2.
Command	:DELAy[1 2]:STATe: GENERate?
Function	Queries the currently used pattern of the automatically generated state.
Example	:DELAy2:STATe:GENE? Queries the currently used pattern of the automatically generated state for CH2.
Command	:DELAy[1 2]:STOP {NONE <V >V =V <C >C =C <P >P =P}[,<v alue>]
Function	Sets the stop condition of delay.
Description	NONE: Sets stop condition type as "NONE". <V, >V, =V: Sets stop condition type as "<voltage" ">voltage" "=voltage". <C, >C, =C: Sets stop condition type as "<current" ">current" "=current". <P, >P, =P: Sets stop condition type as "<power" ">power" "=power". <value> It is used to set voltage, current or power value of stop condition, which range from 0 to the maximum voltage/current/power value of the active channel.
Example	:DELAy2:STOP >V,8 Sets the stop condition of delay as >8V for CH2.
Command	:DELAy[1 2]:STOP?
Function	Queries the stop condition of the current delay.

Example	:DELAy2:STOP? Queries the current stop condition, back to NONE or stop condition value.
Command	:DELAy:SYNChronize {ON OFF}
Function	When both CH1 and CH2 are Delay on, turn on or off the delay synchronization between them.
Example	:DELAy:SYNChronize ON turn on the delay synchronization of CH1 and CH2.
Command	:DELAy[1 2]:TIME:GENERate {FIX INC DEC}[,<value0>[,<value1>]]
Function	Sets the method of automatically generated time and the corresponding parameter of delay.

Description	<p><value0> The duration of "ON" state.</p> <p><value1> The duration of "OFF" state.</p> <p>FIX (fixed time) sets <value0> and <value1> time, which range from 1s to 300s. The default setting of delay time is enabled when only a time parameter is specified.</p> <p>Constant duration will be generated by the pattern of either monotonous increase or monotonous decrease when INC (monotonous increase) or DEC (monotonous decrease) is set. Starting from the base time, it gradually increases or decreases by steps and further generates duration. Base time (<value0>) and step value (<value1>) are available for setting, the mechanical relation of both of which is base time + output group number * step value ≤300s. The available range of setting value for <value0> is from 1s to (300s-output group number * step value). The available range of setting value for <value1> is from 1s- int{(300s-base time/output group number)}. The default duration is base time when only a time parameter is specified.</p>
Example	<pre>:DELAy2:TIME:GENE INC,3,5</pre> <p>Sets the CH2 method of automatically generated time for delay as monotonous increase, base time as 3s, step value as 5s.</p>
Command	<pre>:DELAy[1 2]:TIME:GENERate?</pre>
Function	<p>Queries the method of automatically generated time for delay and the corresponding parameter.</p>

Example	:DELAy2:TIME:GENE? Queries the CH2 method of automatically generated time for delay and the corresponding parameter. Return a string with format consisting of the method of automatically generated time, <value0>,<value1>.
Command	:DELAy[1 2]:MEMory:SAVE {0 1 2 3 4 5 6 7 8 9}
Function	Saves the delayed file to the designated location of internal storage.
Parameter	{0 1 2 3 4 5 6 7 8 9} represent the storage locations of 10 delayed files within the internal storage individually.
<hr/>	
Example	:DELAy2:MEMory:SAVE 1 Saves the CH2 delayed file to the DELAY01 of internal storage.
Command	:DELAy[1 2]:MEMory:LOAD {0 1 2 3 4 5 6 7 8 9}
Function	Recalls the delayed file saved in the designated location from internal storage.
Parameter	{0 1 2 3 4 5 6 7 8 9} represent the locations of storage of 10 delayed files within the internal storage individually.
<hr/>	
Example	:DELAy2:MEMory:LOAD 1 Recalls the delayed file of DELAY01 saved in the internal storage.
Command	:DELAy[1 2]:USB:SAVE <dest>
Function	Saves the delayed file to the designated location of external storage.

Parameter <dest> indicates the designated location of external storage with file format in either usb:\<name>.CSV or usb:\<name>.DLY. The file name spans up to the max. 8 alphanumeric characters. .CSV/.DLY represents the suffix of file name. Storage location can not be designated when delay function is enabled.

Example :DELAy2:USB:SAVE USB:\R001.CSV
Saves the CH2 delayed file, by the name of "R001.CSV", to the external storage.

Command :DELAy[1 | 2]:USB:LOAD <dest>

Function Recalls the delayed file saved in the designated location from external storage.

Parameter <dest> indicates the designated location of external storage.

Example :DELAy2:USB:LOAD USB:\R001.CSV
Recalls the CH2 delayed file, R001.CSV, saved in the external storage.

Command :MONItor[1 | 2]:CURRent:CONDition {<C | >C | =C | NONE},{AND | OR | NONE}

Function Sets the current monitor condition for monitor (current channel).

Description {<C | >C | NONE} Sets the current monitor condition as "<<C">(<current), ">C">(>current), "=C" (=current) or "NONE" (current not monitored).

{AND | OR | NONE} Practical monitor condition is the logical composition of voltage, current and power. , "AND" (and), "OR" (or), "NONE" (none-logical pattern).

Example :MONItor2:CURRent:CONDition <C,AND
 Sets the CH2current monitor condition for monitor as <current, and the logical pattern as “and”.

Command :MONItor[1 | 2]:CURRent:CONDition?
Function Queries the current monitor condition for monitor (active channel).

Example :MONItor2:CURRent:CONDition?
 Queries the CH2 current monitor condition for monitor. Returns to the current monitor condition and logical pattern.

Command :MONItor[1 | 2]:CURRent[:VALue]{<value> | MINi
 mum | MAXimum}

Function Queries the current monitor value for monitor (active channel).

Description <value> The range available is from 0 to the maximum current value of active channel.

Example :MONItor2:CURRent 2
 Sets CH2current monitor value for monitor as 2A.

Command :MONItor[1 | 2]:CURRent[:VALue]?
Function Queries the current monitor value for current monitor (active channel).

Example :MONItor2:CURRent?
 Queries the CH2 current monitor value for current monitor. Returns to the current monitor value of current monitor.

Command :MONItor[1 | 2]:POWER:CONDition
 {<P | >P | |=P | NONE}

Function	Sets the power monitor condition for monitor (active channel).
Description	{<P >P NONE} Sets power monitor condition as “ <P” (<power), “ >P” (>power) , “=P” (=power) or “NONE” (none-monitored power).
Example	:MONItor2:POWER:CONDition <P Sets the CH2 power monitor condition of monitor as <power>.
Command	:MONItor[1 2]:POWER:CONDition?
Function	Queries the power monitor condition of current monitor.
Example	:MONItor2:POWER:COND? Queries the CH2 power monitor condition of current monitor.
Command	:MONItor[1 2]:POWER[:VALue] {<value> MINimum MAXimum}
Function	Sets the power monitor value for monitor (active channel).
Description	<value> ranges from 0 to the maximum power value of the active channel.
Example	:MONItor2:POWER 20 Sets the CH2 power monitor value for monitor as 20W.
Command	:MONItor[1 2]:POWER[:VALue]?
Function	Sets the power monitor value for monitor (active channel).
Example	:MONItor2:POWER? Queries the CH2 power monitor value for current monitor.

Command	:MONItor[1 2][:STATe] {ON OFF}
Function	Enable or disable monitor (active channel).
<hr/>	
Example	:MONItor2 ON Enable monitor for CH2.
Command	:MONItor[1 2][:STATe]?
Function	Queries whether the current monitor is On or Off (active channel).
<hr/>	
Example	:MONItor2? Queries whether the current monitor is On or Off of CH2. Returns to ON or OFF.
Command	:MONItor[1 2]:STOPway {OUTOFF ALARM BEEPER},{ON OFF}
Function	Sets the stop method of monitor (active channel).
Description	{OUTOFF ALARM BEEPER} Disable output by set stop method (OUTOFF), warning (ALARM) or beep (BEEPER).
<hr/>	
Example	:MONItor2:STOPway ALARM,ON Enable stop method of “warning” for CH2.
Command	:MONItor[1 2]:STOPway?
Function	Queries the stop method for current monitor (active channel).
<hr/>	
Example	:MONItor2:STOPway? Queries the CH2 stop method state of current monitor. Returns to the on & off state of the 3 stop methods.

Command	:MONItor[1 2]:VOLTage:CONDition{<V >V =V NONE},{AND OR NONE}
Function	Queries the voltage monitor condition of monitor (active channel).
Description	{<V >V =V NONE} Sets voltage monitor condition as “ <V ” (<voltage), “ >V ” (>voltage), “ =V ” (=voltage) or “ NONE ” (none-monitored voltage). {AND OR NONE} Practical monitor condition is the logical composition of voltage, current and power. , “ AND ” (and), “ OR ” (or), “ NONE ” (non-logical pattern) .
Example	:MONItor2:VOLTage:CONDition <V,AND Sets the CH2 voltage monitor condition of monitor (active channel) as “ <voltage,and ” .
Command	:MONItor[1 2]:VOLTage:CONDition?
Function	Queries the voltage monitor condition for the current monitor (active channel).
Example	:MONItor2:VOLTage:CONDition? Queries the CH2 voltage monitor condition for the current monitor.
Command	:MONItor[1 2]:VOLTage[:VALue]{<value> MINi mum MAXimum}
Function	Sets the voltage monitor value of monitor (active channel).
Description	<value> ranges from 0 to the maximum voltage value of the active channel.
Example	:MONItor2:VOLTage 5 Sets the CH2 voltage monitor value of monitor as 5V (active channel).

Command	:MONItor[1 2]:VOLTag[:VALue]?
Function	Queries the voltage monitor value of monitor (active channel).
Example	:MONItor2:VOLTag? Queries the CH2voltage monitor value for the current monitor.
Command	:RECOOrder[1 2]:PATH?
Function	Queries the save location of recorded file.
Example	:RECOOrder2:PATH? Queries the save location of recorded file for CH2.
Command	:RECOOrder[1 2]:MEMOry{0 1 2 3 4 5 6 7 8 9}
Function	Save the recorded file to the internal storage with specified saving location.
Description	{0 1 2 3 4 5 6 7 8 9} represent individually 10 saving locations of recorded file within internal storage.
Example	:RECOOrder2:MEMOry 5 Save the CH2 recorded file to the saving location of recorded file within the internal storage 5.
Command	:RECOOrder[1 2]:USB <dest>
Function	Save the recorded file to the specified location within the external storage.
Description	<dest> represents the specified location within the external storage with specific formate usb:\<name>.CSV. The length is limited within 8 characters. Filename comes with .CSV in the end of surffix, which can be omitted.

Example	<p>:RECOder2:USB usb:\R001.CSV</p> <p>Save the CH2 recorded file with specified name "R001.CSV" to the external storage. To set record period and saving location is Not permitted when recorder is enabled. Therefore, preset required saving location prior to enabling recorder. Instrument will automatically save recorded file with specified name to the specified saving location when recorder is disabled.</p>
Command	:RECOder:PERIOd <value>
Function	Sets the record period of recorder.
Description	<value> ranges from 1s to 300s. Instrument samples and saves output intervals of all channels when recorder is enabled.
Example	<p>:RECOder:PERIOd 5</p> <p>Sets the recorded period of recorder as 5s.</p>
Command	:RECOder:PERIOd?
Function	Sets the recorded period of recorder.
Example	<p>:RECOder:PERIOd?</p> <p>Queries the recorded period for the current recorder. Returns to integer between 1 to 300.</p>
Command	:RECOder [:STATe] {ON OFF}

Function	<p>Enable or disable recorder.</p> <p>When recorder is enabled, it is Not allowed to set record period and saving location and instrument will sample and save output of each channel based on the interval of currently set recorded period.</p> <p>Make sure output of each channel is enabled during recording process. For those disabled output channels, the corresponding record data turn to 0 overall. When recorder is disabled, recording process terminates and instrument will automatically save recorded file to the currently set saving location.</p>
Example	<p>:RECOOrder ON</p> <p>Enable recorder.</p>
Command	:RECOOrder [:STATE]?
Function	Queries the current recorder state.
Return	<p>ON: Recorder is Enable.</p> <p>OFF: Recorder is Disable.</p>
Example	<p>:RECOOrder?</p> <p>Queries the state of recorder. Returns to ON or OFF.</p>
Command	:RECOOrder:GROUPs <value>
Function	Sets the group number of channel recorder.
Example	<p>:RECOOrder2:GROUPs 100</p> <p>Sets the group number as 100 for channel recorder.</p>
Command	:RECOOrder[1 2]:GROUPs?
Function	Queries the group number of channel recorder.

Example	:RECOOrder2:GROUPs? Returns the group number of CH2 recorder.
Command	:RECOOrder[1 2]:ENABLE {ON OFF}
Function	Sets the channel recorder ON or OFF.
Example	:RECOOrder2:ENABLE ON Enables CH2 recorder.
Command	:RECOOrder[1 2]:ENABLE?
Function	Queries the state of channel recorder.
Return	ON: Recorder is Enable. OFF: Recorder is Disable.
Example	:RECOOrder2:ENABLE? Returns the state of CH2 recorder, ON or OFF.
Command	:SEQUence[1 2]:CYCLEs {N I}[,<value>]
Function	Sets the cycle number of sequence.
Description	{N I} Sets cycle number as infinite (I) or specified value (N, <value>).
Example	:SEQUence2:CYCLEs N,20 Sets the cycle number of sequence as 20.
Command	:SEQUence[1 2]:CYCLEs?
Function	Queries the cycle number of the sequence.
Example	:SEQUence2:CYCLEs? Queries the cycle number of the sequence, Returns to I or N, <value>.

Command :SEQUence[1 | 2]:ENDState {OFF | LAST}

Function Sets terminate state of sequence.

Description {OFF | LAST} Output disabled (OFF): instrument automatically disable output when output is complete. The last group (LAST): instrument stays at the output state of the last group when output is complete.

Example :SEQUence2:ENDState LAST

Sets the terminate state of sequence as “the last group”.

Command :SEQUence[1 | 2]:ENDState?

Function Queries the terminate state of the sequence. See previous instruction.

Example :SEQUence2:ENDState?

Queries the CH2terminate state of the sequence. Returns to OFF or LAST.

Command :SEQUence[1 | 2]:GROUPs <value>

Function Sets the output group number of sequence.

Description <value> the definition of output group number is that the default voltage/current group number of power output from each cycle ranges from 1 to 2048. All group number of sequence = output group number*cycle number. Power will terminate timer function after completing outputs of all group numbers.

Example :SEQUence2:GROUPs 25

Sets the CH2 output group number of sequence as 25.

Command :SEQUence[1 | 2]:GROUPs?

Function	Queries the output group number of the sequence.
Example	:SEQUence2:GROUPs? Queries the CH2 output group number of the sequence. Returns to an integer between 1 to 2048.
Command	:SEQUence[1 2]:PARAMeter<No>,<volt>,<curr>,<time>
Function	Sets the parameter of the specified group.
Description	<No > is the serial number of sequence parameter of the specified group, integer, 0 to 2047. <volt> is the voltage of sequence parameter of the group. Unit is V, number, voltage range of the active channel. <curr> is the current of sequence parameter of the group. Unit is A, number, current range of the active channel. <time> is the time of sequence parameter of the group. Unit is s, number, 1s to 300s.
Example	:SEQUence2:PARAMeter 1,8,1,10 Sets the CH2 sequence parameter of the 1st group as 8V,1A,10s.
Command	:SEQUence[1 2]:PARAMeter? <No>,< count>

Function	<p>Queries the specified several groups of sequence parameter.</p> <p>Returns to a string initiating from #. Data head is to describe data length information starting from #. For example, ##900000037, the later 9 digits (00000037) following the initial 9 indicate length of data flow (37 bytes).</p> <p>The format of sequence parameter of each group is "serial number, voltage, current, timer time", and parameter of each group is divided by semicolon";". For example: 1,8.000,1.0000,10;2,6.000,1.0000,10; represents sequence parameters for 2 groups; the serial number of sequence parameter for 1st group is 1with voltage 8.000V, current 1.0000A and timer time 10s. The serial number of sequence parameter for 2nd group is 2with voltage 6.000V, current 1.0000A and timer time 10s.</p>
Description	<p><No>: The serial number 0 ~ 2047 of the first group within the several sequence output parameters that are in need of query.</p> <p><count> is group number of sequence parameter in need of query. Integer, 1 to 2048.</p>
Example	<p>:SEQUence2:PARAMeter? 1,2</p> <p>Queries 2 groups' sequence parameters from the 1st group for CH2.</p>
Command	:SEQUence[1 2]:REStart
Function	Start output with the first sequence.
Example	<p>:SEQUence2: REStart</p> <p>Sets the CH2 output with the first sequence.</p>
Command	:SEQUence[1 2]:StARt <value>

Function	Sets the sequence number for initial execution. <value>: Integer 0 - 2047
Example	:SEQUence2:STARt 10 Sets the CH2 sequence output to start from the group 11th.
Command	:SEQUence[1 2]:STARt?
Function	Queries the sequence number for initial execution of the channel sequence output.
Example	:SEQUence2:STARt? Returns the initial sequence number of CH2 sequence output.
Command	:SEQUence[1 2][:STATe] {ON OFF}
Function	Enable or disable sequence function. To enable sequence will change state of channel output, make sure the changed output state will Not impact the device connected with power before enabling. Sequence output is activated only when both sequence and channel output are enabled. To modify parameter is Not available when sequence is being enabled. For multi-channel model, change the active channel and set parameter of selected channel. It is Not allowed to enable sequence and delay simultaneously.
Example	:SEQUence2:STATe ON Enable sequence output for CH2.
Command	:SEQUence[1 2] [:STATe]?
Function	Queries the state of sequence output . See previous instruction.

Example	:SEQUence2:STATe? Queries the CH2 state of sequence output. Returns to ON or OFF.
Command	:SEQUence:SYNChronize {ON OFF}
Function	When both CH1 and CH2 are sequence on, turn on or off the sequence synchronization between them.

Example	:SEQUence:SYNChronize ON turn on the sequence synchronization of CH1 and CH2.
Command	:SEQUence[1 2]:TEMPlet:CONSTRUCT
Function	Sends the command. Instrument builds, based on the actively selected templet and set the sequence parameter.

Example	:SEQUence2:TEMPlet:CONSTRUCT Set CH2 to build sequence output according to the selected template and set parameters..
Command	:SEQUence[1 2]:TEMPlet:FALLRate <value>
Function	Sets the falling degree of ExpFall.
Description	<value> Integer from 0 to 10.

Example	:SEQUence2:TEMPlet:FALLR 5 Sets the CH2 falling degree of ExpFall as 5.
Command	:SEQUence[1 2]:TEMPlet:FALLRate?
Function	Queries the falling degree of the active ExpFall.

Example	:SEQUence2:TEMPlet:FALLRate? Queries the CH2 falling degree of the active ExpFall. Returns to an integer ranging from 0 to 10.
---------	---

Command	:SEQUence[1 2]:TEMPlet:INTERval <value>
Function	Sets the time interval.
Description	<value> integer 1s to 300s. Time interval is the duration period in accord with each time parameter of the active selected templet.
Example	:SEQUence2:TEMPlet:INTERval 15 Sets the CH2 time interval as 15s. Pulse templet does Not support this parameter.
Command	:SEQUence[1 2]:TEMPlet:INTERval?
Function	Queries the active time interval.
Example	:SEQUence2:TEMPlet:INTERval? Queries the CH2 active time interval. Returns to an integer between 1 to 300.
Command	:SEQUence[1 2]:TEMPlet:INVErt {ON OFF}
Function	Enable or disable invert function of the active selected templet.
Description	When enabling the invert function, invert the target waveform in instrument first, and build timer parameter. Invert function is available for Sine, Pulse and Ramp templets only.
Example	:SEQUence2:TEMPlet:INVErt ON Enable the invert function of active selected templet for CH2.
Command	:SEQUence[1 2]:TEMPlet:INVErt?
Function	Queries whether the invert function under the active selected templet is enabled.

Example	:SEQUence2:TEMPlet:INVErt? Returns to the templet of CH2 to check if the invert function is ON or OFF.
Command	:SEQUence[1 2]:TEMPlet:MAXValue{<value> MI Nimum MAXimum}
Function	Sets the maximum voltage or current value of the active selected templet.
Description	When voltage is the object to edit, it is the maximum voltage to be set. When current is the object to edit, it is the maximum current to be set. When templet type is Pulse, the command is to set low level value.

Example	:SEQUence2:TEMPlet:MAXValue 5 Sets the CH2 maximum voltage of the active selected templet as 5V.
Command	:SEQUence[1 2]:TEMPlet:MAXValue?
Function	Queries the maximum voltage or current value of the active selected templet.

Example	:SEQUence2:TEMPlet:MAXValue? Queries the CH2 maximum voltage or current value of the active selected templet.
Command	:SEQUence[1 2]:TEMPlet:MINValue{<value> MI Nimum MAXimum}
Function	Sets the minimum voltage or current value of the active selected templet.
Description	When voltage is the object to edit, it is the minimum voltage to be set. When current is the object to edit, it is the minimum current to be set. When templet type is Pulse, the command is to set high level value.

Example	:SEQUence2:TEMPlet:MINValue 0.5 Sets the CH2 minimum voltage of the active selected templet as 0.5V.
Command	:SEQUence[1 2]:TEMPlet:MINValue?
Function	Queries the minimum voltage or current value of the active selected templet.

Example	:SEQUence2:TEMPlet:MINValue? Returns to the CH2 minimum voltage or current value of the active selected templet.
Command	:SEQUence[1 2]:TEMPlet:OBJECT {V C}
Function	Selects the object to be edited by the active templet.
Description	V C : Selects the object to be edited as voltage V or current C.

Example	:SEQUence2:TEMPlet:OBJECT V Sets the CH2 voltage to be edited.
Command	:SEQUence[1 2]:TEMPlet:OBJECT?
Function	Queries the object being edited of the active selected templet.

Example	:SEQUence2:TEMPlet:OBJECT? Returns to the object being edited of the actively selected templet for CH2.
Command	:SEQUence[1 2]:TEMPlet:POINTS <value>
Function	Sets the overall points (adopts the group numbers of sequence parameter constructed by the actively selected templet, which Pulse type does Not support).
Description	<value> The overall points range from 10 to 2048.

Example	:SEQUence2:TEMPlet:POINTs 10 Sets the CH2 overall points as 10.
Command	:SEQUence[1 2]:TEMPlet:POINTs?
Function	Queries the actively set overall points.
Example	:SEQUence2:TEMPlet:POINTs? Returns the CH2 actively set overall points.
Command	:SEQUence[1 2]:TEMPlet:RISERate <value>
Function	Sets the rising degree of ExpRise.
Description	<value> Ranges from 0 to 10.
Example	:SEQUence2:TEMPlet:RISERate 10 Sets the rising degree of ExpRise as 10 for CH2.
Command	:SEQUence[1 2]:TEMPlet:RISERate?
Function	Queries the rising degree of the actively set ExpRise.
Example	:SEQUence2:TEMPlet:RISERate? Returns the rising degree of the actively set ExpRise for CH2.
Command	:SEQUence[1 2]:TEMPlet:SElect {SINE PULSE RAMP UP DN UPDN RISE FALL}
Function	Selects templet type.
Description	SINE PULSE RAMP UP DN UPDN RISE FALL
Example	:SEQUence2:TEMPlet:SElect SINE Sets the selected templet type as SINE for CH2.
Command	:SEQUence[1 2]:TEMPlet:SElect?

Function	Queries the actively selected templet type.
Example	:SEQUence2:TEMPlet:SElect? Returns the actively selected templet type for CH2.
Command	:SEQUence[1 2]:TEMPlet:SYMMetry <value>
Function	Sets the symmetry of RAMP.
Description	<value> Ranges from 0 to 100.
Example	:SEQUence2:TEMPlet:SYMMetry 50 Sets the symmetry of RAMP as 50% for CH2.
Command	:SEQUence[1 2]:TEMPlet:SYMMetry?
Function	Queries the symmetry of the actively set RAMP.
Example	:SEQUence2:TEMPlet:SYMMetry? Returns the symmetry of the actively set RAMP for CH2.
Command	:SEQUence[1 2]:TEMPlet:WIDTh <value>
Function	Sets the pulse width of Pulse.
Description	<value> The available setting range, which is from 1 to (Points-1), is relevant to the actively set period.
Example	:SEQUence2:TEMPlet:WIDTh 5 Sets the pulse width of Pulse as 5s for CH2.
Command	:SEQUence[1 2]:TEMPlet:WIDTh?
Function	Queries the pulse width of the actively set Pulse.
Example	:SEQUence2:TEMPlet:WIDTh? Returns the pulse width of the actively set Pulse for CH2.
Command	:SEQUence[1 2]:TEMPlet:STARt <value>

Function Sets the sequential number of channel sequence output templet to strat execution.

Example :SEQUence2:TEMPlet:STARt 100
 Sets the initial number of CH2 sequence output templet as 100.

Command :SEQUence[1 | 2]:TEMPlet:STARt?

Function Queries the sequential number of channel sequence output to strat execution.

Example :SEQUence2:TEMPlet:STARt?
 Returns to the initial number of CH2 sequence output templet.

Command :SEQUence[1 | 2]:MEMory:SAVE
 {0 | 1 | 2 | 3 | 4 | 5 | 6 | 7 | 8 | 9}

Function Saves the channel sequence output file to the designated location of internal storage. {0 | 1 | 2 | 3 | 4 | 5 | 6 | 7 | 8 | 9} represent the storage locations of 10 files within the internal storage individually.

Example :SEQUence2:MEMory:SAVE 1
 Saves the CH2 sequence output file to the SEQUENCE01 location of internal storage.

Command :SEQUence[1 | 2]:MEMory:LOAD
 {0 | 1 | 2 | 3 | 4 | 5 | 6 | 7 | 8 | 9}

Function Recalls the channel sequence output file saved in the designated location from internal storage. {0 | 1 | 2 | 3 | 4 | 5 | 6 | 7 | 8 | 9} represent the storage locations of 10 files within the internal storage individually.

Example	:SEQUence2:MEMory:LOAD 1 Recalls the CH2 sequence output file of SEQUENCE01 saved in the internal storage.
Command	:SEQUence[1 2]:USB:SAVE <dest>
Function	Saves the channel sequence output file to the designated location of external storage. <dest> indicates the designated location of external storage with file format in either usb:\<name>.CSV or usb:\<name>.SEQ. The file name spans up to the max. 8 alphanumeric characters. .CSV/.SEQ represents the suffix of sequence output file name. Storage location can not be designated when sequence function is enabled.
<hr/>	
Example	:SEQUence2:USB:SAVE USB:\R001.CSV Saves the CH2 sequence output file, by the name of "R001.CSV", to the external storage.
Command	:SEQUence[1 2]:USB:LOAD <dest>
Function	Recalls the channel sequence output file saved in the designated location from external storage. <dest> indicates the designated location of external storage.
<hr/>	
Example	:SEQUence2:USB:LOAD USB:\R001.CSV Recalls the CH2 sequence output file, R001.CSV, saved in the external storage.
Command	:TRIGger:IN[:ENABle] {D0 D1 D2 D3 D4},{ON OFF}
Function	Enables or disables the trigger input function of the specified data line.

Example	:TRIGger:IN D0,ON Enabled trigger input function of the D0 data line.
Command	:TRIGger:IN[:ENABle]?{D0 D1 D2 D3 D4}
Function	Queries the state of the trigger input function of the specified data line.
Example	:TRIGger:IN? D0 Returns the state of the trigger input function of the D0 data line.
Command	:TRIGger:IN:RESPonse{D0 D1 D2 D3 D4},{ON OFF TOGGLE POWER CV CC CR IND SER PAR }
Function	Sets the output response from the trigger input of the specified data line.

Description	ON OFF TOGGLE POWER CV CC CR IND SER PAR }
	Enable output (ON): when the input signal of the specified data line meets the trigger condition, enable the channel output of the actively selected controlled channel.
	Disable output (OFF): when the input signal of the specified data line meets the trigger condition, disable the channel output of the actively selected controlled channel.
	Output Invert mode (TOGGLE): when input signal of the specified cable line meets the set triggering condition, invert the currently selected controlled channel output.
	Output Power mode (POWER): when input signal of the specified cable line meets the set triggering condition, set the currently controlled channel in the power mode.
	Output Load CV mode (CV): when input signal of the specified cable line meets the set triggering condition, set the currently controlled channel in the load CV mode.
	Output Load CC mode (CC): when input signal of the specified cable line meets the set triggering condition, set the currently controlled channel in the load CC mode.
	Output Load CR mode (CR): when input signal of the specified cable line meets the set triggering condition, set the currently controlled channel in the load CR mode.
	Output Individual mode (IND): when input signal of the specified cable line meets the set triggering condition, set CH1/CH2 in the individual power mode.

Output Series mode (SER): when input signal of the specified cable line meets the set triggering condition, set CH1/CH2 in the series power mode.

Output Parallel mode (PAR): when input signal of the specified cable line meets the set triggering condition, set CH1/CH2 in the parallel power mode.

Example	:TRIGger:IN:RESPonse D0,ON Sets the output response from the trigger input of the D0 data line as ON.
 Note	IND SER PAR takes CH1/CH2 as the main body, so it needs to run before executing this parameter: TRIGger:IN:SOURce Dx, CH1, ON and TRIGger:IN:SOURce Dx, CH2, ON.
Command	:TRIGger:IN:RESPonse? {D0 D1 D2 D3 D4}
Function	Queries the output response from the trigger input of the specified data line.
Example	:TRIGger:IN:RESPonse? D0 Returns the output reponse of the trigger input of the queried D0 data line.
Command	:TRIGger:IN:SENSitivity {D0 D1 D2 D3 D4},{LOW MID HIGH}
Function	Sets the trigger sensitivity from the trigger input of the specified data line.
Description	LOW MID HIGH Selecting lower level in trigger sensitivity will avoid false press in noisy environment.
Example	:TRIGger:IN:SENSitivity D0,LOW Sets the trigger sensitivity from the trigger input of D0 data line as LOW.

Command	:TRIGger:IN:SENSitivity? {D0 D1 D2 D3 D4}
Function	Queries the trigger sensitivity from the trigger input of the specified data line.
Example	:TRIGger:IN:SENSitivity? D0 Returns the trigger sensitivity from the trigger input of D0 data line.
Command	:TRIGger:IN:SOURce {D0 D1 D2 D3 D4} , {CH1 CH2 CH3},{ON OFF}
Function	Sets the controlled channel from the trigger input of the specified data line.
Description	{CH1 CH2 CH3} Any of the channels, CH1, CH2, CH3 is available for controlled channel.
Example	:TRIGger:IN:SOURce D0,CH1,ON Sets the controlled channel from the trigger input of D0 data line as CH1.
Command	:TRIGger:IN:SOURce?{D0 D1 D2 D3 D4}
Function	Queries the controlled channel from the trigger input of the specified data line.
Example	:TRIGger:IN:SOURce? D0 Returns the controlled channel from the trigger input of D0 data line.
Command	:TRIGger:IN:TYPE {D0 D1 D2 D3 D4},{RISE FALL HIGH LOW S TATE }
Function	Sets the trigger type from the trigger input of the specified data line.

Description	<p>RISE FALL HIGH LOW STATE</p> <p>It is available to trigger from the following options of signal input: rising edge (RISE), falling edge (FALL), high level (HIGH), low level (LOW) or STATE. For the signal input, high level: 2.5V~3.3V, low level: 0V~0.8V, noise tolerance: 0.4V.</p>
Example	<p>:TRIGger:IN:TYPE D0,RISE</p> <p>Sets the trigger type from the trigger input of D0 data line as RISE.</p>
Command	:TRIGger:IN:TYPE?{D0 D1 D2 D3 D4}
Function	Queries the trigger type from the trigger input of the specified data line.
Example	<p>:TRIGger:IN:TYPE? D0</p> <p>Returns the trigger type from the trigger input of D0 data line.</p>
Command	<p>:TRIGger:OUT:CONDition</p> <p>{D0 D1 D2 D3 D4},{OUTOFF OUTON >V <V =V >C <C =C >P <P =P AUTO},<value></p>
Function	Sets the trigger condition from the trigger output of the specified data line.

Description OUTOFF | OUTON | >V | <V | =V | >C | <C | =C | >P | <P | =P | AUTO

When OUTOFF, OUTON or AUTO is selected, parameter <value> will be omitted.

Input trigger: disable output(OUTOFF) and enable output (OUTON), both of which indicate to disable or enable respectively the trigger when the specified controlled channel output.

Voltage trigger: greater than voltage (>V) , less than voltage (<V) , equal to voltage (=V) , all of which indicate that when the output voltage of the specified controlled channel meets the set trigger condition, it will trigger then.

Current trigger: greater than current (>C) , less than current (<C) , equal to current (=C) , all of which indicate that when the output current of the specified controlled channel meets the set trigger condition, it will trigger then.

Power trigger: greater than power (>P) , less than power (<P) , equal to power (=P) , all of which indicate that when the output power of the specified controlled channel meets the set trigger condition, it will trigger then.

Automatic trigger: triggers automatically only when voltage, current or power triggers meet at least one condition.

When either one of the following modes: voltage trigger (>V、<V、=V) , current trigger (>C、<C、=C) , power trigger >P、<P、=P) is selected, it required to set parameter <value> (the specified voltage, current or power value of the trigger condition).

Example :TRIGger:OUT:CONDition D0,>V,10

Sets the trigger condition from the trigger output of D0 data line as output voltage>10V.

Command :TRIGger:OUT:CONDition? {D0 | D1 | D2 | D3 | D4}
 Function Queries the trigger condition from the trigger output of the specified data line.

Example :TRIGger:OUT:CONDition? D0
 Returns the trigger condition from the trigger output of D0 data line.

Command :TRIGger:OUT[:ENABLE]
 {D0 | D1 | D2 | D3 | D4},{ON | OFF}

Function Enables or disables the trigger output function of the specified data line.

Description After enabling trigger output function, the specified data line will, when the output signal of the specified controlled channel meets the set trigger condition, output the specified level or square wave based on the setting of output signal.

Example :TRIGger:OUT D0,ON
 Enables the trigger output function of D0 data line.

Command :TRIGger:OUT[:ENABLE]?{D0 | D1 | D2 | D3 | D4}

Function Queries the state of the trigger output function of the specified data line.

Example :TRIGger:OUT? D0
 Returns the state of the trigger output function of D0 data line.

Command :TRIGger:OUT:POLARity
 {D0 | D1 | D2 | D3 | D4},{POSitive | NEGAtive}

Function Sets the polarity of the output signal from the trigger output of the specified data line.

Description	<p>POSitive NEGAtive</p> <p>Positive polarity (POSitive): when trigger condition is met, it will output the actively specified output signal.</p> <p>Negative polarity (NEGAtive) when trigger condition is met, it will invert and then output the actively specified output signal.</p>
Example	<p>:TRIGger:OUT:POLARity D0,POSitive</p> <p>Sets the polarity of the output signal from the trigger input of D0 data line as POSitive.</p>
Command	:TRIGger:OUT:POLARity? {D0 D1 D2 D3 D4}
Function	Queries the polarity of the output signal from the trigger input of the specified data line.
Example	<p>:TRIGger:OUT:POLARity? D0</p> <p>Returns the polarity of the output signal from the trigger input of D0 data line.</p>
Command	:TRIGger:OUT:SOURce {D0 D1 D2 D3 D4},{CH1 CH2 CH3}
Function	Sets the controlled channel from the trigger output of the specified data line.
Description	<p>CH1 CH2 CH3</p> <p>Any of the channels, CH1, CH2, CH3 is available for selection as controlled channel of trigger output.</p>
Example	<p>:TRIGger:OUT:SOURce D0,CH1</p> <p>Sets the controlled channel from the trigger output of D0 data line as CH1.</p>
Command	:TRIGger:OUT:SOURce?{D0 D1 D2 D3 D4}
Function	Queries the controlled channel (channel) from the trigger output of the specified data line.

Example :TRIGger:OUT:SOURce? D0
Returns the controlled channel from the trigger output of D0 data line.

Command :TRIGger:OUT:STATe [D0 | D1 | D2 | D3 | D4,]
{ON | OFF}

Function Set the data line trigger output state on or off.

Example :TRIGger:OUT:STATe D0,ON
Set the data line D0 trigger output state on.

Command :TRIGger:OUT:STATe? [D0 | D1 | D2 | D3 | D4]

Function Query trigger output status of data line.

Example :TRIGger:OUT:STATe? D0
Query trigger output status of data line D0.

Status Commands

Command STATus?

Function Returns the Status .

Return parameter 8 bytes in the following format

Byte	Item	Description
0	CH1	0=CC mode, 1=CV mode
1	CH2	0=CC mode, 1=CV mode
2, 3	Tracking	01=Independent, 11=Tracking series, 10=Tracking parallel
4	Beep	0=Off, 1=On
5	Output	0=Off, 1=On
6, 7	Baud	00=115200bps, 01=57600bps, 10=9600bps

Note Byte 6,7: 11=19200bps, 38400bps, LAN, GPIB

Example STATus?

Command	:STATus:PRESet
Function	Clears the operation event enable registers, the measurement event enable registers and the questionable event register, The unit will then return to the default settings status.

Example	:STATus:PRESet
---------	----------------

Command	:STATus:OPERation[:EVENT]?
Function	Read the operation event register.

Example	:STATus:OPERation? Reads the operation event register.
---------	---

Command	:STATus:OPERation:CONDition?
Function	Read the operation condition status register.

Example	:STATus:OPERation:CONDition? Read the contents of the operation condition status register.
---------	---

Command	:STATus:OPERation:ENABLE <NRf>
Function	Programs the operation enable status register.
Description	<NRf> 8: CL (Current enable bit). 16: CLT (Current limit tripped enable bit). 64: PSS (Power supply shutdown enable bit).

Example	:STATus:OPERation:ENABLE 64 Enable the power supply shutdown bit.
---------	--

Command	:STATus:OPERation:ENABLE?
Function	Read the operation enable status register.

Example	:STATus:OPERation:ENABLE? Read the contents of the operation enable status register.
Command	:STATus:MEASurement[:EVENT]?
Function	Reads the measurement event status register.
Example	:STATus:MEASurement? Reads the contents of the measurement event status register.
Command	:STATus:MEASurement:ENABLE <NRf>
Function	Program the measurement enable status register.
Description	<NRf> 8: ROF (reading overflow enable bit). 16: PTT (pulse trigger timeout enable bit). 32: RAV (Reading available enable bit). 512: Buffer full enable bit. The register is 16 bits. If <value> is between 512 and 1,023, it is certainly valid. If <value> is between 1,024 and 65,535, ensure Cal (bit8) is a valid value for it to work.
Example	:STATus:MEASurement:ENABLE 8 Enables the ROF bit.

Command	:STATus:MEASurement:ENABLE?
Function	Read the measurement enable status register.
Example	:STATus:MEASurement:ENABLE? Read the contents of the measurement enable status register.
Command	:STATus:MEASurement:CONDition?
Function	Read the measurement condition status register.
Example	:STATus:MEASurement:CONDition? Read the contents of the measurement condition status register.
Command	:STATus:QUEStionable[:EVENT]?
Function	Read the questionable event status register.
Example	:STATus:QUEStionable? Read the questionable event status register.
Command	:STATus:QUEStionable:CONDition?
Function	Read the questionable condition status register.
Example	:STATus:QUEStionable:CONDition? Read the questionable condition status register.
Command	:STATus:QUEStionable:ENABle <NRf>
Function	Programs the questionable enable status register.
Description	<NRf> 256: CAL (Calibration summary enable bit). Register is 16 bits. If <value> is between 256 and 511, it is certainly valid. If <value> is between 512 and 65,535, ensure Cal (bit8) is a valid value.

Example	:STATus:QUESTionable:ENABle 256 Sets the CAL bit.
Command	:STATus:QUESTionable:ENABle?
Function	Read the questionable enable status register.

Example	:STATus:QUESTionable:ENABle? Read the contents of the questionable enable status register.
Command	:STATus:QUEue[:NEXT]?
Function	Read the next message in the error queue.

Example	:STATus:QUEue? Read the next error message.
Command	:STATus:QUEue:ENABle <list>
Function	Specifies which error and status messages get enabled for the error queue.
Description	<list> (-440:+900): Full range error messages. (-110): Single error message. (-110:-222): A specific range of error messages. (-110:-222, -220): A specific range of error messages and a single error message (separated by a comma).

Example	:STATus:QUEue:ENABle (-110:-222) Enables error messages that are between error message -100 and -222.
---------	--

Command	:STATus:QUEue:ENABLE?
Function	Read the error and status messages that have been enabled.
Example	:STATus:QUEue:ENABLE? Returns the contents of the enabled error and status messages.
Command	:STATus:QUEue:DISable <list>
Function	Specifies which messages will not be placed in the error queue.
Description	<list> (-440:+900): Full range error messages. (-110): Single error message. (-110:-222): A specific range of error messages. (-110:-222, -220): A specific range of error messages and a single error message (separated by a comma).
Example	:STATus:QUEue:DISable (-110:-222) The error messages in the range of -110 to -222 will not appear in the error queue.
Command	:STATus:QUEue:DISable?
Function	Reads the disabled messages.
Example	:STATus:QUEue:DISable? Returns the disabled messages.
Command	:STATus:QUEue:CLEar
Function	Empty all the messages from the error queue.

Example

:STATus:QUEue:CLEar

Empty all the messages from the error queue.

System Commands

Command :SYSTem:VERSion?

Function Query the SCPI version.

Example :SYSTem:VERSion?

Query the SCPI version.

Command :SYSTem:ERRor?

Function Read and clear the last error and from the error queue.

Example :SYSTem:ERRor?

Read and clear the last error and from the error queue.

Command ERR?

Function Checks the error status and returns the last error message.

Message contents ^o	Descriptions ^o
a ^o Program mnemonic too long ^o	The command length must be 15 characters or less. ^o
b ^o Invalid character ^o	Invalid characters, such as symbols, are entered. Example: VOUT# ^o
c ^o Missing parameter ^o	The parameter is missing from the command. Example: VSET: (should have a number) ^o
d ^o Data out of range ^o	The entered value exceeds the specification. Example: VSET:33 (should be $\leq 32V$) ^o
e ^o Command not allowed ^o	The entered command is not allowed in the circumstance. Example: trying to set CH2 output while in the tracking mode. ^o
f ^o Undefined header ^o	The entered command does not exist, or the syntax is wrong. ^o

Command	:SYSTem:CLear
Function	Clear the error messages.
Example	:SYSTem:CLear Clears the error queue.
Command	:SYSTem:POSetup <name>
Function	Set the power on configuration.
Description	<name> RST: Machine default settings. Last: Machine last settings.
Example	:SYSTem:POSetup RST Set the power on configuration to RST.
Command	:SYSTem:POSetup?
Function	Query the power on configuration.
Example	:SYSTem:POSetup? Query the power on configuration.
Command	:SYSTem:COMMunicate:LAN:DHCP[:STATe]
Function	Sets the DHCP state on or off.
Description	 0/OFF: DHCP off 1/ON:DHCP on Note: The :SYSTem:COMMunicate:LAN:APPLY command must be executed before the DHCP settings can take effect.
Example	:SYSTem:COMMunicate:LAN:DHCP ON Enable DHCP.
Command	:SYSTem:COMMunicate:LAN:DHCP[:STATe]?

Function	Query the DHCP status.
Example	:SYSTem:COMMunicate:LAN:DHCP? Query the DHCP state.
Command	:SYSTem:COMMunicate:LAN:IPADdress <IPaddress>
Function	Sets the IP address.
Description	<IP address> ASCII string, within the range of 1.0.0.0 to 223.255.255.255 (excluding 127.nnn.nnn.nnn). Note: This command is only applicable if for the manual IP mode. The SYSTem:COMMunicate:LAN:APPLY command needs to executed before the IP address settings can take effect.
Example	:SYSTem:COMMunicate:LAN:IPADdress 172.131.161.152 Sets the IP address to 172.131.161.152.
Command	:SYSTem:COMMunicate:LAN:IPADdress?
Function	Queries the IP address.
Example	:SYSTem:COMMunicate:LAN:IPADdress? Queries the IP address.
Command	:SYSTem:COMMunicate:LAN:SMASK <mask>
Function	Sets the subnet mask.
Description	<mask> ASCII string, within the range of 1.0.0.0 to 255.255.255.255. The SYSTem:COMMunicate:LAN:APPLY command needs to be executed before the subnet mask setting can take effect.

Example	:SYSTem:COMM:LAN:SMAS 255.255.255.0 Sets the subnet mask to 255.255.255.0.
Command	:SYSTem:COMMunicate:LAN:SMASK?
Function	Query the subnet mask.
Example	:SYSTem:COMMunicate:LAN:SMASK? Query the subnet mask.
Command	:SYSTem:COMMunicate:LAN:GATEway <IPaddress>
Function	Sets the gateway IP address.
Description	<IP address> ASCII string, within the range of 1.0.0.0 to 223.255.255.255 (excluding 127.nnn.nnn.nnn). The SYSTem:COMMunicate:LAN:APPLY command needs to be executed before the gateway IP address setting can take effect.
Example	:SYSTem:COMMunicate:LAN:GATEway 172.16.3.1 Sets the gateway IP to 172.16.3.1.
Command	:SYSTem:COMMunicate:LAN:GATEway?
Function	Queries the gateway IP.
Example	:SYSTem:COMMunicate:LAN:GATEway? Queries the gateway IP.
Command	:SYSTem:COMMunicate:LAN:MANualip[:STATe]
Function	Allow the IP address to be set manually. 0/OFF: disable the manual IP address. 1/ON: enable the manual IP address.

Example	:SYSTem:COMMunicate:LAN:MANualip ON Enables a manual IP address to be set.
Command	:SYSTem:COMMunicate:LAN:MANualip[:STATe]?
Function	Queries whether manual IP addressing has been enabled or disabled.
Example	:SYSTem:COMMunicate:LAN:MANualip? Queries the status of the manual IP addressing.
Command	:SYSTem:COMMunicate:LAN:APPLY
Function	When this command is executed, all the LAN settings are applied.
Example	:SYSTem:COMMunicate:LAN:APPLY Applies all the LAN settings.
Command	:SYSTem:REMote
Function	Sets the unit to remote control.
Example	:SYSTem:REMote Sets to remote control mode.
Command	REMOTE
Function	Sets the unit to remote control.
Example	REMOTE
Command	:SYSTem:BEEPer:STATe
Function	Turn the buzzer on or off. 0/OFF: Turn the buzzer off. 1/ON: Turn the buzzer on.

Example	:SYSTem:BEEPer:STATe OFF Turns the buzzer off.
Command	BEEP<Boolean>
Function	Turn the buzzer on or off. <Boolean> 0:off, 1:on
Example	BEEP1 Turns on the beeper
Command	:SYSTem:BEEPer:STATe?
Function	Queries the buzzer status.
Example	:SYSTem:BEEPer:STATe? Queries the buzzer status.
Command	:SYSTem:LOCAl
Function	Disable remote control mode.
Example	:SYSTem:LOCAl Disables remote control mode.
Command	LOCAL
Function	Exits remote mode and sets the instrument to local mode.
Example	LOCAL
Command	:SYSTem:INTerface [USB RS232 GPIB LAN]
Function	Sets the interface type.

Example	:SYSTem:INTerface USB Sets the interface type to USB.
Command	:SYSTem:LANGUage [CHINese ENGLISH]
Function	Sets the syetem language.
Example	:SYSTem:LANGUage ENGLISH Sets the syetem lanuage to English.
Command	:SYSTem:LANGUage?
Function	Query the syetem lanuage.
Example	:SYSTem:LANGUage? .
Command	:SYSTem:BAUDrate:USB [9600 19200 38400 57600 115200]
Function	Sets the USB baud rate.
Example	:SYSTem:BAUDrate:USB 9600 Sets the USB baud rate to 9600.
Command	:SYSTem:BAUDrate:USB?
Function	Query the USB baud rate.
Example	:SYSTem:BAUDrate:USB?
Command	:SYSTem:BAUDrate:RS232 [9600 19200 38400 57600 115200]
Function	Sets the RS232 baud rate.
Example	:SYSTem:BAUDrate:RS232 9600 Sets the RS232 baud rate to 9600.
Command	:SYSTem:BAUDrate:RS232?

Function	Query the RS232 baud rate.
Example	:SYSTem:BAUDrate:RS232?
Command	BAUD<NR1>
Function	Sets the baud rate to 9600 / 57600 / 115200. <NR1> 0: 115200bps, 1: 57600bps, 2: 9600bps
Example	BAUD0 Sets the baud rate to 115200bps
 Note	It functions only when RS232 or USB is connected.
Command	HELP?
Function	Shows the Simple command list.

Return parameters	ISET<x>:<NR2> Sets the value of current.
	VSET<x>:<NR2> Sets the value of voltage.
	ISET<x>? Return the value of current.
	VSET<x>? Return the value of voltage.
	IOUT<x>? Returns actual output current .
	VOUT<x>? Returns actual output voltage.
	TRACK<NR1> Sets the output of the power supply working on independent or tracking mode.
	BAUD< NR1 >Set the value of baud rate.
	RCL<NR1> Recall the setting data from the memory which previous saved.
	SAV<NR1> Saves the setting data to memory.
	BEEP<Boolean> Sets the BEEP state on or off.
	OUT<Boolean> Sets the output state on or off.
	LOCAL Return to local mode.
	REMOTE Return to remote mode.
	*IDN? Returns instrument identification.
	ERR? Returns instrument error messages.
	STATUS? Returns the power supply state.

System Related Commands

Command *IDN?

Function Read the instrument identification <string>.

Description <string> The return string contains four fields, each separated by a comma. The first field is the manufacturer, followed by the model name, serial number and the version number.

Example *IDN?

 Returns the GPP identification:

 GW INSTEK,GPP-3060,XXXXXXXXXX,V1.00

 GW INSTEK: Manufacturer,

 GPP-3060: Model name,

 XXXXXXXXXXX: Serial number,

 V1.00: version number.

Command *RST

Function Resets the unit to RST default conditions.

Example *RST

 Resets the unit.

Command *SAV <NRf>

Function Save the current setup to the selected save location.

Description <NRf>: 0 - 9, Corresponding to STATE00-STATE09.

Example *SAV 1

 Stores the setting in memory 1(STATE01).

Command SAV<NR1>

Function	Save the current setup to the selected save location.
Description	<NR1> : 0-9, Corresponding to STATE00-STATE09.
	SAV1
	Stores the setting in memory 1(STATE01).
Command	*RCL <NRf>
Function	Recall the selected save setting from memory.
Description	<NRf>: 0 - 9 , Corresponding to STATE00-STATE09.
Example	*RCL 2
	Recalls the setting stored in memory 2(STATE02).
Command	RCL<NR1>
Function	Recall the selected save setting from memory.
Description	<NR1>: 0 - 9 , Corresponding to STATE00-STATE09.
Example	RCL2
	Recalls the setting stored in memory 2(STATE02).

SCPI Status Registers SCPI

The SCPI instrument configuration is controlled by the status registers. The Status system records various instrument conditions into three main register groups: The status byte register, the standard event register group and the questionable data register group. The status byte register records a high-level summary of the other register groups. The following diagram is the SCPI Status System diagram.

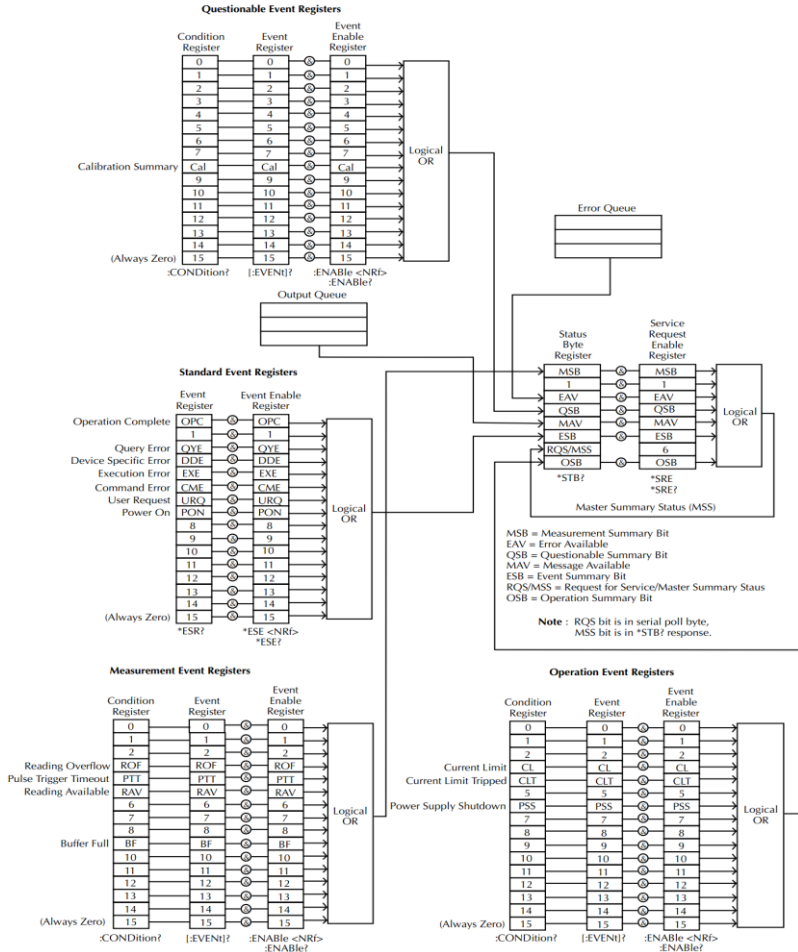

*Note: URQ indicates that the "Lock" key on the panel has been used. (Entering lock from unlock or Entering unlock from lock).

Event Registers

The operation, measurement and questionable status register groups all have event registers. The event registers are read only registers that reflect the status of the unit. Individual bits in the event registers are latched (set) when a corresponding event occurs and will remain latched even if the corresponding event changes, as long as the event bit is still set. The register query (*ESR) or the command (*CLS) will automatically clear any set bits in the event registers. The reset command (*RST) will not clear the bits in the event register. Queries for the event registers will return a binary-weighted decimal value that represents the state of all the bits in an event register.

Enable Registers

The enable registers define which bits in the corresponding event register can be latched (set). The enable register can be read and written to. Any queries for the enable register will not clear the value in the register. The *CLS command will not clear the enable register, but will clear the events in the event register. To allow the individual bits in the event registers to be set, the corresponding bits in the enable registers must be set, where each bit is represented by a binary number.

Status Byte Register

The status byte register reports the status of the other status registers. The message available bit (bit 4), will indicate when there is a message in the output buffer. Clearing an event register will clear the corresponding bit in the status byte condition register. Reading all the data in the output buffer will clear the message available bit. To set the enable register mask for the status byte register and to generate an SRQ (service request) you must use the *SRE command to write the appropriate decimal value to the register.

Bit Definition for the Status Byte Register

Bit number	Decimal value	Definition
0 Not used	1	Not used, returns "0"
1 Not used	2	Not used, returns "0"
2 Error Queue	4	Indicates that one or more errors are stored in the error queue.
3 Questionable Summary bit	8	One or more bits are set in the questionable data register (for enabled events).
4 Message Available bit	16	Indicates that a message is available in the output queue.
5 Standard Event Summary bit.	32	Indicates that one or more bits are set in the standard event register. (For enabled events).
6 Master Summary bit	64	Indicates that a summary bit is set in the status byte register. (for enabled summary bits)
7 Unused	128	Not used, returns "0"

The status byte condition register is cleared when one of the following occurs:

- *CLS command is used to clear the status byte register.
- You read the event register from another register group (only clear the corresponding bit in the condition register)

The status byte enable register is cleared when the following occurs:

- When the *SRE 0 is command is executed.

Use the *STB? query to read the status byte register.

The *STB? query will return the contents of the status byte register as long as the bit 6 (MSS) has been cleared.

Using the *OPC? query to place a signal in the output buffer.

In general it is best to use the Operation Complete Bit (bit 0) in the standard event register to check to see if an operation/command has completed. After executing the *OPC command, the OPC bit will be set to 1. If a command or query is placed in the output buffer immediately before the *OPC command is sent, the Operation Complete Bit can be used to determine when the information can be used. However if too many commands/queries are executed prior to the execution of the *OPC command, the output buffer could become saturated and the unit will stop taking readings.

Standard Event Register

The Standard Event Register reports the following types or events: Power on has been detected, command syntax errors, command execution errors, self test and execution errors, query errors or if the *OPC command is executed. Any one or more of these events will set the standard event summary bit in the status byte register. To set a mask for the enable register, a binary-weighted decimal number must be written using the *ESE command.

Bit Definition for the Standard Event Register

Bit number	Decimal value	Definition
0 Operation Complete Bit	1	The *OPC command will set this bit when all overlapping operations have completed (including the *OPC command itself).
1 Not used	2	Not used, returns 0.
2 Query Error	4	The instrument tried to read the error queue when the queue was empty or the queue was read before a new command was given or the input/output buffers are full.
3 Device Error	8	A self-test, calibration or other device-specific error.

4 Execution Error	16	An execution error.
5 Command Error	32	A command syntax error.
6 Not used	64	Not used, return 0.
7 Power On	128	This bit is set if the power supply has been reset from the last time you read the event register.

The following will clear the standard event register:

- The *CLS command is executed.
- The *ESR? command is used to query the event register.

The following will clear the standard event enable register.

- The *ESE command is executed.

Status Byte Register Commands

Command	*SRE <Allowed values>
Function	Service request enable register (SRER) command that writes a binary weighed value which determines which events in the status byte register are enabled.
Function	Allowed Decimal vales: 0~255 values
Example	*SRE 7 Returns the SRER setting (0000 0111)
Command	*SRE?
Function	Queries the status byte enable register. This command returns a binary-weighted decimal number that indicates which bits are set in the status byte register. The range is from 0~255.

Example	*SRE? Returns "7", which are the contents of the service request enable register.
---------	--

Command	*STB?
---------	-------

Function	Query the status byte register. This is the same as performing a serial poll, however the master summary bit (MSS, bit 6) will not be cleared by the *STB command. The return value range is from 0 to 255.
----------	---

Example	*STB?
---------	-------

Returns 81 if the status byte register is set to 0101 0001.

Standard Event Register Commands

Command	*ESE<Allowed Values>
---------	----------------------

Function	Sets the standard event enable register. The allowable value range is 0~255.
----------	--

Example	*ESE 65
---------	---------

Sets the ESER as 0100 0001.

Command	*ESE?
---------	-------

Function	Queries the standard event enable register. It returns a binary-weighted decimal value representing all the enabled bits in the standard event register.
----------	--

Example	*ESE?
---------	-------

Returns 65, as the ESER is set as 0100 0001.

Command	*ESR?
---------	-------

Function Queries the standard event register. It returns a binary-weighted decimal value in the range of 0~255.

Example *ESR?
It returns 65, as the ESER is set as 0100 0001.

Other Status Register Commands

Command	*CLS
Function	Clears the status byte summary registers and the all event registers.
Example	*CLS Clears all the event registers, which include Standard event registers, Operation event registers, Measurement event registers, Questionable event registers.
Command	*OPC
Function	After all the pending operations are complete, sets the operation complete bit in the standard event status register.
Example	*OPC
Command	*OPC?
Function	Will return "1" to the output queue when all pending operations have been completed.
Example	*OPC? After the last command is executed, will return a "1" to the output queue.

Errors

Error Message

- Errors are stored in a first in-first out (FIFO) order. The first error message that is returned is the first error message that was stored. When an error is read it is also cleared from the queue.
- If there are more than 10 errors produced the last error in the queue is replaced with “Que overflow”. Unless the error queue is cleared, no more errors can be written to the error queue. If there are no errors in the error queue, the instrument will return “No error”.
- To clear the error queue, you can use the :SYSTem:CLEar command or cycle the power. When you read a message from the error queue that message will be cleared from the error queue. Using the *RST command to reset the instrument does not clear the error queue.
- Remote control instructions can be used to clear the error queue. See the instructions listed in the previous chapter for details.

Command Errors

- 440 Query unterminated after indefinite
- 430 Response
- 420 Query deadlocked
- 410 Query unterminated
- 363 Query interrupted
- 350 Input buffer overrun
- 330 Queue overflow
- 314 Self-test failed
- 315 Save/recall memory lost
- 260 Configuration memory lost
- 241 Expression error
- 230 Hardware missing

- 225 Data corrupt or stale
- 224 Out of memory
- 223 Illegal parameter value
- 222 Too much data
- 221 Parameter data out of range
- 220 Settings conflict
- 200 Parameter error
- 178 Execution error
- 171 Expression data not allowed
- 170 Invalid expression
- 161 Expression error
- 160 Invalid block data
- 158 Block data error
- 154 String data not allowed
- 151 String too long
- 150 Invalid string data String data error
- 148 Character data not allowed
- 144 Character data too long
- 141 Invalid character data
- 140 Character data error
- 124 Too many digits
- 123 Exponent too large
- 121 Invalid character in number
- 120 Numeric data error
- 114 Header suffix out of range
- 113 Undefined header
- 112 Program mnemonic too long
- 111 Header separator error

-110	Command header error
-109	Missing parameter
-108	Parameter not allowed
-105	GET not allowed
-104	Data type error
-103	Invalid separator
-102	Syntax error
-101	Invalid character
-100	Command error
+000	No error
+101	Operation complete
+301	Reading overflow
+302	Pulse trigger detection timeout
+306	Reading available
+310	Buffer full
+320	Current limit event
+321	Current limit tripped event
+409	OTP Error
+410	OVP Error
+438	Date of calibration not set
+440	Gain-aperture correction error
+500	Calibration data invalid
+510	Reading buffer data lost
+511	GPIB address lost
+512	Power-on state lost
+514	DC Calibration data lost
+515	Calibration dates lost
+522	GPIB communication data lost

- +610 Questionable calibration
- +900 Internal system error

A PPENDIX

Replacing the Fuse

Steps

Remove the power cord and then take out the box using a small screw driver.

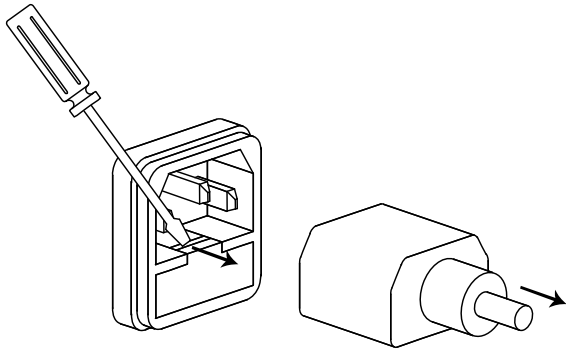

The fuse is stored in the housing.

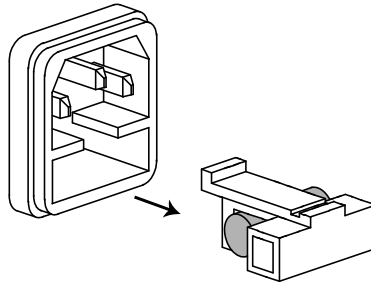



Rating

- T5A/250V (220V/230V)
- T12A/250V (100V/120V)

Specifications

The specifications apply under the following conditions: The GPP is powered on for at least 30 minutes, within +20°C-+30°C.

Power Mode		
Output Rating	CH1/CH2	0 - 30.000V , 0 - 6.0000A (GPP-3060)
	Independent	0 - 60.000V , 0 - 3.0000A (GPP-6030)
	CH1, CH2	0 - 60.000V , 0 - 6.0000A (GPP-3060)
	Series	0 - 120.000V , 0 - 3.0000A (GPP-6030)
	CH1, CH2	0 - 30.000V , 0 - 12.0000A (GPP-3060)
	Parallel	0 - 60.000V , 0 - 6.0000A (GPP-6030)
Voltage	Line regulation	$\leq 0.01\% + 3\text{mV}$
	Load regulation	$\leq 0.01\% + 5\text{mV}$ (rating current $\leq 10\text{A}$)
	Ripple & noise (5Hz-1MHz)	$\leq 1\text{mVrms}$,
	Transient recovery time	$\leq 100\mu\text{s}$ (50% load change, minimum load 0.5A)
	Temperature coefficient	$\leq 300\text{ppm}/^\circ\text{C}$
	Current	Line Regulation
Load Regulation		$\leq 0.01\% + 3\text{mA}$
Ripple & noise		$\leq 2\text{mArms}$
Tracking Operation		$\leq 0.1\% + 10\text{mV}$ of Master (GPP-3060) $\leq 0.2\% + 20\text{mV}$ of Master (GPP-6030) (No Load, with load add load regulation $\leq 200\text{mV}$)
Parallel regulation	Line:	$\leq 0.01\% + 3\text{mV}$
	Load:	$\leq 0.01\% + 5\text{mV}$ (rating current $\leq 10\text{A}$) $\leq 0.02\% + 5\text{mV}$ (rating current $> 10\text{A}$)
	Series regulation	Line: $\leq 0.01\% + 5\text{mV}$ Load: $\leq 200\text{mV}$
	Ripple & noise	$\leq 2\text{mVrms}$ (5Hz-1MHz)

 Note	Tracking is not supported in LOAD mode.	
Resolution	Voltage	programming 1mV ,readback 0.1mV (GPP-3060) programming 2mV ,readback 0.1mV (GPP-6030)
	Current	programming 0.2mA,readback 0.1mA (GPP-3060) programming 0.1mA,readback 0.1mA (GPP-6030)
Accuracy	Ammeter	full scale:6.2A(GPP-3060),3.2A (GPP-6030) programming 5 digits , readback 5 digits
	Voltmeter	full scale:32V(GPP-3060), 62V(GPP-6030) programming 5 digits,readback 6 digits
	Setting accuracy	Voltage: ± (0.03% of reading + 10mV) Current: ± (0.3% of reading + 10mA)
	Readback accuracy	Voltage: ± (0.03% of reading + 10mV) Current: ± (0.3% of reading + 10mA)
Bindpost	Output voltage	1.8V/2.5V/3.3V/5.0V, ±5%
	Output current	5A
CH3	Line regulation	≤ 3mV
	Load regulation	≤ 5mV
	Ripple & noise	≤ 2mVrms (5Hz - 1MHz)
	Transient recovery time	≤ 100μs (50% load change, minimum load 0.5A)
USB Port	Output	1.8V/2.5V/3.3V/5.0V, ±0.35V, 3A
 Warning	The output current from the 2 terminals should Not exceed 5A.	

Load Mode		
Display	Voltage	1-32.00V (GPP-3060) 1-62.00V (GPP-6030)
	Current	0-6.200A (GPP-3060) 0-3.200A (GPP-6030)
	Power	0-50.00W(CH1/CH2)
CV Mode	CH1/CH2	1.500V - 32.00V (GPP-3060) 1.500V - 62.00V (GPP-6030)

	Setting/Re adback accuracy Resolution	$\leq \pm(0.1\% + 30\text{mV})$ 10mV
CC Mode	CH1/CH2 Setting/Re adback accuracy Resolution	0 - 6.200A (GPP-3060) 0 - 3.200A (GPP-6030) $\leq \pm(0.3\% + 10\text{mA})$ 1mA
CR Mode	CH1/CH2 Setting/Re adback accuracy Resolution	1 Ω - 1k Ω $\leq \pm(3\% + 1 \Omega)$ (voltage $\geq 0.1\text{V}$, and current $\geq 0.1\text{A}$) 1 Ω
Other Mode		
OVP	Power mode Load mode Setting accuracy Resolution	CH1/CH2:OFF,ON(0.5V-35.0V) (GPP-3060) OFF,ON(0.5V-65.0V) (GPP-6030) CH3:Fixed 5.5V OFF,ON(1.5V-35.0V) (GPP-3060) OFF,ON(1.5V-65.0V) (GPP-6030) $\pm 100\text{mV}$ 100mV
OCP	Power/Load mode Setting accuracy Resolution	CH1/CH2:OFF,ON(0.05A-6.50A) (GPP-3060) OFF,ON(0.05A-3.50A) (GPP-6030) CH3:3.1A(USB port) $\pm 20\text{mA}$ 10mA
Insulation resistance	Between chassis and terminal Between chassis and DC power cord	20M Ω or above (DC 500V) 30M Ω or above (DC 500V)
Operation Environment	Indoor use, Altitude: Ambient temperature: Relative humidity: Installation category: Pollution degree:	$\leq 2000\text{m}$ 0 ~ 40°C $\leq 80\%$ II 2

Storage Environment	TEMPERATURE: -10°C ~ 70°C HUMIDITY: ≤70%
Power input consumption	AC 100V/120V/220V/230V±10%, 50/60Hz 900VA,680W
Accessories	CD User manual x1, Quick Start manual x1, Power Code x1 Test lead: GTL-104A x 3 (Europe) Test lead: GTL-204A x 3, GTL-201A x1
Dimensions	213 (W) x 145 (H) x 362 (D) mm
Weight	Approx. 10kg

Optional Accessories

USB Cable	GTL-246	USB 2.0, A-B type
-----------	---------	-------------------

Declaration of Conformity

We

COMBINED TEST SOLUTIONS

declare, that the below mentioned product

Type of Product: **Programmable DC Power Supply**

Model Number: **GPP-3060/GPP-6030**

satisfies all the technical relations application to the product within the scope of council:

Directive:2014/30/EU; 2014/35/EU;

The above product is in conformity with the following standards or other normative documents:

© EMC

EN 61326-1: 2013 EN 61326-2-1: 2013	Electrical equipment for measurement, control and laboratory use -- EMC requirements (2013)
Conducted & Radiated Emission EN 55011: 2016+A1:2017 (Class A)	Electrical Fast Transients EN 61000-4-4: 2012
Current Harmonics EN 61000-3-2: 2019	Surge Immunity EN 61000-4-5: 2014/AMD1:2017
Voltage Fluctuations EN 61000-3-3: 2013+A1:2019	Conducted Susceptibility EN 61000-4-6: 2014
Electrostatic Discharge EN 61000-4-2: 2009	Power Frequency Magnetic Field EN 61000-4-8: 2010
Radiated Immunity EN 61000-4-3:2006+A1:2007+A2:2010	Voltage Dip/ Interruption EN 61000-4-11: 2020

© Safety

Low Voltage Equipment Directive 2014/35/EU	
Safety Requirements	EN 61010-1: 2010(Third Edition) +A1:2019

Combined Test Solutions,
4 Commerce Way, Stanbridge Road,
Leighton Buzzard, LU7 4RW

T: 01525 374466
E: sales@ctstest.co.uk
W: www.ctstest.co.uk

