



Programmable DC Power Supply

PLR Series

USER MANUAL



ISO-9001 CERTIFIED MANUFACTURER

This manual contains proprietary information, which is protected by copyright. All rights are reserved. No part of this manual may be photocopied, reproduced or translated to another language without prior written consent of Combined Test Solutions.

The information in this manual was correct at the time of printing. However, Combined Test Solutions continues to improve products and reserves the rights to change specification, equipment, and maintenance procedures at any time without notice.

Table of Contents

SAFETY INSTRUCTIONS	4
PLR SERIES.....	9
About this Manual.....	9
Outline of Product.....	10
Features	10
Prior to Use.....	14
Connect the Power Cable.....	16
Connect to the Output Terminals	16
PANELS	25
Front Panel.....	25
Operation Panel	27
Rear Panel.....	34
GENERAL INSTRUCTIONS.....	39
Connecting loads.....	39
FUNCTIONS AND OPERATION PROCEDURES	43
Operation modes	43
Turning on Power	43
Basic Operation	47
Output Functions	50
Memory Function	51
Switching the display in the Voltage/Current Indicator Display	53
Protective Functions.....	58
Key Lock/Local Function.....	62
MENU KEY SETTINGS.....	65

Output Off Timers	68
Specifying the automatic cancellation time of the setting menu display	72
Specifying Settings when the Power is Turned On ..	74
Clearing the Memory	91
MASTER-SLAVE OPERATION	101
Configuration of Master and Slave Units	101
Parallel Master-Slave Operation	108
Serial Master-Slave Operation	110
SEQUENCE OPERATION	112
Sequence Operation	112
Sequence Programs	116
Confirming the Step No. and the Step Being Executed	117
Confirming the Setting Items for Steps	120
Confirming the settings for sequence program execution	122
Executing Sequence Programs	124
OPERATION BY EXTERNAL ANALOG SIGNAL	132
Analog Interface Boards	132
Operating the PLR-ARC board	139
INTERFACE OPTION	157
Accessories	157
REMOTE CONTROL	158
Outline	158
Communication Control	177
Commands	183
Cautions about Communication	213
Communication Specifications	214

SPECIFICATIONS218

- Individual Specifications 218
- Common Specifications of PLR Series 222
- PLR Series Compatible Specifications..... 223

APPENDIX224

- Trouble Shooting 224
- Outside Dimensions 228
- Declaration of Conformity 229
- Contact information 230

S SAFETY INSTRUCTIONS

This chapter contains important safety instructions that you must follow during operation and storage. Read the following before any operation to insure your safety and to keep the instrument in the best possible condition.

Safety Symbols

These safety symbols may appear in this manual or on the instrument.



WARNING

Warning: Identifies conditions or practices that could result in injury or loss of life.



CAUTION

Caution: Identifies conditions or practices that could result in damage to the unit or to other properties.



DANGER High Voltage



Attention Refer to the Manual



Protective Conductor Terminal



Earth (ground) Terminal



Do not dispose electronic equipment as unsorted municipal waste. Please use a separate collection facility or contact the supplier from which this instrument was purchased.

Safety Guidelines

General Guideline • Do not place any heavy object on the PLR.



CAUTION

- Avoid severe impact or rough handling that leads to damaging the PLR
- Do not discharge static electricity to the instrument.
- Use only mating connectors, not bare wires, for the terminals.
- Do not block the cooling fan opening.
- Do not disassemble or remove the case covers of the PLR unless you are qualified.
- Do not insert foreign objects into the unit.
- Do not use the unit when smoke or fire or other abnormal behavior is seen. Turn the unit off immediately.
- Calibration: It is recommended that the unit is calibrated periodically.
- Do not exceed the maximum input as defined in the specifications.

(Measurement categories) EN 61010-1:2010 and EN 61010-2-030 specify the measurement categories and their requirements as follows. The PLR falls under category II.

- Measurement category IV is for measurement performed at the source of low-voltage installation.
- Measurement category III is for measurement performed in the building installation.
- Measurement category II is for measurement performed on the circuits directly connected to the low voltage installation.
- 0 is for measurements performed on circuits not directly connected to Mains.

Power Supply



WARNING

- AC Input voltage range: 100VAC to 240VAC
 - Frequency: 50 to 60Hz
 - To avoid electrical shock connect the protective grounding conductor of the AC power cord to an earth ground.
-

Cleaning the Unit

- Disconnect the power cord before cleaning.
 - Use a soft cloth dampened in a solution of mild detergent and water. Do not spray any liquid.
 - Do not use chemicals containing harsh material such as benzene, toluene, xylene, and acetone.
-

Operation Environment

- Location: Indoor, no direct sunlight, dust free, non-corrosive, non-flammable, almost non-conductive pollution (Note below)
- Relative Humidity: 30%~ 85% (No dew condensation)
- Altitude: < 2000m
- Temperature: 0°C to 40°C

(Pollution Degree) EN 61010-1:2010 and EN 61010-2-030 specify the pollution degrees and their requirements as follows. The PLR falls under degree 2.

Pollution refers to “addition of foreign matter, solid, liquid, or gaseous (ionized gases), that may produce a reduction of dielectric strength or surface resistivity”.

- Pollution degree 1: No pollution or only dry, non-conductive pollution occurs. The pollution has no influence.
 - Pollution degree 2: Normally only non-conductive pollution occurs. Occasionally, however, a temporary conductivity caused by condensation must be expected.
 - Pollution degree 3: Conductive pollution occurs, or dry, non-conductive pollution occurs which becomes conductive due to condensation which is expected. In such conditions, equipment is normally protected against exposure to direct sunlight, precipitation, and full wind pressure, but neither temperature nor humidity is controlled.
-

Storage environment

- Location: Indoor
 - Temperature: -20°C to 60°C
 - Relative Humidity: 20% to 85% (No dew condensation)
-

Disposal



Do not dispose this instrument as unsorted municipal waste. Please use a separate collection facility or contact the supplier from which this instrument was purchased. Please make sure discarded electrical waste is properly recycled to reduce environmental impact.

Power cord for the United Kingdom

When using the power supply in the United Kingdom, make sure the power cord meets the following safety instructions.

NOTE: This lead/appliance must only be wired by competent persons



WARNING: THIS APPLIANCE MUST BE EARTHED

IMPORTANT: The wires in this lead are coloured in accordance with the following code:

Green/ Yellow:	Earth
Blue:	Neutral
Brown:	Live (Phase)



As the colours of the wires in main leads may not correspond with the coloured marking identified in your plug/appliance, proceed as follows:

The wire which is coloured Green & Yellow must be connected to the Earth terminal marked with either the letter E, the earth symbol \oplus or coloured Green/Green & Yellow.

The wire which is coloured Blue must be connected to the terminal which is marked with the letter N or coloured Blue or Black.

The wire which is coloured Brown must be connected to the terminal marked with the letter L or P or coloured Brown or Red.

If in doubt, consult the instructions provided with the equipment or contact the supplier.

This cable/appliance should be protected by a suitably rated and approved HBC mains fuse: refer to the rating information on the equipment and/or user instructions for details. As a guide, a cable of 0.75mm² should be protected by a 3A or 5A fuse. Larger conductors would normally require 13A types, depending on the connection method used.

Any exposed wiring from a cable, plug or connection that is engaged in a live socket is extremely hazardous. If a cable or plug is deemed hazardous, turn off the mains power and remove the cable, any fuses and fuse assemblies. All hazardous wiring must be immediately destroyed and replaced in accordance to the above standard.

PLR SERIES

About this Manual

This manual applies to the following PLR series power supply units and optional interface units.

Model name	Rated Voltage	Rated Current	Rated Power
PLR 20-18	20V	18A	360W
PLR 36-10	36V	10A	360W
PLR 60-6	60V	6A	360W
PLR 20-36	20V	36A	720W
PLR 36-20	36V	20A	720W
PLR 60-12	60V	12A	720W

Standard Interface unit for the PLR series.

PLR-RS	RS-232C Interface.
--------	--------------------

Optional Interface units for the PLR series.

PLR-GU	GPIB/USB Interface
--------	--------------------

PLR-LU	LAN/USB Interface
--------	-------------------

PLR-ARC	Analog Remote Control Interface
---------	---------------------------------

Outline of Product

The PLR series are small, lightweight, switching type and dropper type, regulated DC power supply units with low noise. Because the PLR series power supply units are highly reliable and have a variety of protective functions, they are ideally suited for industrial use, such as for performing reliability tests, durability tests, and age-testing electronic components.

The PLR series offer a variety of functions for a variety of applications: preset functions (3 setting points); protective functions against output overvoltage, under voltage and overcurrent; output discharge circuit/cancel function; output off timer function; CC priority mode while the output is on; sequence function; and operation by external analog signal.

There are 3 types of optional interface boards, PLR-GU, PLR-LU and PLR-ARC. These boards replace the standard board equipped with the unit (PLR-RS), and provide communication functions.

Features

PLR Power Supply Unit

- **Low ripple and low noise**
The PLR power supply units reduce output ripple and output noise with a series transistor for output voltage.
- **Select the setting digits for voltage and current**
The output voltage and current are indicated by 4 digits. You can select a digit to set the voltage and the current. The PLR power supply unit is also equipped with a fine adjustment function for instances in which more precise setting capabilities are required.
- **Preset function**
The unit has 3 preset memory points in which different voltage and current settings can be stored. This function enables you to

easily change the voltage and current settings.

- **Output off timer function**

To prevent battery overcharge and similar problems, this function automatically turns the output off after a preset amount of time has passed while the output is on.

- **CC priority mode**

Compared to general switching power supply units, the PLR power supply unit is better able to reduce current overshoot, thanks to our original current-overshoot inhibit circuit. This circuit produces a load that enables the unit to operate at a constant current while the output is on.

- **Sequence function**

Sequence programs can be written to the unit from a computer via the interface boards (PLR-RS, PLR-GU and PLR-LU).

Sequence programs can be executed by performing panel or computer operations. You can also perform sequence operations with a maximum of 1000 steps by using a program written by the computer. The minimum step unit is 50ms.

- **Remote sensing function**

This function uses the remote sensing terminal to compensate for voltage drop caused by the wires.

- **Protective functions**

The PLR power supply unit has protective functions against overvoltage, under voltage and overcurrent for the primary side, and overvoltage, overcurrent, remote sensing (terminal open), and internal heat for the secondary side. The unit is also equipped with OVP (over-voltage protection), UVP (under-voltage protection), and OCP (over-current protection) for the load. The setting values for these protective functions are changeable.

- **Master-slave operation**

The PLR power supply unit can perform master-slave operation. Master-slave operation can be performed with a maximum of 3 units (of the same voltage model) connected in parallel, and with

a maximum of 2 units (of the same model) connected in series.

- **External analog signal operation**

When setting the voltage and current by external voltage and resistance, the setting values set externally will be superimposed on the setting values set on the panel. The external setting values can be adjusted on the panel. The output can be turned on and off by an external contact switch.

- **Dispersion circuit for rush current prevention**

The PLR power supply unit is able to restrain and minimize the primary side current and voltage distortions caused by rush current on the primary side at the time the unit is switched on, thanks to the main relay's on/off operation and our original dispersion circuit for rush current prevention.

- **Power factor correction circuit, as well as voltage and current range for worldwide use**

The PLR power supply unit is equipped with a power factor correction circuit that has a rated output of approximately 0.99. It is operable with supply voltages ranging from 100VAC to 240VAC, without changing the settings.

- **CE Marked**

The PLR power supply unit conforms to CE marking (under voltage directive, EMC directive). It also complies with the regulations for the harmonic current of power supply units.

PLR-RS

- Units equipped with the PLR-RS can be connected to a computer and controlled by RS-232C. PLR-RS can also control 31 PLR power supply units via a local bus connection.

PLR-GU (option)

- PLR-GU is connected to a computer through a GP-IB or USB. Fourteen units may be connected with a computer through GP-IB, or 32 units may be connected through USB.
- Units connected to the computer can be connected with 31 PLR power supply units via a local bus connection.

PLR-LU (option)

- PLR-LU is connected to a computer through a LAN or USB. 32 units may be connected through USB.
- Units connected to the computer can be connected with 31 PLR power supply units via a local bus connection.

Cable for master-slave operation (option)

- Cable for parallel master-slave
PLR-001 : Connectable with three PLR power supply units.
 - Cable for in-series master-slave
PLR-002 : Connectable with two PLR power supply units.
-



**CAUTION**

When connecting cables, make sure to connect the correct cables.

Connecting the wrong cables may cause product failure.

Prior to Use

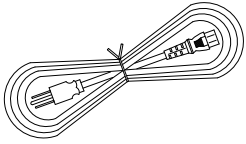
Standard Accessories

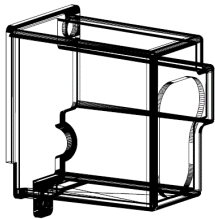
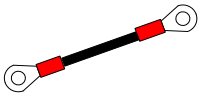
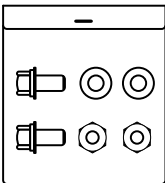
Item	Description
1	<p>Power cable: 14AWG, 15A, 2M</p>  <p>Power cable: 1 pc</p>
2	<p>CD-ROM: User Manual</p>  <p>1 pc</p>
3	<p>Rear output terminal cover See page 19 for details.</p>  <p>1 pc</p>
4	<p>Output grounding cable See page 17 for details.</p>  <p>1 pc</p>
5	<p>Bolt set Contents: Hexagon head bolt (P-3): 2 pcs Flat washer: 2 pcs Hexagon nut: 2 pcs See page 16 Connect to the Output Terminals for details.</p>  <p>1 pkt</p>

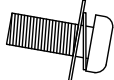
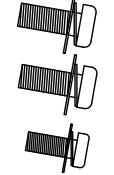
6	<p>M3 Small screw washer: 1 set (For attaching the grounding cable to one of the rear output terminals.)</p> <p>See page 17 for details.</p>	
7	<p>M3 Large screw washer: 2 sets (For attaching the rear output terminal cover.)</p> <p>See page 19 for details.</p>	
8	<p>M4 Small screw washer: 1 set (For Connecting the protective grounding terminal on the bottom face)</p> <p>See page 22 for details.</p>	
9	<p>PLR-RS: RS-232C Interface Card (Attached to power supply)</p>	

Optional Accessories

Part number	Description
PLR-ARC	Analog Remote Control Interface Card
PLR-GU	GPIB/USB Interface Card
PLR-LU	LAN/USB Interface Card
PLR-001	Parallel Connection Signal Cable (2 to 3 units)
PLR-002	Series Connection Signal Cable
GRJ-1101	Modular Cable (0.5m)
GRJ-1102	Modular Cable (1.5m)
GRA-427	Rack mount adapter

Connect the Power Cable

The power cable should be connected to an AC inlet or an input terminal block.



Warning

Make sure to properly connect the power cable. Failure to do so may result in electric shock or fire.

Using the unit without the AC input terminal cover may result in electric shock or fire.

Perform this operation before connecting the power cable to an AC outlet or the distribution panel.

Connect to the Output Terminals

Use the supplied bolt set to connect the load cable to the rear output terminals. Adjust the tightening torque of each bolt to 25 kgf/cm.

Check the connection between the load and the output terminals of the unit. Make sure that the polarity is not inverted, and that no short circuits have occurred.

Steps

1. Attach a round crimp-style terminal (inner diameter of at least 6.4 mm) to the load cable.
2. Insert the bolt into the hole from left side of the output terminal.
3. From the right side of the output terminal, first attach the load cable (with the round crimp-style terminal attached), followed by the washer and then the nut. Finally, secure the bolt.

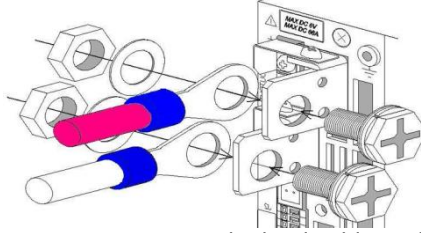

Fig. 2-2 Connecting the load cable to the rear output terminals



Warning

Make sure the voltage of the unit's output terminals has sufficiently fallen before touching and operating the load or output terminals. Failure to do so may result in electric shock.

Attaching the Output Grounding Cable

You do not need to perform this operation if the output is not to be grounded.

Use the M3 Small screw w/washer to attach the grounding cable to one of the rear output terminals.

Tightening torque of screw: 5kgf/cm.

Steps

1. From the left side of the rear output terminals, attach the grounding cable to the M3 hole of one of the output terminals.
2. Attach the grounding cable to either the positive output terminal or the negative output terminal. Do not attach the cable to both.
3. If you attach the grounding cable to both the positive and negative output terminals, the unit output will short circuit.

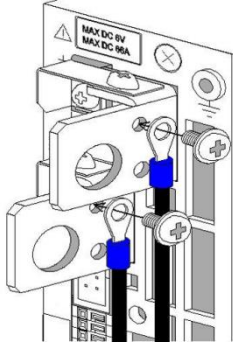

Connecting the voltage remote sensing cables

You only need to perform this operation if you plan to use the voltage remote sensing function of the unit.

Use the removed M3 screws to attach the voltage remote sensing cables to the voltage remote sensing terminals.

Tightening torque of screw: 5kgf/cm

Carefully store the positive and negative shorting bars and the two M3 screws that were removed.

- Steps
1. Remove the M3 screws (4 screws) from the positive and negative rear output terminals and the positive and negative voltage remote sensing terminals, and then remove the positive and negative shorting bars.
 2. Attach the positive and negative voltage remote sensing cables to the positive and negative voltage remote sensing terminals.

3. Attach a round crimp-style terminal (inner diameter of at least 3.2mm, with the smallest possible outer diameter) to the voltage remote sensing cables.

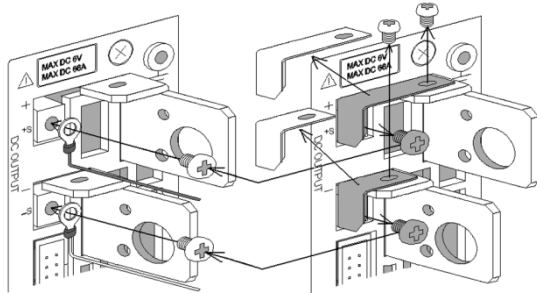

Attaching the rear output terminal cover

The rear output terminal cover should always be attached even when rear output terminals of the unit are not in use.

Use the M3 Large screw with washer to attach the rear output terminal cover.

Tightening torque of screw: 5kgf/cm.

Steps

1. Run the load cable and the voltage remote sensing cable through the output terminal cover, and then fix the output terminal cover to the unit, using the two large screws with washers.
2. Fix the output grounding cable to the output grounding terminal, together with the output terminal cover.

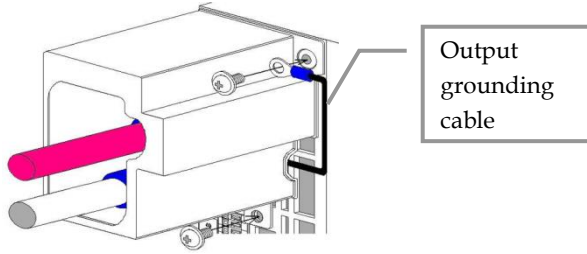

Caution on Connecting to a Capacitive Load

To maintain an output voltage of approximately 0 V when the output is off, the unit is equipped with a discharge circuit for removing the electric charge from the output capacitor.

When the output is off, it takes approximately 1 second for the discharge circuit to remove the electric charge from the output capacitor when the capacitor is fully charged to its rated voltage.

If a capacitive load, such as a battery or capacitor, is connected to the unit and used, it takes longer to lower the output voltage when the output is off. If the output is turned off while a capacitive load is connected, be sure to use a voltmeter to confirm that the voltage has sufficiently fallen before touching the output terminal or the load.

The discharge circuit for the output capacitor does not work if the unit's output HI-R function is used.

Compared to when the output HI-R function is not used, it takes longer for voltage to fall when a capacitive load is used.

Connecting the protective grounding terminal on the bottom face

There is a protective grounding terminal on the bottom face of this unit.

To ensure the safe use of this product, follow the procedure below to connect the protective grounding terminal.

Steps

1. Attach the wire (recommended by the manufacturer) for round crimp-style terminals V1.25-M4 (JST) or equivalent.
2. Attach the round crimp-style terminal to the cable.
3. Attach the cable with round crimp-style terminal to the protective grounding terminal on the bottom face of the unit, using the accessory M4 screw for the grounding connection to secure the cable.

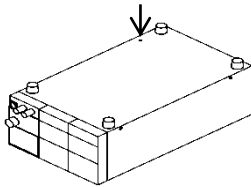

Make sure to properly connect the protective grounding terminal on the bottom face. Failure to do so may result in electric shock. If you do not connect the protective grounding terminal on the bottom face, it will not conform to the CE conformity.

Caution on mounting the unit in a rack

When mounting the unit in a rack, use one of the following attachments:

- Rack mount adapter GRA-427 (for JIS rack)
- GRA-427 (for EIA rack)

When mounting the unit in a rack, replace the screws on the left and right sides of the unit (two on each side) with the flat countersunk head screws.

When mounting the unit in a rack, remove the screw for the protective grounding terminal on the bottom face of the unit. For your own safety, make sure to securely connect the rack to the ground before using the unit.

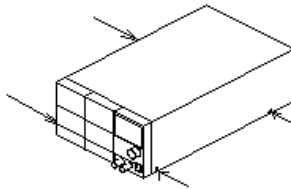

Connecting the Power Cable to the Primary Power

Be sure to turn off the power switch before connecting the power cable to the AC outlet or distribution panel.

Be sure to plug the supplied power cable into an AC outlet with earth ground.



Warning

Plugging the power cable into an outlet or distribution panel that is not properly grounded may result in electric shock or fire. Be sure to ask a qualified engineer to connect the power cable to the distribution panel.

Installation Environment

If the unit is used in a hot place and the internal temperature of the unit rises, the built-in overheat protection circuit activates and turns off the output. Do not use the unit in a location where the grill in the front panel or air outlet port in the rear panel is blocked. Blocking these ports will cause the internal temperature to rise. Maintain sufficient distance between these ports and objects. In some conditions, hot air may blow out of the air outlet port in the rear panel.

Be careful

- Do not use the PLR power supply unit in a place with a lot of dust or corrosive gas. These substances can cause the product to deteriorate.
- Do not use the unit on an incline or a place subject to vibration. Doing so can cause the unit to fall off the rack or fall over, which may result in damage to the unit or personal injury.

PANELS

Front Panel



Front Panel (The above figure shows the front panel of the PLR 20-18)

1. Power switch
 - Turns the AC power on (I) and off (O).
 - Do not position the power supply in such a way as to make accessing/operating the power switch difficult.
2. Front output terminals
 - Front output terminals with a current limit of 20A. Use the unit within the current limit

3. Rotary encoder

- Changes the set voltage and current, and is used to set functions.

4. Grill

- Air intake port.
Push up the ▽ mark in the bottom center of the grill to detach the cover when cleaning or replacing the dust filter inside.

5. Rubber shoes

- Detachable.
If the unit is mounted in a rack and the shoes are not needed, they may be removed.

Operation Panel



Operation Panel (The above figure shows the operation panel of the PLR 20-18)

6. Voltage indicator (red LEDs): 4-digit display, unit indication
 - Indicates the set voltage, output voltage, output power, and MENU items.
 - “W” is lit in red when the indicator displays the output power.
7. Current indicator (red LEDs): 4-digit display, unit indication
 - Indicates the set current, output current, output power, and MENU items.
 - “W” is lit in red when the indicator displays the output power.
8. CV/CC LED (green/red)
 - When the output is on, the LED is lit in green when CV is in operation and red when CC is in operation.
 - Turns off when output is off. It blinks red when the CC priority mode is selected.

9. OUTPUT key (red/amber)

Manual operation:

- Lit in red when the output is on.
- Alternately blinks red and amber when the output off timer is set and the output is on.
- Pressing this key turns the output on and off.
- It is not possible to turn the output on and off when the MENU key is lit in green.

Sequence operation:

- If this key is pressed while a sequence manual/automatic operation is being executed, the output will turn off and the sequence will be interrupted.

10. V key (green/amber)

The voltage is set by operating this front panel key:

- Pressing this key causes it to turn off or light in green.
- When this key is lit in green, it is possible to change the blinking digit of the set voltage in the voltage indicator.
- Pressing and holding down this key which switches the voltage display to the power display. Pressing and holding down this key again switches the display back to the voltage display.
- The key is lit in amber when the voltage is set by external analog signals.

11. A key (green/amber)

The current is set by operating this front panel key

- Pressing this key causes it to turn off or light in green.
- When the key is lit in green, it is possible to change the blinking digit of the set current in the current indicator.
- Pressing and holding down this key which switches the current display to the power display. Pressing and holding down this key again switches the display back to the current display.
- The key is lit in amber when the current is set by external analog signals.

12. MENU key (green)

Manual operation:

- Able to operate and confirm the MENU setting or selection when this key is lit in green.
- Unable to configure the MENU setting when the output is on.

Sequence operation:

- This key is lit in green when it is pressed, and the voltage and current indicators display the setting of the sequence steps to be executed.

13. PROTECT key (green)

- Pressing this key when it is turned off sets OVP (over-voltage protection).
- When this key is lit, OVP (over-voltage protection), UVP (under-voltage protection), and OCP (over-current protection) can be selected and set. Press the ESC key to finish setting the protections.

14. CHECK key (green)

Manual operation:

- When this key is lit, the voltage and current indicators display the set voltage and current. When it is not lit, the indicators display the output voltage and current.
- In the power indication, the voltage and current indicators display " - - -".
- Pressing this key displays the output voltage/current and the set voltage/current alternately.
- Operate the MENU key to display the output voltage and current when the output is off.

Sequence operation:

- Changes the voltage and current indicators from the sequence steps to the output voltage and current, and vice versa.
- The sequence steps are displayed when this key is lit, and the output voltage and current are displayed when it is not lit.

15. DIGIT KEY ◀

Manual operation

- Pressing this key moves the digit cursor of the set voltage, current, OVP, UVP, or OCP value to the left.

Sequence operation

- Returns to the previous step while the sequence program is being executed.
- If this key is pressed when execution is stopped, the execution STEP can be set to the START STEP (execution mode: 0 and 1) and the END STEP (execution mode: 2 and 3) in the sequence program.

16. DIGIT KEY ►

Manual operation

- Pressing this key moves the digit cursor of the set voltage, current, OVP, UVP, or OCP value to the right.

Sequence operation

- Moves forward to the next step while the sequence program is being executed.
- If this key is pressed when execution is stopped, the execution STEP can be set to the END STEP (execution mode: 0 and 1) and the START STEP (execution mode: 2 and 3) in the sequence program.

17. ENTER/MEM/STEP key (green/amber)

Manual operation

Memory function:

- Pressing this key causes the PRESET 1, 2, and 3 keys to blink, and places the memory on standby to store the setting.
- Pressing this key again cancels the memory's standby state.

Initialization:

- Pressing and holding down this key then turns power on the unit and initializes the data stored in the unit.

Sequence operation

- This key is lit in green. Pressing this key again causes it to be lit in amber, and the voltage and current indicators display the STEP value.

18. PRESET 1/STOP key (green/amber)

Manual operation

- Stores and reads out the set voltage and current.
- When this key blinks green, it is on standby to store the setting. When it is lit in green, it reads out the data stored in PRESET 1.

Sequence operation

- Lit in amber during the sequence operation. Pressing this key stops the execution of the sequence program.

19. PRESET 2/PAUSE key (green/amber)

Manual operation

- Stores and reads out the set voltage and current.
- When the key blinks green, it is on standby to store the setting. When it is lit green, it reads out the data stored in PRESET 2.

Sequence operation

- Lit in amber during the sequence operation. Pressing this key suspends the execution of the sequence program.

20. PRESET 3/START key (green/amber)

Manual operation

- Stores and reads out the set voltage and current.
- When the key blinks green, it is on standby to store the setting. When it is lit in green, it reads out the data stored in PRESET 3.

Sequence operation

- Lit in amber during the sequence operation. Pressing this key starts the execution of the sequence program.

21. ESC/KEYLOCK LOCK/RMT key (green)

- Lit in green when the unit is in remote operation or key lock state. When this key is lit, the unit cannot be operated from the front panel (although the OUTPUT key can still be operated).
- ESC function: Pressing this key cancels the display of the voltage/current setting, OVP/UVP/OCV setting, MEMORY setting, and MENU setting.
- Pressing and holding this key while it is lit in green cancels remote operation or key lock. After remote operation or key lock is cancelled, the light turns off.
- Pressing and holding this key while the light is off locks the key. After the key is locked it becomes lit in green.

Rear Panel

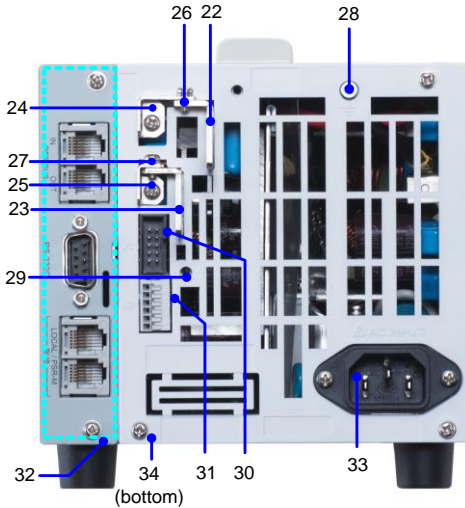

Rear Panel (The above figure shows the rear panel of the PLR 20-18)

22./ 23. Output terminals

- Output terminals of the PLR series power supply unit.
 - 22: Positive output
 - 23: Negative output
- Use the supplied bolt set when connecting to the load cable.
- Voltage is output from the rear output terminals even when the front output terminals are used. Be sure to attach the supplied rear output terminal cover to the unit when the rear output terminals are used.
- The rear output terminal cover should be fixed at the following two points: the output terminal grounding terminal (28) and the output terminal cover attachment hole (29)

24./ 25. Remote sensing terminals

- Remote sensing terminals of the PLR series power supply unit.
 - 24: Positive terminal
 - 25: Negative terminal
- To use the remote sensing function, remove the shorting bars (26 and 27).
- When using the remote sensing function, connect the positive remote sensing terminal (24) to the part where the positive output terminal of the load is connected, and the negative remote sensing terminal (25) to the part where the negative output terminal of the load is connected.

Incorrectly connecting the terminals may damage the unit or apply overvoltage to the load.

26./ 27. Shorting bars

- Short-circuits the output terminals and remote sensing terminals.
 - 26: Positive shorting bar
 - 27: Negative shorting bar
- When the remote sensing function is not used, attach the shorting bars to the output terminals and remote sensing terminals to operate the unit. Failure to securely attach the short bar may cause the output to become unstable.

28. Output grounding terminal

- Used to ground the positive or negative output terminal of the unit.
Use the output ground cable to ground output terminals.
- This terminal is also used to fix the output terminal cover.

29. Output terminal cover attachment hole

- Used to fix the output terminal cover.
Use the supplied M3 large screw with washer.

30. J1 connector

- Used for master-slave operation.
The parallel master-slave cable and series master-slave cable are different. Use the cable appropriate for the operation.



Do not connect any cables other than the master-slave cable.
Connecting other cables may damage the unit.

31. J2 connector

- The connector for the monitor output of the unit output and the slave control signal input for series master-slave operation.
The terminal is a screw-less connector.
Use AWG24 – 26 cables to connect.

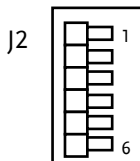

J2 connector's pin no.

No.	Description
1	Output current monitor output: Output current 0A → Rated current approx. 0V → Output 10V.
2	Output voltage monitor output: Output voltage 0V → Rated voltage approx. 0V → Output 10V.
3	Common terminal for 1 and 2. The terminal is connected to the negative output terminal.
4	When the unit is used as the slave machine for series master-slave operation, connect to the negative output terminal of the master machine.
5, 6	Not used. Do not connect anything to these terminals because they are for internal connection.

32. Interface slot

- An analog signal control unit (hereinafter standard board) is equipped as standard.
- The standard board can be replaced with an interface board (hereinafter PLR board) that controls the unit via external signals.

Remove the two upper and lower screws from the marked area to install the PLR board. Make sure to refasten the two upper and lower screws after installing the board.

If the upper and lower screws are not fastened, contact failure between the unit and PLR board may cause the unit to malfunction.

33. AC inlet

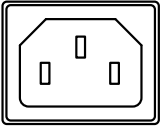

AC input terminal block

- Use the supplied power cable. Connect the power cable to the AC inlet.

AC INLET



Supplying AC power to the unit that exceeds the specified input range may result in failure, electric shock, or fire.

Performing wiring work while the power cable is connected to the AC outlet or distribution panel may result in electric shock or fire.



For optimal air ventilation, maintain a distance of at least 30cm between the rear panel and nearby objects.

If the rear panel is blocked, the internal temperature may rise.

34.  Protective grounding terminal

The product is equipped with a protective grounding terminal on the bottom face. For your own safety, make sure to connect the unit to ground before use.

See page 22 for details.



Make sure to properly connect the protective grounding terminal on the bottom face.

Failure to do so may result in electric shock.

If you do not connect the protective grounding terminal on the bottom face, it will no longer conform with the CE conformity.

GENERAL

INSTRUCTIONS

Connecting loads

- When connecting loads to the unit, use round crimp-style terminals, etc. to ensure loads are securely connected to the output terminals.
- Use cables that have sufficient current capacity for the wiring to be connected.
- Be sure to turn off the unit (output off) before connecting or disconnecting cables to and from the wiring.
- The unit is equipped with a capacitor of several thousands of μF that is connected to output terminals, and a circuit for discharging the charged capacitor while the unit is turned off (output off).

The unit also features the HI-R function for cutting off the discharge circuit. However, low-ampere current flows through the circuit of the voltage monitor, etc. When the battery is charged and the unit is turned off (output off), the low-ampere current causes the voltage of the battery to fall.

When the unit is used for charging batteries or a similar purpose, to prevent the load from discharging to the unit, connect a diode in series to the load, as shown in the figure, "Connecting a load with energy".

Connection

Connect a diode that meets the following conditions:

- It must have sufficient reverse voltage resistance against the rated voltage of the unit.
- It must have sufficient forward current capacity against the rated current of the unit.
- Take proper measures for the radiating heat generated by the elements.

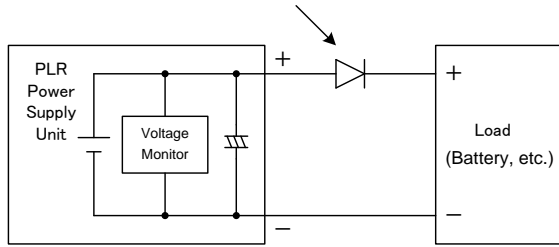

Connecting a load with energy

Current capacity of a load cable

The cable used as a load cable must have sufficient current capacity against the rated output current of the unit

Installation

AWG	Sectional Area mm ²	Recommended A
14	2	10
1	38	100
3/0	80	200

(Reference values at an ambient temperature of 30°C.)

Alarm

Background The hardware detects abnormal states and displays “AC oFF” or “ALII” on the voltage and current indicators.

Alarm Causes	Cause	Recoverable
1	Over input voltage: Supply voltage of 270VAC or greater.	No
2	Under input voltage: Supply voltage of 80VAC or less.	No
3	Wrong number of power units used in parallel master-slave operation.	No
4	Front output over current: Current from the front output is 30A or greater.	Yes
5	Internal overheat: Internal heat sink temperature of approx. 110°C or higher	Yes
6	Over output voltage: 115% of maximum voltage or greater.	Yes
7	Over output current: 115% of maximum current or greater.	Yes

Unrecoverable alarm

If the voltage and current indicators display “AC OFF” and then “ALII”, and the power switch has not been turned off, there may be a unit malfunction. Perform the following steps:

1. Turn off the power switch.
2. Disconnect the power cable from the AC outlet or distribution panel.
3. Check whether any of the causes described in 1 through 3 have occurred.

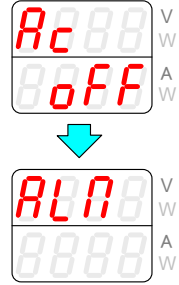

Recoverable Alarm

If the voltage indicator displays “ALII”, and the ESC key is lit in green, press the ESC key.

This makes it possible to turn the power of the unit on or off.

4. Check whether any of the causes described in 4 through 7 have occurred.
5. If the cause of the alarm was one of the causes described in 5 through 7, the unit may need to be repaired or recalibrated.

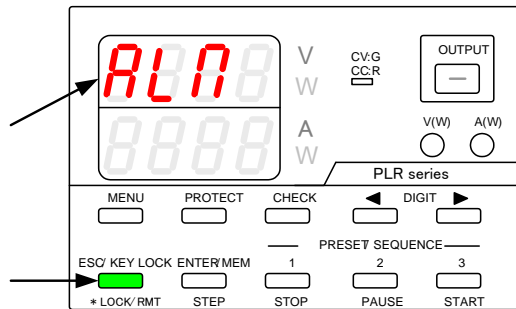

FUNCTIONS AND OPERATION PROCEDURES

Operation modes

The unit has four basic operation modes, which are as follows:

Operation Mode	Description
Manual mode	Manual operating the unit using the panel.
Sequence mode	Setting changes over time according to the sequence program stored in the internal memory.
External analog control	Operating the unit via the external analog signals and ON/OFF signal.
External digital control	Operating the unit via an external communication device.

Turning on Power

Display when power is turned on

Properly connect the AC power cable of the PLR power supply unit, confirm that power is being supplied, and then turn on the power switch. The following characters are displayed on the voltage and current indicators until the unit is ready for normal operation.



These characters are displayed after the power switch is turned on.



The rated voltage is displayed in the upper row, and the rated current in the lower row. (The

rating is displayed while the internal test is performed.)



The software version is displayed.



When using a parallel connection, the version is displayed for 2 seconds. The display then switches to the unit scan window.



The unit can be operated.

Manual mode.

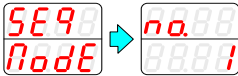

The unit can be operated to sequence mode.

After displaying the seq mode, step No. is displayed.

Performing a unit scan while using a parallel connection

When a parallel connection is set up, the master unit checks the operation status of the slave units.

The voltage and current indicators display the following messages until the unit enters normal operation status.

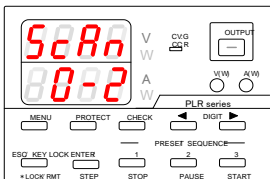

When a scan is performed while a parallel connection is being used, the word "ScAn" is displayed on the voltage indicator. The scanning status is displayed on the current indicator.

In the figure to the left, "0" indicates the number of scanned units, and "2" indicates the number of registered units in the parallel connection.

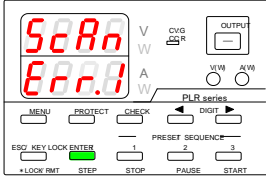

If the unit detects a number other than the number of registered units, an error message is displayed, as shown in the figure on the left.

The final digit of the current indicator indicates the number of units detected, including the master unit.

In the figure to the left, the number listed in the error message is "1". This number indicates that the master unit was detected, but no slave units.

If this error message is displayed, check the settings and wiring, and then restart the power supply unit.

Recalling Settings When Turning on Power, and Saving the Setting Data

Manual mode	Initial setting
Sequence mode	Off
Preset data recalled when power is Last turned on	
Output Off display	Set value
Output On setting when power is Off turned on	
Master-slave	Single-unit operation
CC priority output	Off
Output Off timer	0 min.
Setting cancellation time	3 min.
Set OVP	Maximum

Set UVP	Minimum
Set OCP	Maximum
Set voltage (including stored Preset voltages)	0V
Set current (including stored Preset currents)	0A
System address	1
PC address	1

Sequence mode	Initial setting
Set voltage for each step	0V
Set current for each step	0A
Output for each step	Off
OVP for each step	Maximum
UVP for each step	Minimum
OCP for each step	Maximum
Execution time for each step	00h00m00s000
Pause operation for each step	OFF
Output HI-R setting for each step	OFF
Start step	1
End step	1000
Number of repeating programs	1
Execution mode	0

※ A battery cell is not used to store setting data.

Basic Operation

Voltage setting procedure

Operation procedure

1. Press the V key, which is then lit in green. One of the voltage setting digits starts blinking. Only the digit that is blinking can be modified.
2. Press one of the DIGIT keys ◀▶ to move to another digit and make it blink.
3. Use the setting rotary encoder to set the voltage value.
4. Press the V key to exit the setting mode.

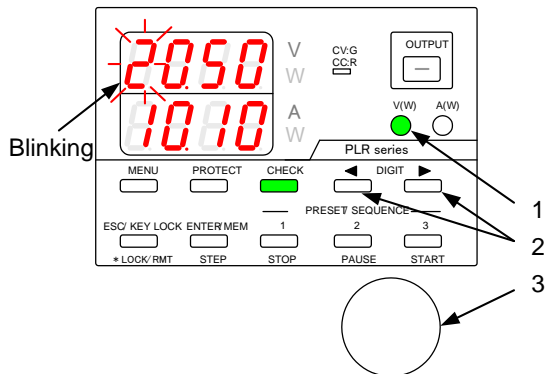

Current setting procedure

Operation procedure

1. Press the A key, which is then lit in green. One of the current setting digits starts blinking. Only the digit that is blinking can be modified.
2. Press one of the DIGIT keys ◀▶ to move to another digit and make it blink.
3. Use the setting rotary encoder to set the current value.
4. Press the A key to exit the setting mode.

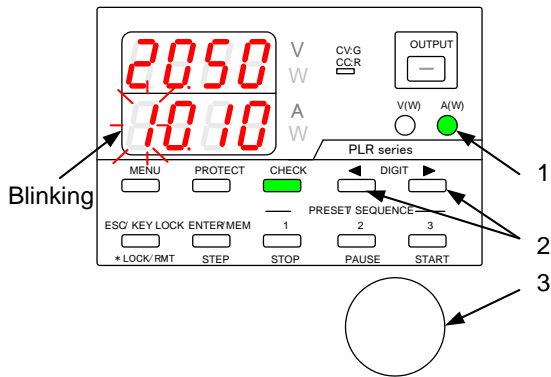

Fine adjustment of voltage/current

- | | |
|---------------------|---|
| Function | Fine-adjusting the output voltage/current to a digit lower than the displayed digits. |
| Operation procedure | <ol style="list-style-type: none"> 1. Confirm that the rightmost digit is blinking, and press the DIGIT key ► to move the modifiable digit to the right.

The rightmost digit stops blinking and then remains lit. 2. With the rightmost digit lit, turn the setting rotary encoder to adjust the voltage/current to one digit lower than the lowest displayed digit.

The digit lower than the displayed digit is not visible. You must connect an external device to confirm the actual output. Note that the amount of change made by one click of the rotary encoder might differ by model. |

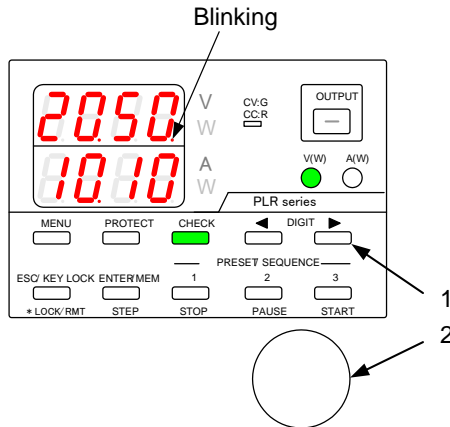

The setting accuracy in SPECIFICATIONS is not guaranteed for fine adjustment.

Output Functions

Operation Procedure

1. Press the unlit OUTPUT key, which is then lit in red. After this key is lit, voltage is output.
2. Press the red-lit OUTPUT key. The light goes out, and the voltage output is turned off.

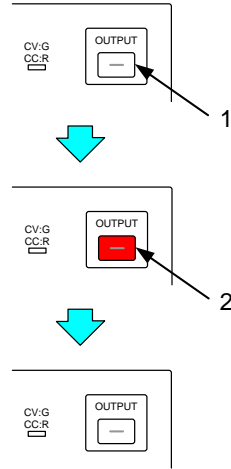

CAUTION

Make sure the wires are connected to the output terminals before turning the output on.

Memory Function

Storing and recalling preset voltage/current data

Storing preset data

Operation
procedure

1. Set the voltage and current values, following the steps described in “Voltage setting procedure” (page 47) and “Current setting procedure” (page 48).

Press the ENTER/MEM key.

PRESET keys 1 to 3 all blink green.

2. Press the PRESET key (1, 2, or 3) where you want to store the set value.

The PRESET key that you pressed will be lit in green. The voltage and current values are stored in the selected PRESET key.

※ To cancel storing the set values, press the ENTER/MEM key again while PRESET keys 1 to 3 are all blinking green.

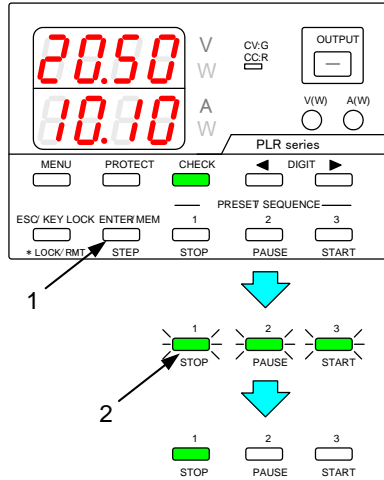

Recalling preset data

Operation procedure

1. Press a PRESET key (1, 2, or 3) to recall the voltage and current values stored in that key.

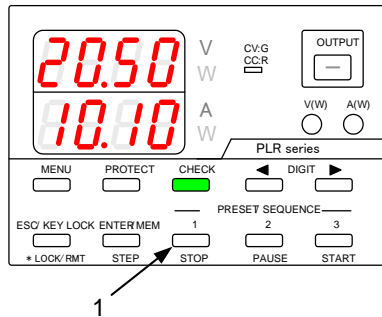

Switching the display in the Voltage/Current Indicator Display

Switching between the set voltage/current display and output voltage/current display

Operation procedure

When the CHECK key is lit in green, the set voltage and current are displayed.

When the CHECK key is unlit, the output voltage and current are displayed.

When the output is off, the CHECK key remains lit in green. (No CHECK key operations can be performed.)

When the OUTPUT key is pressed and then lit in red (turning the output on), the CHECK key light goes out.

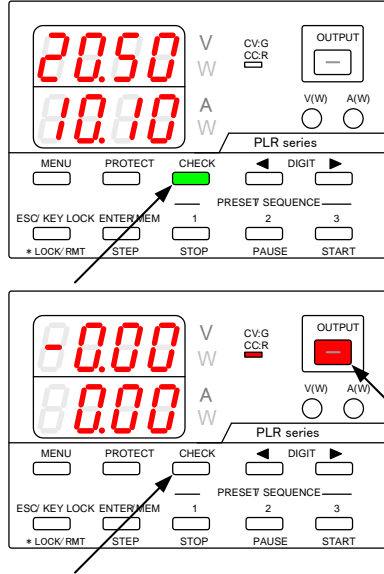

Displaying output power in the voltage indicator

Operation procedure

1. When voltage is displayed, press and hold the V key to display the output power.

When the output is off, the output power is displayed as “- - - -”.

Press and hold the unlit V key to display the voltage again.

2. Press the OUTPUT key to display the output power.

Functions and Operation Procedures

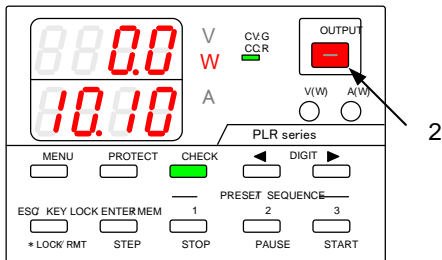
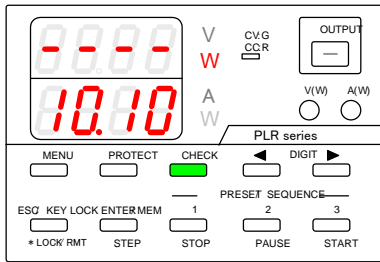
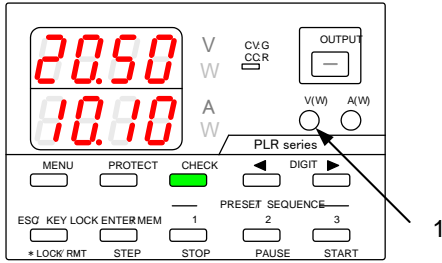

Displaying output power in the current indicator

Operation
procedure

1. When current is displayed, press and hold the A key to display the output power.

When the output is off, the output power is displayed as “— — — —”.

Press and hold the unlit A key to display the current again.

2. Press the OUTPUT key to display the output power.

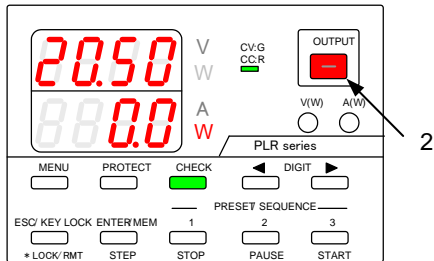
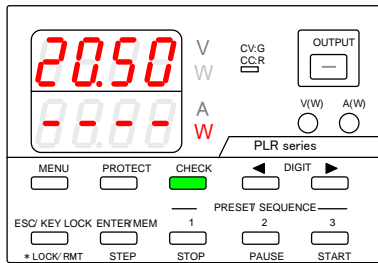
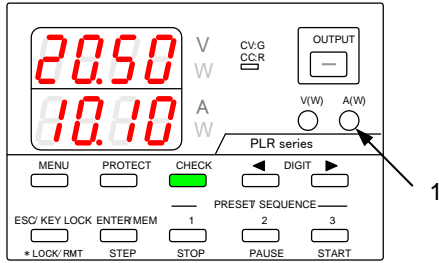

When the V and A keys are lit, the display cannot be switched to the output power display.

Protective Functions

The PLR power supply unit has 3 different protective functions (OVP, UVP, and OCP). Set the value for each of the protective functions to fit the intended use of the unit.

Function	Description
OVP	Turns the output off when the output voltage exceeds the set voltage for OVP.
UVP	Turns the output off when the output voltage falls below the set voltage for UVP.
OCP	Turns the output off when the output current exceeds the set current for OCP.

For the UVP and OCP functions, the software detects output voltage and current and turns the output off if needed.

Display output when protective functions are activated

OVP (Overvoltage protection)

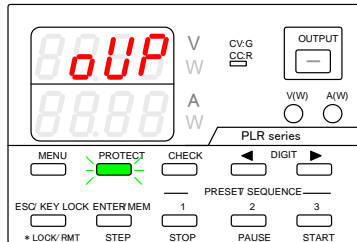

UVP (Undervoltage protection)

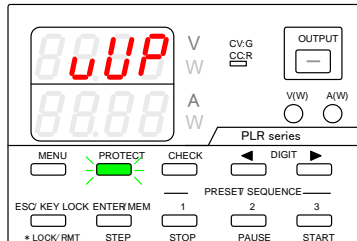

OCP
(Overcurrent
protection)

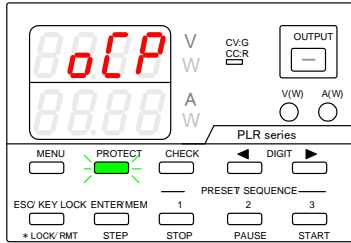

Modification of the Protective Function Settings

When modifying the protective function settings, press the PROTECT key and select the protective function to be modified. Modify the set values by using the DIGIT keys ◀ ▶ and the rotary encoder.

Operation
procedure

1. Press the PROTECT key, which is then lit in green. The protective function type is displayed in the current indicator, and the modifiable digit blinks in the voltage indicator.
2. Press the DIGIT keys ◀ ▶ to select the digit to be modified. Only the digit that is blinking can be modified.
3. Use the rotary encoder to modify the set value.
4. After setting the protective function, press the blinking ESC/KEY LOCK key to store the set value of the protective function.

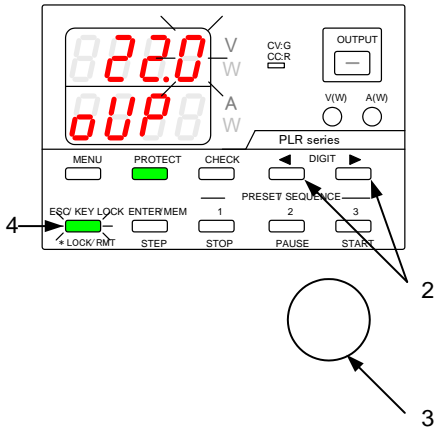
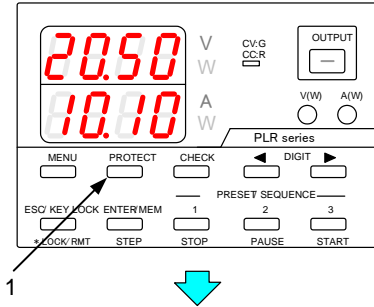

Press the green-lit PROTECT key to change the display. The display changes in the following order: OVP setting → UVP setting → OCP setting.



Deactivating Protective Functions

When some protective functions are activated, it is displayed and the output is turned off.

Operation procedure

1. When the activated protection is displayed, press the PROTECT key, which is blinking green, to deactivate the protective function.

After deactivating the protective function, the unit can be operated while the output is off.

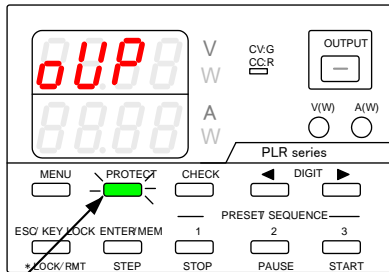

Key Lock/Local Function

Status	Non-operational keys
KEY LOCK	All keys, excluding the ESC/KEY LOCK key, OUTPUT key (only when turning the output off), and the rotary encoder.
REMOTE	All keys, excluding the ESC/KEY LOCK key and rotary encoder.

Key lock and unlock procedures

Key lock procedure

Operation

1. When the MENU key and the PROTECT key are unlit, press and hold the ESC/KEY LOCK key, which is then lit in green.

This activates the key lock. After the key lock is activated, you cannot operate the keys and the rotary encoder.

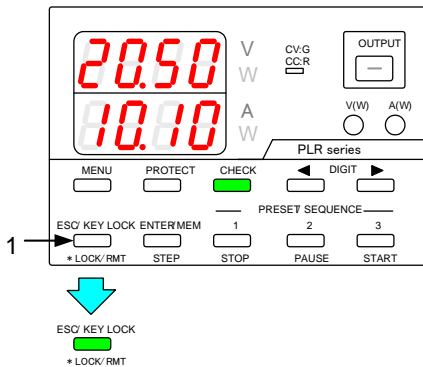

Key unlock procedure

- Operation
1. Press and hold the green-lit ESC/KEY LOCK key. The light then goes out.

This deactivates the key lock. After the key lock is deactivated, you can operate the keys and the rotary encoder.

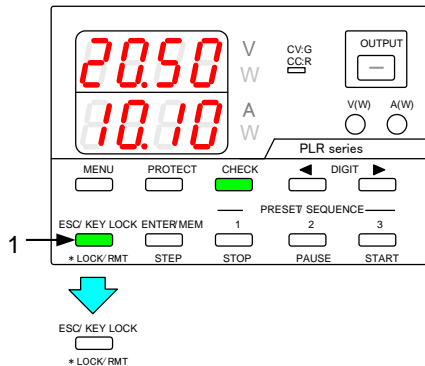

While key lock is activated, the output can be turned off.
However, if the output is already off, it cannot be turned on.

Remote mode deactivation procedure

- Operation procedure
1. When the unit is operated via external digital control, the ESC/KEY LOCK key is lit in green and the unit is remotely controlled.

When the unit is remotely controlled, you cannot operate the keys and the rotary encoder.

Press and hold the green-lit ESC/KEY LOCK key. The light then goes out.

This returns the unit to local mode. You can operate the keys and the rotary encoder after the unit returns to local mode.

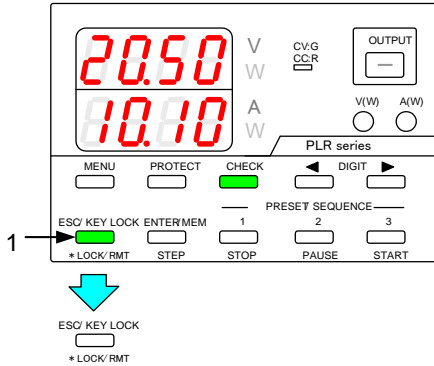

Even if the unit is in local mode, it returns to remote mode when it is operated via external digital control.

MENU KEY SETTINGS

The following items can be set by using the MENU key:

Setting item	Explanation in the manual	Page
Setting the output off timer	This function is used to automatically turn off the output after a preset amount of time has passed since the output was turned on. Setting the output off timer	68
Specifying the automatic cancellation time of the setting menu display	Specifies the amount of time before the setting menu display is automatically cancelled for each setting menu	72
Confirming that the output is off	Checking the status when the output is off	154
Confirming the interface card mode	Checking the mode and address settings of the interface card	169

Push the MENU key to change the display. Items with no assigned functions are skipped.

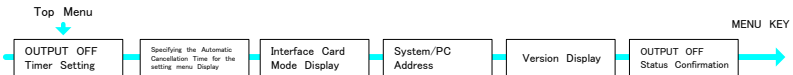

The following items can be set when turning on the power switch while pressing and holding the MENU key:

Setting item	Explanation in the manual	Page
Recalling preset values when the power is turned on	Recalling preset data	52
Setting the output when the power is turned on	Setting the output when the power is turned on	76
Setting the CC priority mode	Setting the CC priority mode	79
Setting the display while the output is off	Setting the display while the output is off	83
Configuring the master and slave units	Configuration of Master and Slave Units	01
Sequence operation settings	Sequence Operation	112
Address settings	Address settings	66
RS-232C communication speed setting	RS-232C communication speed setting	88
Specifying power relay ON/OFF	Default setting of power relay when the power is turned on	86

Push the MENU key to change the display. Items with no assigned functions are skipped.

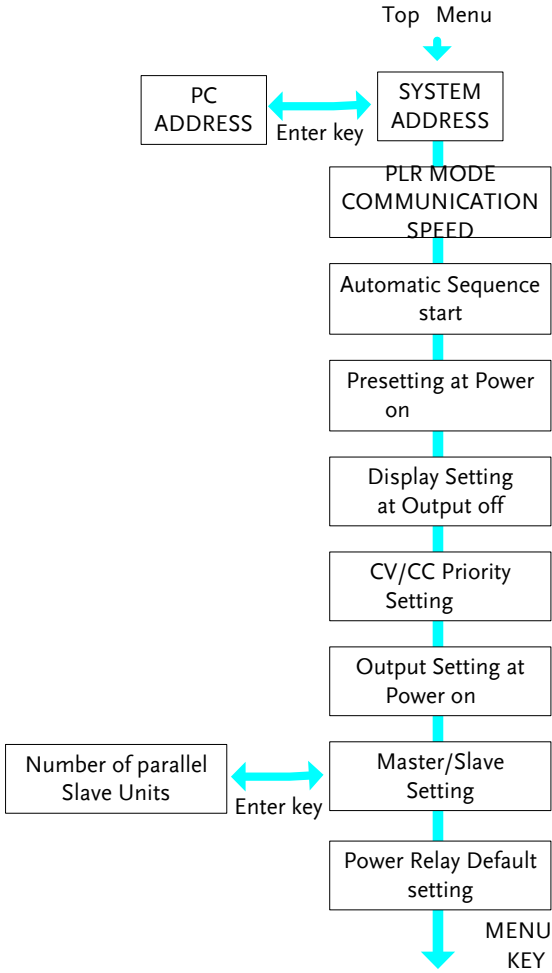

The following items can be set when turning on the power switch while pressing and holding the ENTER/MEM key:

Setting item	Explanation in the manual	Page
Memory Clear	Clearing the Memory	91

Output Off Timers

This function is used to automatically turn off the output after a preset amount of time has passed since the output was turned on.

Setting the output off timer

Operation procedure

1. Turn the output off, then repeatedly press the MENU key until the current indicator displays “* *.oF” .

The MENU key is then lit in green, and the ESC/KEY LOCK key and the ENTER/MEM key start blinking green.

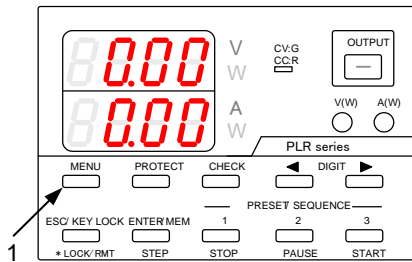

2. Press the DIGIT keys ◀ ▶ to select the digit to be modified. Only the digit that is blinking can be modified.

Press the DIGIT keys ◀ ▶ a few times to move the blinking digit from the voltage indicator to the current indicator.

- Use the rotary encoder to specify the desired setting.

The hours are set in the voltage indicator, and the minutes are defined in the current indicator. In the figure way below, the output off timer is set for 2 hrs and 20 minutes.

The timer range is from 1 minute to 1000 hours and 59 minutes. The timer can be adjusted in 1 minute increments. Specifying 0 minutes for the timer deactivates the output off timer function.

- Press the green-blinking ENTER/MEM key to enter the setting.

After the setting is entered, the current indicator stops blinking, remains lit for a short while, and then starts blinking again.

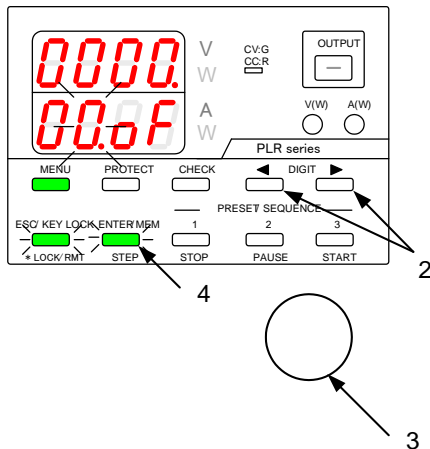

5. Press the green-blinking ESC/KEY LOCK key to exit.

Normal operation of the unit is then available.

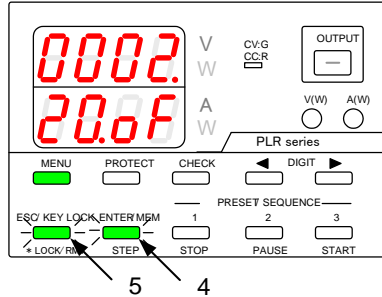

This setting must be specified while the output is off.

Operating the output off timer

Operation procedure

1. Press the OUTPUT key to turn the output on.

The CV/CC LED is lit in green when the output on status is CV, and red when it is CC.

If the output off timer has been set for a certain amount of time, the OUTPUT key is alternately lit in red and amber.

2. Press the MENU key, which is then lit in green. This starts the countdown for the set time specified in "Setting the output off timer" on page 68.

After the set time has passed, the OUTPUT key light goes out, and the output is turned off.

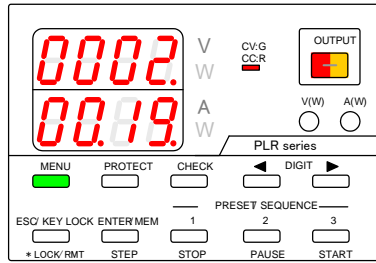
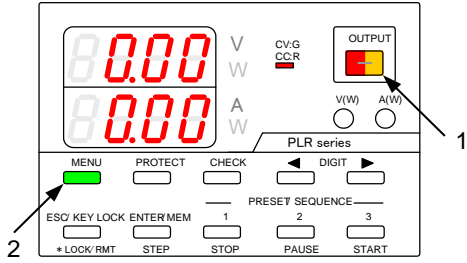

Specifying the automatic cancellation time of the setting menu display

Specifies the amount of idle time is allowed in each setting menu (voltage, current, OVP, UVP and OCP) before the setting display is automatically cancelled.

Operation procedure

1. Turn the output off, then repeatedly press the MENU key until "ESC" is displayed in the voltage indicator.

The MENU key is then lit in green, and the ESC/KEY LOCK key and the ENTER/MEM key starts blinking green.

The function name is displayed in the voltage indicator, and the function setting is displayed (blinking) in the current indicator.

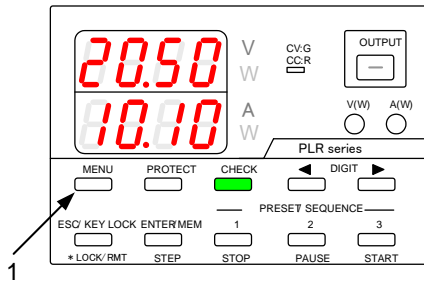

2. Turn the rotary encoder to set the display time, which is displayed in the current indicator.

The display time range is from 0 to 10 minutes, and can be adjusted in 1 minute increments.

(If 0 minutes is set for the display time, the setting display is not disabled automatically.)

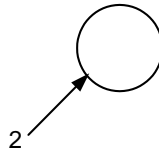
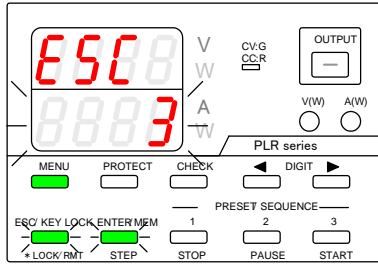

3. Press the green-blinking ENTER/MEM key to enter the setting.

After the setting is entered, the current indicator stops blinking, remains lit for a short while, and then starts blinking again.

Press the green-blinking ESC/KEY LOCK key to exit.

Normal operation of the unit is then available.

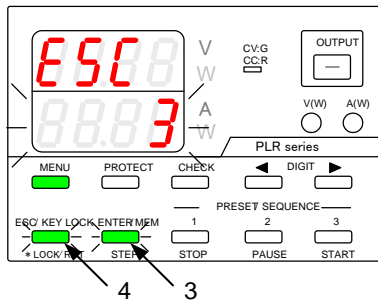

Specifying Settings when the Power is Turned On

Recalling preset values when the power is turned on

The voltage and current values can be set when the power is turned on.

The voltage and current values that can be selected are the set values from when the power was last turned off, and the data that was stored in PRESET keys 1, 2, and 3.

- Operation
1. Turn on the power switch while pressing and holding the MENU key.

Release the MENU key when the panel is lit.

The MENU key is then lit in green, and the ESC/KEY LOCK key and the ENTER/MEM key start blinking green.

The function name is displayed in the voltage indicator, and the function setting is displayed (blinking) in the current indicator.

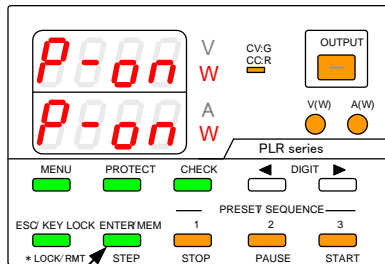

2. Repeatedly press the MENU key until "PrSt" is displayed in the current indicator.
3. Turning the rotary encoder displays the following: Select the values you want to recall.

 LAST ^A _W

The set values from when the power last turned off.

 Pr-1 ^A _W

The values stored in the PRESET 1 key.

 Pr-2 ^A _W

The values stored in the PRESET 2 key.

 Pr-3 ^A _W

The values stored in the PRESET 3 key.

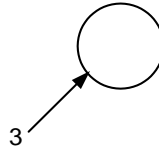
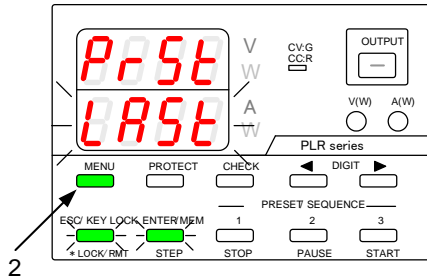

4. Press the green-blinking ENTER/MEM key to enter the setting.

After the setting is entered, the current indicator stops blinking, remains lit for a short while, and then starts blinking again.

- Press the green-blinking ESC/KEY LOCK key to exit. The message shown in the figure below appears. Normal operation of the unit is then available.

Turn the power switch off and then back on to reflect the selected PRESET values.

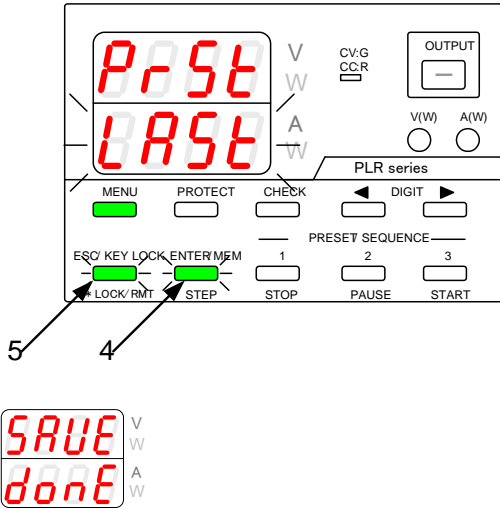

Setting the output when the power is turned on

When the power is turned on, the PLR power supply unit can turn the output on, without needing to push the OUTPUT key.

Operation Procedure

- Turn on the power switch while pressing and holding the MENU key.

Release the MENU KEY when the panel is lit.

The MENU key is then lit in green, and the ESC/KEY LOCK key and the ENTER/MEM key start blinking green.

The function name is displayed in the voltage indicator, and the function setting is displayed (blinking) in the current indicator.

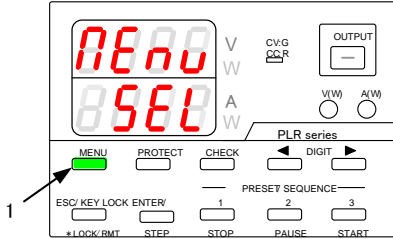

2. Repeatedly press the MENU key until "Pout" is displayed in the voltage indicator.
3. Turning the rotary encoder displays the following in the current indicator. Select the desired setting.



OUTPUT OFF



OUTPUT ON

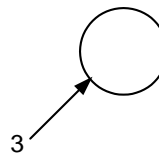
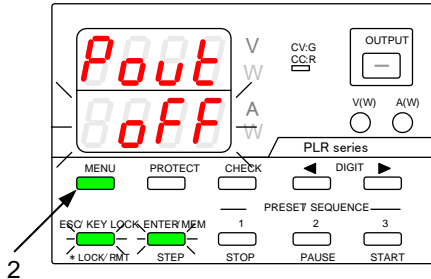

- Press the green-blinking ENTER/MEM key to enter the setting.

After the setting is entered, the current indicator stops blinking, remains lit for a short while, and then starts blinking again.

- Press the green-blinking ESC/KEY LOCK key to exit. The message shown in the figure on the left appears. Normal operation of the unit is then available.

Turn the power switch off and then back on to display the entered voltage and current.

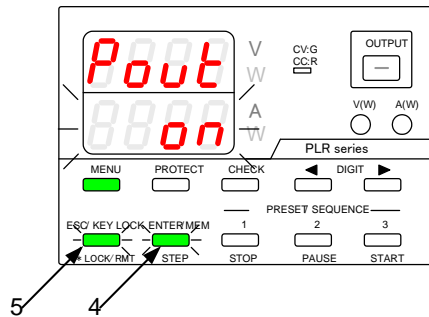

 CAUTION

By specifying the above setting, the unit will start with the output on when the power is turned on. However, this may destroy loads if the wrong voltage or current have been set.

Be sure to confirm the set voltage and current values before turning the power off.

Setting the CC priority mode

Operation procedure

1. Turn on the power switch while pressing and holding the MENU key.

Release the MENU key when the panel is lit.

The MENU key is then lit in green, and the ESC/KEY LOCK key and the ENTER/MEM key start blinking green.

The function name is displayed in the voltage indicator, and the function setting is displayed (blinking) in the current indicator.

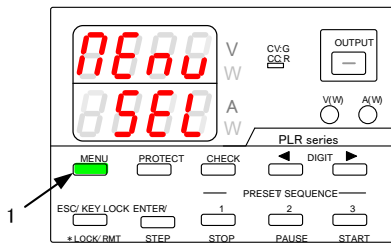

2. Repeatedly press the MENU key until "cc-P" is displayed in the current indicator.
3. Turning the rotary encoder displays the following in the current indicator. Select the desired setting.



CC priority mode off

(When the unit is operated with a load in CV mode while the output is on.)



CC priority mode on
 (When the unit is operated with a load in CC mode while the output is on.)

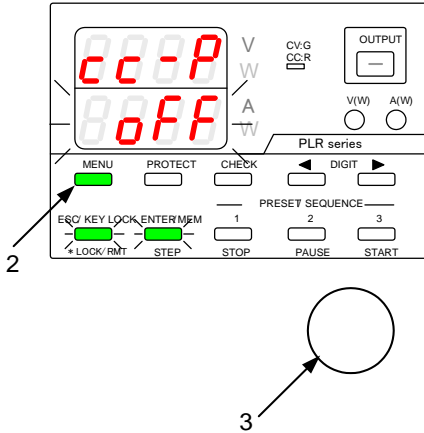

4. Press the green-blinking ENTER/MEM KEY to enter the setting.

After the setting is entered, the current indicator stops blinking, remains lit for a short while, and then starts blinking again.

5. Press the green-blinking ESC/KEY LOCK key to exit. The message shown in the figure on the left appears. Normal operation of the unit is then available.

Turn the power switch off and then back on to display the voltage and current that were entered.

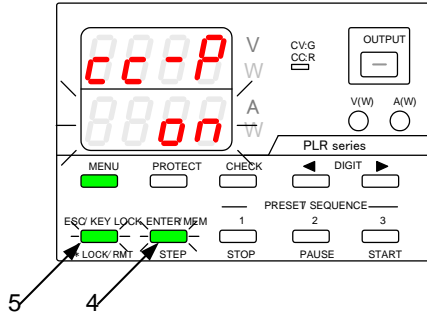

If CC priority mode is off, the CV/CC LED remains unlit while the output is off.

If CC priority mode is on, the CV/CC LED blinks red while the output is off.

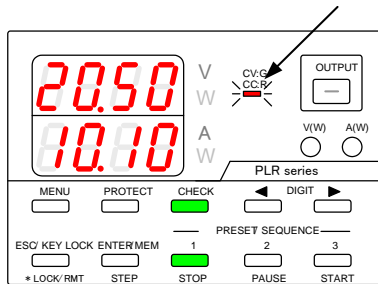

Turning the output on when CC priority mode is selected

The PLR power series is a switching-type DC stabilized power supply unit. A switching-type CV/CC power supply unit consists of circuit in which the power supply transitions from constant-voltage (CV) mode to constant-current (CC) mode, and vice versa. This transition is relatively slower than traditional CV/CC power supply units.

Because of the slow transition from constant-voltage (CV) mode to constant-current (CC) mode, and vice versa, voltage/current overshoot is generated in switching-type CV/CC power supply units when the output is turned on.

If it is determined beforehand that the loads connected to the unit are controlled in CV mode or CC mode, the voltage/current overshoot generated while output is on can be eliminated by using CC priority mode.

The following are the output voltage and current waveforms, according to the state of the CC priority mode, while the output is on.

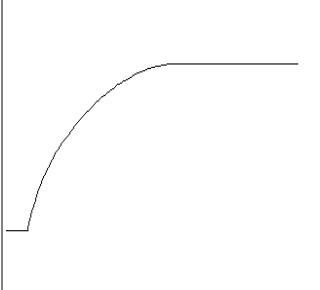
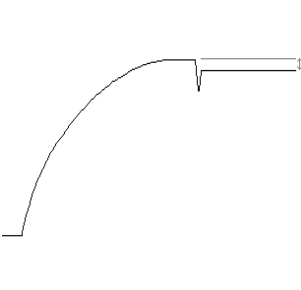
CC mode priority function	Output voltage waveform for when a load causes the unit to operate in CV mode	Output current waveform for when a load causes the unit to operate in CC mode
OFF	 <p data-bbox="303 1262 605 1321">Almost no overshoot in the output voltage.</p>	 <p data-bbox="628 1262 919 1385">An overshoot of approx. 10% of the rated current is generated in the output current.</p>

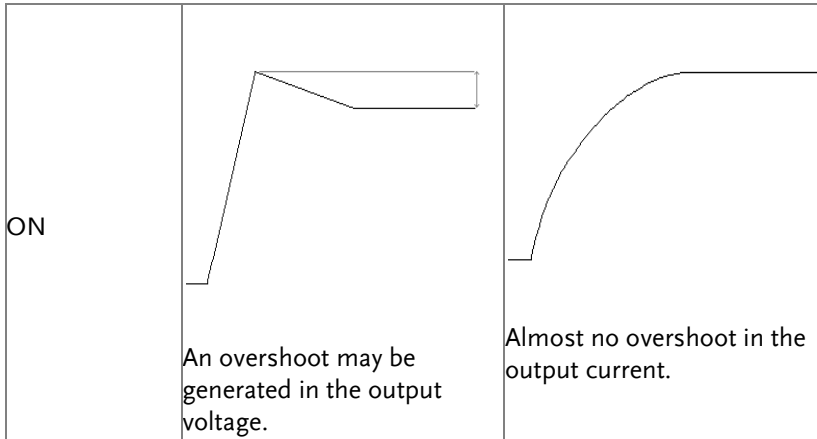

The above voltage and current waveforms assume that the resistance is the load of this unit.

If other loads are used for resistance, the voltage and current waveforms may differ from those shown above.

Setting the display while the output is off

The voltage and current indicators can display either the set values or output values while the output is off.

Operation procedure

1. Turn on the power switch while pressing and holding the MENU key.

Release the MENU key when the panel is lit.

The MENU key is then lit in green, and the ESC/KEY LOCK key and the ENTER/MEM key start blinking green.

The function name is displayed in the voltage indicator, and the function setting is displayed (blinking) in the current indicator.

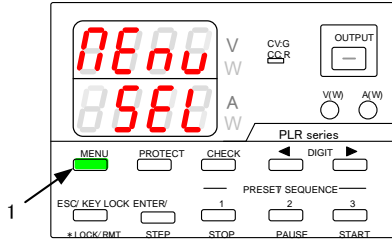

2. Repeatedly press the MENU key until "dSPy" is displayed in the voltage indicator.
3. Turning the rotary encoder displays the following in the current indicator:
Select the desired setting.

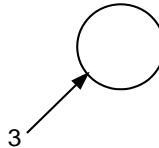
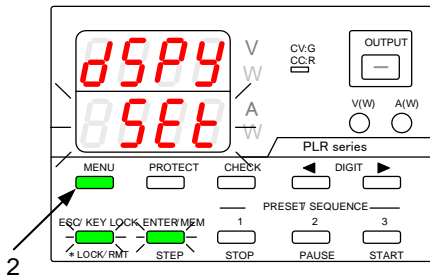

- Press the green-blinking ENTER/MEM KEY to enter the setting.

After the setting is entered, the current indicator stops blinking, remains lit for a short while, and then starts blinking again.

- Press the green-blinking ESC/KEY LOCK key to exit. The message shown in the figure below appears. Normal operation of the unit is then available.

Turn the power switch off and then back on again to display the selected values

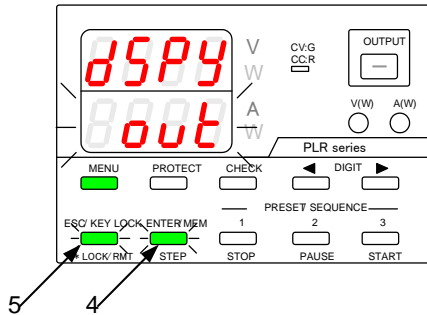

This setting is invalid when the output HI-R function is on. When the output is off, the voltage indicator displays the output voltage, and the current indicator blinks and displays "Hi-r".

Default setting of power relay when the power is turned on

If the remote control card (PLR-GU, PLR-RS or PLR-LU) is installed, the default status (on/off) of the main power relay can be specified when the power is turned on.

1. Turn on the power switch while pressing and holding the MENU key.

Release the MENU key when the panel is lit.

The MENU key is then lit in green, and the ESC/KEY LOCK key and the ENTER/MEM key start blinking green.

The function name is displayed in the voltage indicator, and the function setting is displayed in the current indicator.

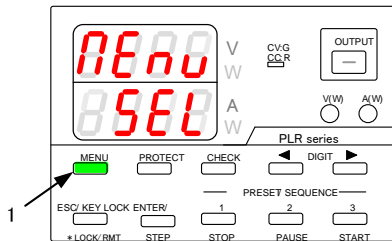

2. Repeatedly press the MENU key until "PonP" is displayed in the voltage indicator.
3. Turning the rotary encoder displays the following in the current indicator:
Select the desired setting.

 ^A_W Displays set values.

 ^A_W Displays output values.

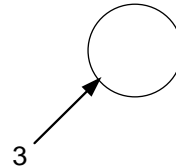
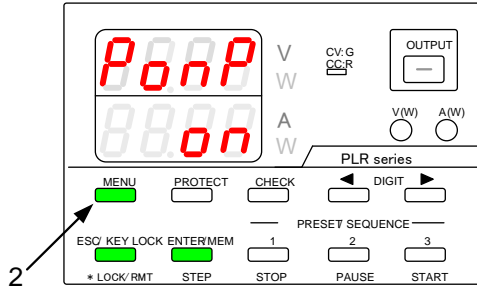

- Press the green-blinking ENTER/MEM key to enter the setting.

After the setting is entered, the current indicator stops blinking, remains lit for a short while, and then starts blinking again.

- Press the green-blinking ESC/KEY LOCK key to exit. The message shown in the figure on the left appears. Normal operation of the unit is then available.

Turn the power switch off and then back on to display the settings that were entered.

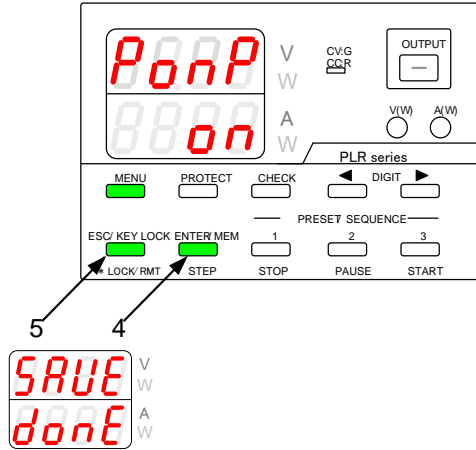

Specifying the baud rate

The PLR-RS card has 2 kinds of mode for RS-232C communication. The factory default PLR-RS was configured as fixed baud: 9600bps; data length: 7bits; stop bit: 1, even parity.

For the configurable baud mode of PLR-RS, this section will describe the procedure. Under this mode the baud is selectable form 1200, 4800, 9600 or 19200. The data length is 8bit. The stop bit is 1 and none of parity.

If the PLR-RS card was configured as configurable baud mode, the baud rate can be specified. There are a total of five available rates that can be specified.

Operation procedure

1. Press and hold the MENU key, and then turn on the power switch. Release MENU key when the panel is lit.

The MENU key is then lit green, and the ESC/KEY LOCK key and the ENTER/MEM key start blinking green.

The function name is displayed in the voltage indicator, and the function setting is displayed

in the current indicator.

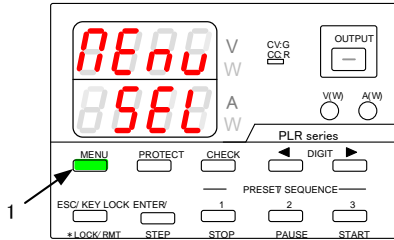

2. Repeatedly press the MENU key until "rAtE" is displayed in the voltage indicator.
3. Turning the rotary encoder displays the following in the current indicator:
Select the desired setting.

"r 1.2"

"r 2.4"

"r 4.8"

"r 9.6"

"r 19.2"

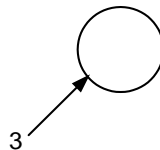
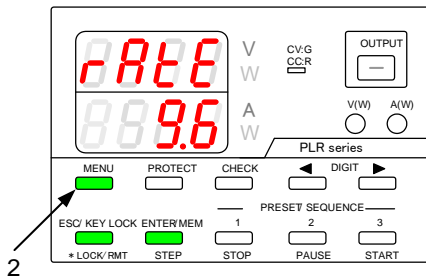

- Press the green-blinking ENTER/MEM key to enter the setting.

After the setting is entered, the current indicator stops blinking, remains lit for a short while, and then starts blinking again.

- Press the green-blinking ESC/KEY LOCK key to exit. The message shown in the figure below appears. Normal operation of the unit is then available.

Turn the power switch off and then back on to display the entered settings.

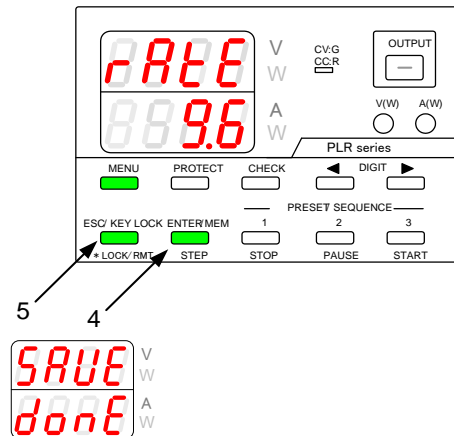

Clearing the Memory

There are 3 different ways to clear the data memory:

- (1) Clearing all the setting data stored in the unit, returning the settings to their factory defaults (factory reset).
- (2) Clearing the setting data for manual operation.
- (3) Clearing the setting data for sequence operation.
- (4) PLR-LU IP address setting

- (1) Clearing all the setting data stored in the unit

Operation procedure

1. Turn on the power switch while pressing and holding the ENTER/MEM key.

Release the ENTER/MEM key when the panel is lit.

The ESC/KEY LOCK key and the ENTER/MEM key then start blinking green.

The type of memory to be cleared is displayed.

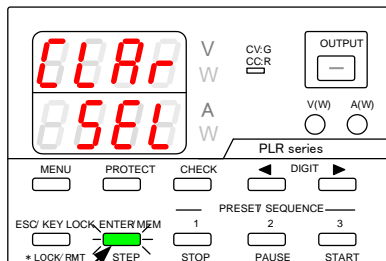

2. Press the ENTER/MEM key.

Pressing the ENTER/MEM key clears the memory.

Pressing the ESC/KEY LOCK key cancels the memory clear.

The message shown in the figure below is displayed. The unit is then restarted automatically.

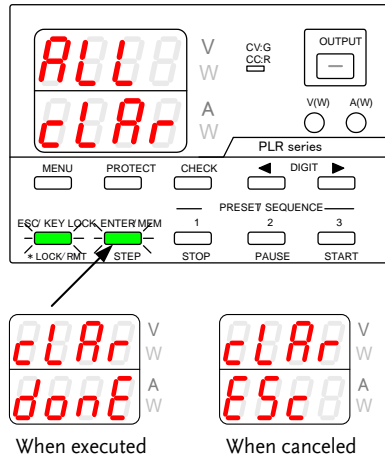

(2) Clearing the setting data for manual operation

Operation procedure

1. Turn on the power switch while pressing and holding the PRESET 1 key.

Release the PRESET 1 key when the panel is lit.

The ESC/KEY LOCK key and the ENTER/MEM key then start blinking green.

The type of memory to be cleared is displayed.

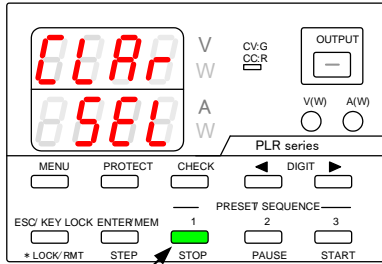

2. Press the ENTER/MEM key.

Pressing the ENTER/MEM key clears the memory.

Pressing the ESC/KEY LOCK key cancels the memory clear.

The message shown in the figure on the left is displayed. The unit is then restarted automatically.

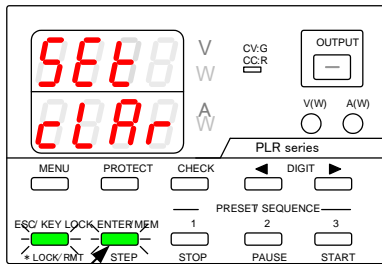

When executed



When canceled

(3) Clear the setting data of the sequence operation

Operation procedure

1. Turn on the power switch while pressing and holding the PRESET 2 key.

Release the PRESET 2 key when the panel is lit.

The ESC/KEY LOCK key and the ENTER/MEM key then start blinking green.

The type of memory to be cleared is displayed.

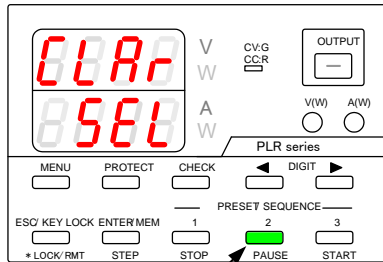

2. Press the ENTER/MEM key.

Pressing the ENTER/MEM key clears the memory.

Pressing the ESC/KEY LOCK key cancels the memory clear.

The message shown in the figure on the left is displayed. The unit is then restarted automatically.

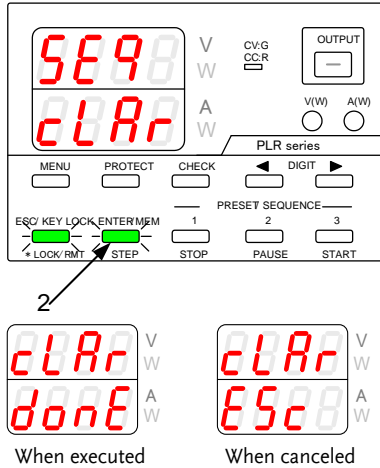

(4) PLR-LU IP address setting

The configured values, such as the IP address, are saved in the PLR-LU. Even if the PLR unit is initialized, the LAN configuration is not reset.

To initialize the LAN for the PLR-LU, perform the following procedure while the PLR-LU is in LAN mode.

During initialization, you can select and configure an automatic IP address or fixed IP address.

For details about configuring an automatic IP address or COM redirector, see the corresponding section in the operation manual. You can download the operation manual from our company's website.

Operation procedure

Turn on the power switch while pressing and holding the PRESET 3 key.

Step 1

The window shown in the figure below appears, and then a request is issued to initialize the XPort of the card. (The window in the figure below is only displayed while in LAN mode.)

If initialization is successful, the number "0" is displayed in the leftmost digit of the current indicator, followed by the number "1" and then "2".

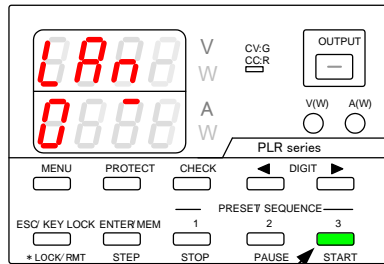

1-1

Step 2

The window shown in the figure on the left is used to select an automatic IP address or fixed IP address.

"1:Auto" (automatic) is displayed in the current indicator, followed by "2:Fix" (fixed). Press the blinking key of the type of address you want to configure.

2-1 Press the PRESET 1 key to configure an automatic IP address.
Go to Step 4.

- 2-2 Press the PRESET 2 key to configure a fixed IP address.
Go to Step 3.

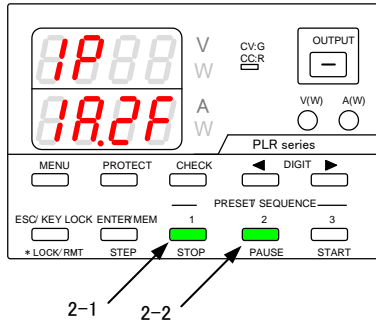

Step 3

The figure on the left shows the window used to configure a fixed IP address.

There are five selection items displayed in the voltage indicator: "IP-0" to "IP-3" (four items), and "Sub" (subnet mask, one item).

Use the corresponding keys to specify the fixed IP address.

- 3-1 Press the ← key to move the cursor to the tens place.
- 3-2 Press the → key to move the cursor to the ones place.
- 3-3 Press the ESC key to return to the value that was saved prior to editing.

- 3-4 Press the ENTER key to save the value and go to the next item.

The IP address in the figure below is as follows:

192.168.1.101 (default value when switching from an automatic IP address to a fixed IP address.

For the subnet mask, specify a number from 0 to 32 when "Sub" is displayed in the voltage indicator.

In the figure on the left, "Sub" indicates "16", for which the set value is "255.255.0.0".

For details about other set values for the subnet mask, see the table in the figure on the left.

- 3-5 Exit the IP settings window.

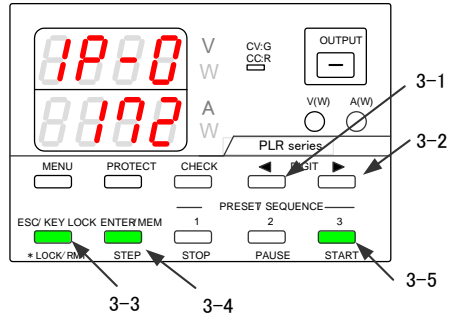

Binary Rotation

Dot decimal notation					Sub setting values
Subnet mask	High order digits	Second digits	Third digits	Low order digits	
255. 0. 0. 0	1111 1111	0000 0000	0000 0000	0000 0000	24
255. 255. 0. 0	1111 1111	1111 1111	0000 0000	0000 0000	16
255. 255. 255. 0	1111 1111	1111 1111	1111 1111	0000 0000	8
255. 255. 255. 240	1111 1111	1111 1111	1111 1111	1111 0000	4

Sub-setting values represent the number of consecutive zeros in the lower bits of IP-3 

Step 4 After you finish configuring the IP address, the left window appears, asking whether you want to perform initialization.

4-1 Press the ESC key to cancel initialization. The power cycling message is displayed.

4-2 Press the MEMORY key to perform initialization.

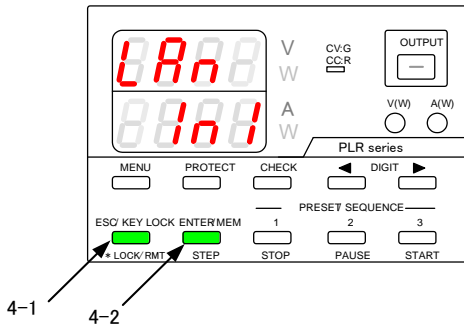

Step 5 The initialization process consists of the following steps: (3) full initialization of Xport, (4) IP address initialization, (5) IO default settings, (6) save initialization data. The steps are displayed in order of execution in the current indicator display: "3", "4", "5", and then "6".

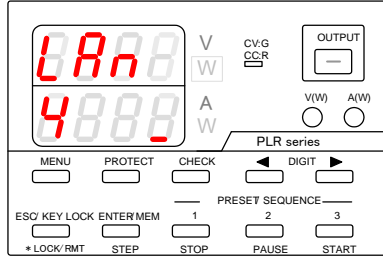

Step 6

When initialization is complete, a message which instructs the user to perform power cycling is displayed, as shown in the figure below.

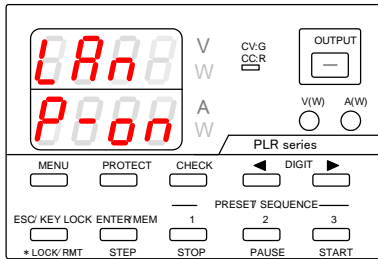

If the initialization request fails, the message "Cont Err" is displayed, as shown on the left.

If the attempt to perform initialization is unsuccessful, the number (No.) of the step at which initialization failed is displayed together with the word "Err". In the figure on the right, initialization failed during step (4), when all the settings were being initialized.

✳Error message displayed during initialization



MASTER-SLAVE

OPERATION

The PLR power supply unit can be used for parallel master-slave operation and serial master-slave operation.

Configuration of Master and Slave Units

When used for parallel master-slave operation and serial master-slave operation, the unit must be configured to operate as a stand-alone unit, serial master unit, serial slave unit, parallel master unit, or parallel slave unit.

Configuring the master and slave units

Steps

1. Turn on the power switch while pressing and holding the MENU key.

Release the MENU key when the panel is lit.

The MENU key is then lit in green, and the ESC/KEY LOCK key and the ENTER/MEM key start blinking green.

The function name is displayed in the voltage indicator, and the function setting is displayed (blinking) in the current indicator.

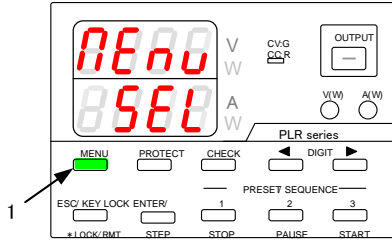

2. Repeatedly press the MENU key until "TIA.SL" is displayed in the voltage indicator.

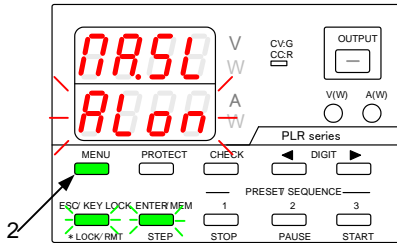

3. Turn the rotary encoder to change the setting displayed in the current indicator.



Stand alone:

Not used for serial or parallel master-slave operation.



Serial master unit:

The unit is used as the master unit for serial master-slave operation.



Serial slave unit:

The unit is used as the slave unit for serial master-slave operation.



Parallel master unit: ※1

The unit is used as the master unit for parallel master-slave



operation.

Parallel slave unit:

The unit is used as the slave unit for parallel master-slave operation.

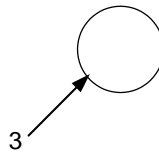
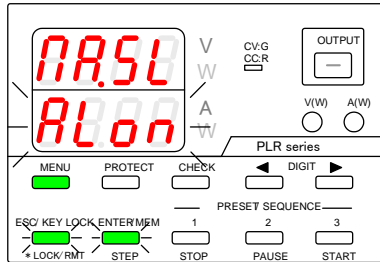

※1 The number of units must be specified when configuring the unit to be the parallel master unit.

- For details about the setting procedure, see the following section “Specifying the number of units” on page 105.

4. Press the green-blinking ENTER/MEM key to enter the setting.

After the setting is entered, the current indicator stops blinking, remains lit for a short while, and then starts blinking again.

- Press the green-blinking ESC/KEY LOCK key to exit. The message shown in the figure on the left appears. Normal operation of the unit is then available.

When the mode is changed, the following message is displayed:

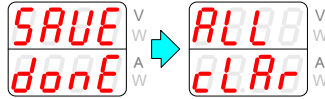

Press the green-blinking ENTER/MEM key to restart the unit.

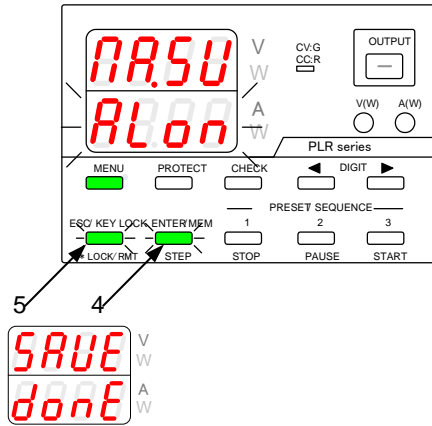

When the unit is configured to be the serial or parallel slave unit, the display shown in the figure below appears.

When this display appears, turn off the power switch.



Specifying the number of units

Specify the number of units when configuring the unit to be the parallel master unit. If the number of units is incorrectly specified, the unit cannot be operated in parallel master-slave operation.

Operation procedure Follow the steps in “Configuration of Master and Slave Units” on page 101 to configure the unit as the parallel master unit.

Steps 1. Press the ENTER/MEM key.

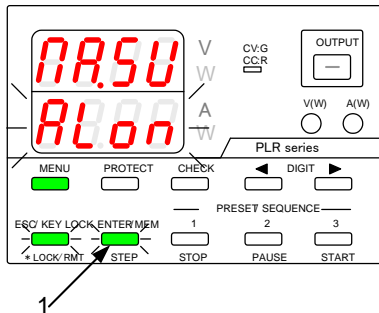

2. Turn the rotary encoder to specify the number of units (including the master unit) for parallel master-slave operation, 2 or 3 units can be selected.
3. Press the green-blinking ENTER/MEM key to enter the setting.
After the setting is entered, the current indicator stops blinking, remains lit for a short while, and then starts blinking again.

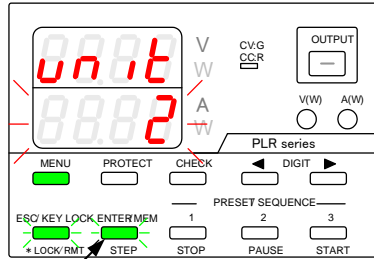

3

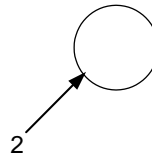

2

4. Press the green-blinking ESC/KEY LOCK key. The message shown in the figure below appears.

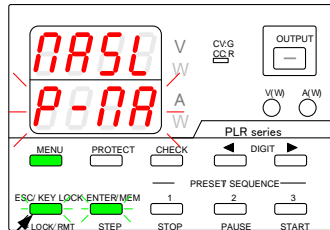

4

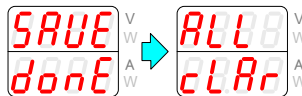

If the same number of units has already been specified for "P-IIA", the following message is displayed. The unit then restarts.



5. Press the green-blinking ENTER/MEM key.

The message shown in the figure below appears, and then the unit restarts. All the settings, except for the communication address and master-slave operation settings, are cleared. Normal operation of the unit is then available.

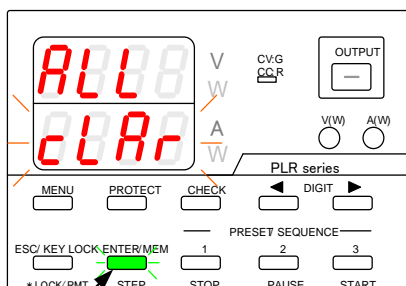

5



If the specified number of units does not match the number that is internally read out by the unit, "SCAn" and "Err.N" are displayed.

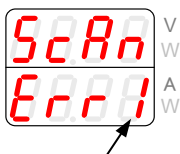

Number of units detected

After configuring the unit to be the parallel master unit, turn off the power switch, and then connect the unit with the parallel slave unit(s).



CAUTION

Precautions for connecting the master unit and slave units:

- DO NOT use PLR-002. This cable is used for serial master-slave operation.

If the PLR-002 cable is used, the control signals from slave units will become unstable and slave units may reach maximum output. This may cause the unit to malfunction or destroy the load.

- Use low-resistance cables to connect to the positive and negative output terminals of the master and slave units.

If there is a large potential difference between the output terminals of the master and slave units, particularly the negative terminals, there may be a difference between the actual current and the current displayed.

For the positive terminal, please ensure that the length of the A, B and C load lines are equal by wiring to the connection point X, as shown in the upper figure. This will lower the displayed current value and reduce the difference between the actual current level and the displayed current level.

Please wire the positive side of the load from connection point X.

Similarly, for the negative terminal, please ensure that the A, B and C load lines are of equal length and wired to connection point Y.

Please wire the negative side of the load from connection point Y.

Serial Master-Slave Operation

Series operation is only possible with two of the same models. Do not use models with differently rated current for serial master-slave operation. Doing so may cause the unit to malfunction.

One unit should be configured as the serial master unit, and another unit as the slave unit.

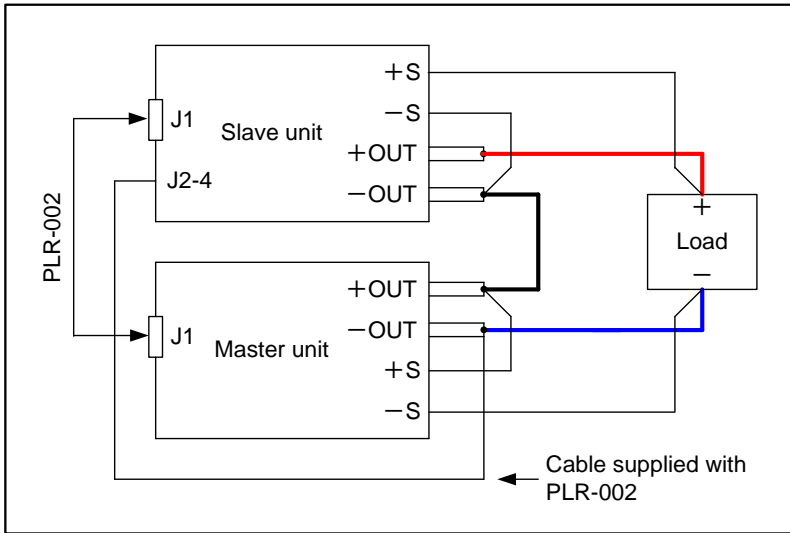

Steps

1. Connect the positive output terminal of the master unit to the negative output terminal of the slave unit, and connect the negative output terminal of the master unit to the negative side of the load. Connect the positive output terminal of the slave unit to the positive side of the load.
2. Use PLR-002 (optional) to connect the J1 connectors of the master and slave units. The J1 connectors are located on the rear panels.

3. Use the cable supplied with PLR-002 to connect pin No.4 on the J2 connector of the slave unit to the negative output terminal of the master unit. The J2 connector is located on the rear panel.
 4. When applying the voltage remote sensing function, use the voltage remote sensing terminals on the master and slave units.
-



CAUTION

Precautions for connecting the master unit and slave units:

- DO NOT use PLR-001. These cables are used for parallel master-slave operation. If PLR-001 is used, the positive and negative outputs of the master slave will short-circuit. This may cause the unit to malfunction.
- If 2PLR power supply units are connected as shown in illustration above, the 2 units will perform serial master-slave operation, even if the master unit is set for stand-alone. In this situation, double the amount set voltage will be output from the units. This may cause an accident or destroy the load. Be sure to configure the master unit as the serial master unit.

S SEQUENCE OPERATION

The PLR power supply unit itself cannot set sequence programs.

Set the sequence programs in the unit via a personal computer, etc. After setting the sequence programs, the programs can be executed without using the digital PLR board.

Sequence programs can be executed in both parallel and serial master-slave operation. If the master-slave setting is modified, the settings for sequence programs stored in the unit will be cleared.

During sequence operation, the voltage/current setting function, preset functions, and the output off timer are not available. In addition, the output cannot be turned on via the OUTPUT key.

Sequence Operation

Turning on the power switch with sequence operation

Following the steps in “Setting the unit to start in sequence operation by turning the power on” on page 112 enables sequence operation after turning on the power switch. When the unit is set for manual operation, turn on the power switch while pressing the PRESET 3 key.

Setting the unit to start in sequence operation by turning the power on

Setting the unit to operate in sequence mode when the power switch is turned on.

Operation
procedure

1. Turn on the power switch while pressing and holding the MENU key.

Release the MENU key when the panel is lit.

The MENU key is then lit in green, and the ESC/KEY LOCK key and the ENTER/MEM key start blinking green.

The function name is displayed in the voltage indicator, and the function setting is displayed (blinking) in the current indicator.

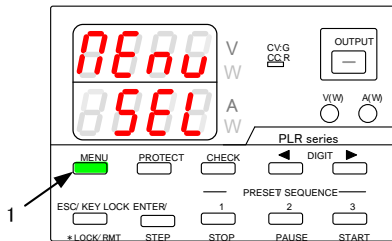

- Repeatedly press the MENU key until "SEq" is displayed in the voltage indicator.

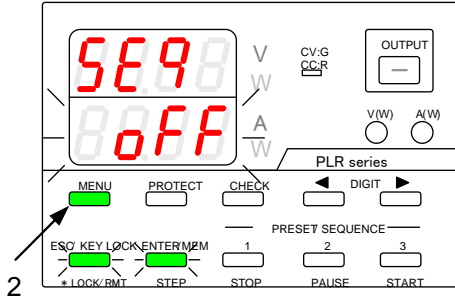

- Turn the rotary encoder to display "on" in the current indicator.

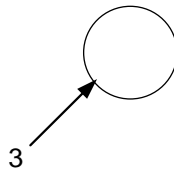
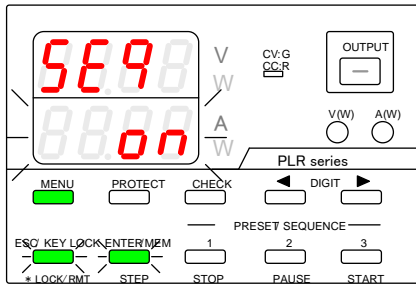
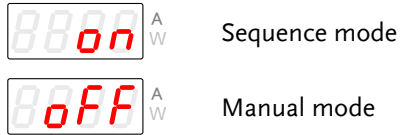

4. Press the green-blinking ENTER/MEM key to enter the setting.

After the setting is entered, the current indicator stops blinking, remains lit for a short while, and then starts blinking again.

5. Press the green-blinking ESC/KEY LOCK key. The message shown in the figure below appears. The display then exits setting mode and switches to sequence mode.

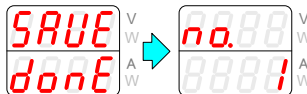
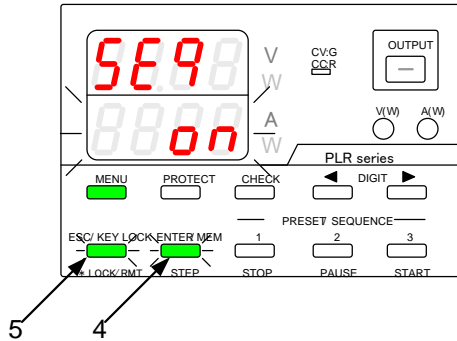

Sequence Programs

A sequence program consists of the settings for each step, and the step execution settings.

Step No. and setting items.

There are 1000 steps. The following items must be specified for each step.

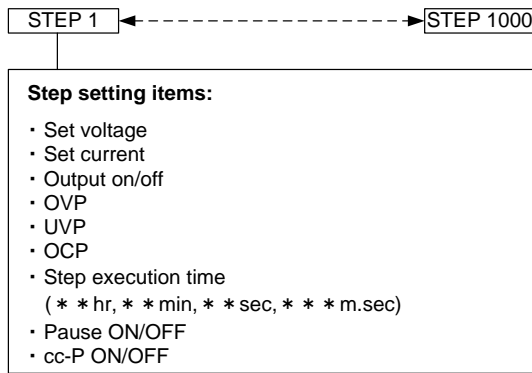

Setting step execution

The step execution range is from "start step" to "end step". The number of execution cycles can be from 1 to 1000, or infinite. There are four execution modes available. Select the desired mode.

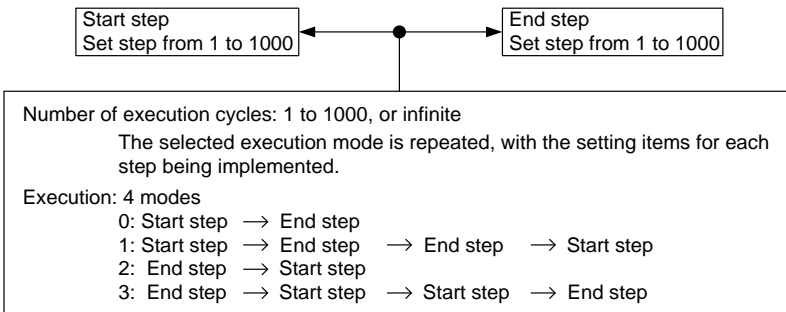

Confirming the Step No. and the Step Being Executed

The step No. and step being executed can be confirmed while the STEP LED is lit in green.

Confirming the step No. while the sequence program is stopped

Operation
Procedure

1. Press the STEP key when the STOP key is lit in amber (while the sequence program is stopped). The STEP key is then lit in green.

The voltage indicator displays "no".
The current indicator displays the step No.

2. Turn the rotary encoder to change the step No. Only the step numbers from start step to end step are displayed.

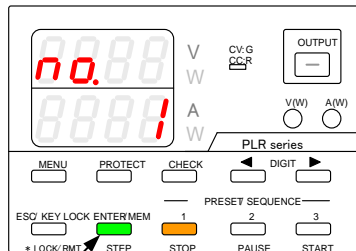

1

2

Confirming the step No. being executed during sequence program execution

Operation procedure

1. Press the STEP key while the PAUSE key or START key is lit in amber (while a sequence program is being executed).

The STEP key is then lit in green. The voltage indicator displays the number of executed program cycles, and the direction in which the program is being executed. The current indicator displays the step No. being executed.

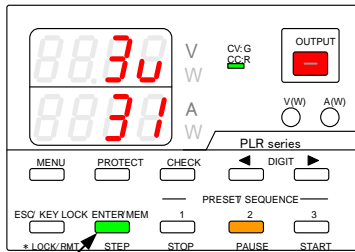

1

The figure on the left indicates that the program is in the 3rd execution cycle, from the start step to the end step, and that step 31 is being executed. The maximum number of execution cycles for a sequence program is "999". The 1000th cycle is displayed as "0".

Number of executed program cycles

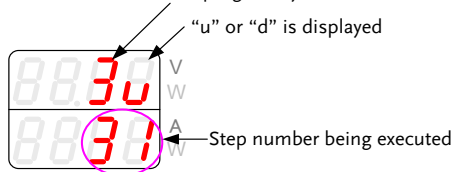



Step execution direction
Start step → End step



Step execution direction
End step → Start step

Confirming the Setting Items for Steps

You can confirm the step setting items.

Operation
Procedure

1. Press the CHECK key, which is then lit in green.

The voltage and current indicators display the step setting items.

2. While the STOP key or PAUSE key is lit in amber (while the sequence program is stopped or paused), turn the rotary encoder clockwise 1 click to switch between the different step setting items. The setting items are displayed in the voltage and current indicators.

See the table below for details about the step setting items.

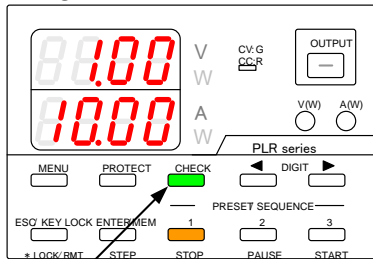

1

2

SEQUENCE OPERATION

Voltage indicator	Current Indicator	Setting item	Remarks
Set voltage	Set current	Voltage/current	
Out	on	OUTPUT	When the output HI-R function is on, the output is set to off.
	oFF		
	Hi-r		
Set OVP	oVP	OVP value	
Set UVP	uVP	UVP value	
Set OCP	oCP	OCP value	
H	n	Execution time (hr, min)	The execution time can be set to the m sec. However, the set time is rounded up to 10m sec. when applying setting items.
Sec.	m sec.	Execution time (sec, m sec)	
PAuS	oFF	PAUSE	If the pause setting is on, the sequence program will pause when the step is finished.
cc-P	on/oFF	CC priority output setting	

While a sequence program is being executed automatically (while the START LED is lit in amber), only the set voltage and current can be confirmed. The other step setting items cannot be confirmed.

Confirming the settings for sequence program execution

The setting items for sequence program execution can be confirmed while the MENU key is lit in green.

Operation Procedure

1. Press the MENU key, which is then lit in green.

The voltage and current indicators display the setting items for sequence program execution.

While the STOP key or PAUSE key is lit in amber (while the sequence program is stopped or paused), turn the rotary encoder clockwise 1 click to switch between the setting items for sequence program execution. The setting items are displayed in the voltage and current indicators.

See the table below for details about the setting items for sequence program execution.

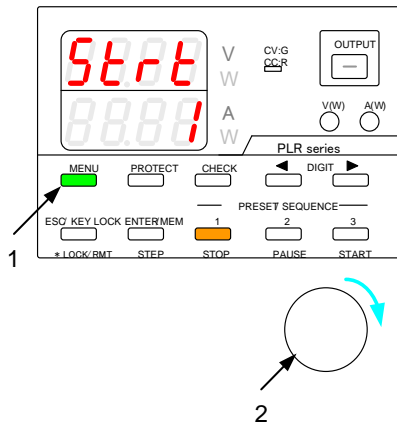

SEQUENCE OPERATION

Voltage indicator	Current Indicator	Setting item for sequence program execution	Remarks
StAt	STEP No.	START STEP	
End	STEP No.	END STEP	
cycL	Number of execution cycles	Number of execution cycles	The number of execution cycles that can be displayed is 1 to 1000. "InF" indicates an infinite number of execution cycles.
IIodE	Execution mode	Execution mode	The execution modes are as follows: 0: START STEP→END STEP 1: START STEP→END STEP→END STEP→START STEP 2: END STEP→START STEP 3: END STEP → START STEP → START STEP→END STEP

When a sequence program is being executed automatically (while the START LED is lit in amber), only the execution time of the step being executed can be confirmed. The other setting items cannot be confirmed.

The voltage indicator displays the hour, and the current indicator displays the minutes and seconds.

Executing Sequence Programs

The START, PAUSE, STOP, and OUTPUT keys are used to execute sequence programs.

Automatic execution of sequence programs

A sequence program can be set to execute automatically from the first step of the program.

Operation Procedure

1. While the STOP key is lit in amber (while the sequence program is stopped), press the START key. The START key is then lit in amber.

When a sequence program is set to execute automatically, the voltage and current indicators display the output values.

When a sequence program is executed automatically, the step to be executed first varies according to the execution mode that has been selected.

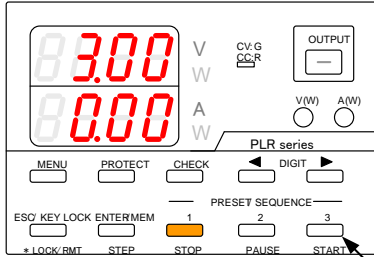

1

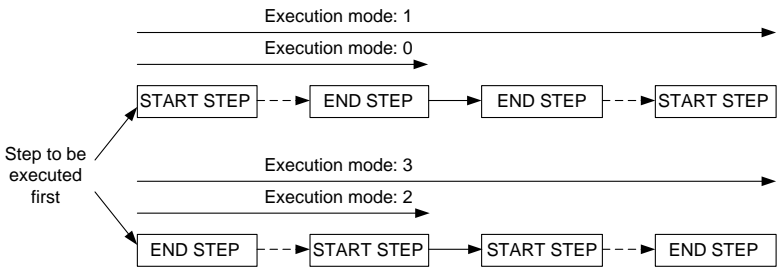
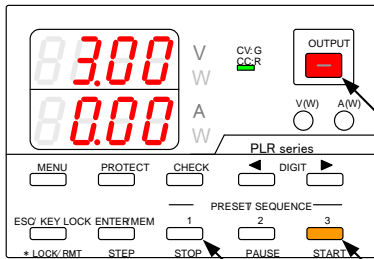

Automatic execution cannot start from a step that is in the middle of the sequence program.

Paused and resumed sequence programs

A sequence program can be paused and resumed.

Operation
procedure

1. While the START key is lit in amber (while the sequence program is being executed automatically), press the PAUSE key.

The PAUSE key then is lit in amber, and the sequence program is paused.

2. While the sequence program is paused, press the START key to resume automatic execution of the program (the START key is then lit in amber again).

The step resumes from the time where it stopped when the PAUSE key was pressed in operation procedure 1.

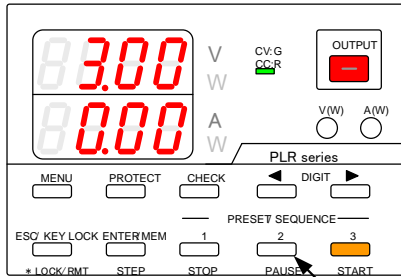

1

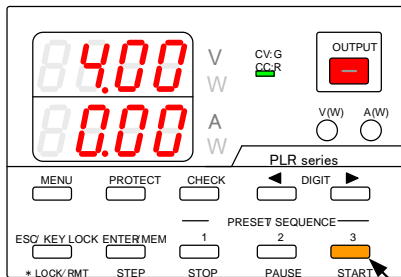

2

While a sequence program is paused, only the step execution time is paused. The other step setting items continue being executed. If the output is set to be on for the step being executed, the unit output will be on.

Manual execution of sequence programs

The PAUSE key and DIGIT keys ◀ ▶ are used to manually execute sequence programs.

Operation Procedure

1. While the STOP key is lit in amber (while the sequence program is stopped), press the PAUSE key or DIGIT key ▶ to pause the sequence program at the first step (if the PAUSE key is pressed, it is then lit in amber).

See next page for details about the steps to be executed.

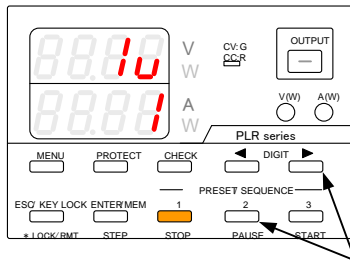

2. While the STOP key is lit in amber (while the sequence program is stopped), press the DIGIT key ◀ to pause the sequence at the last step.

See next page for details about the steps to be executed.

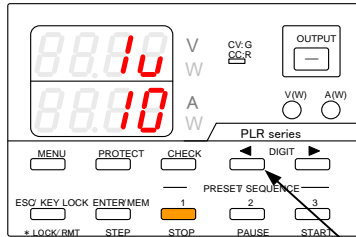

2

3. Press the DIGIT key ▶ to pause the program at the next step.

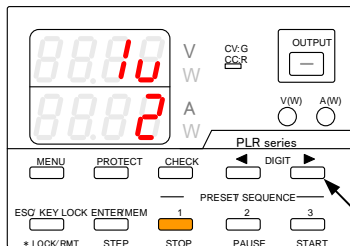

3

4. Press the DIGIT key ◀ to pause the program at the previous step.

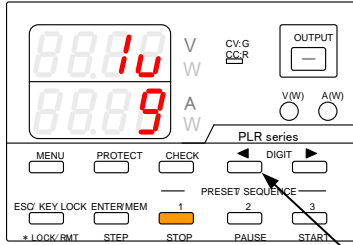

4

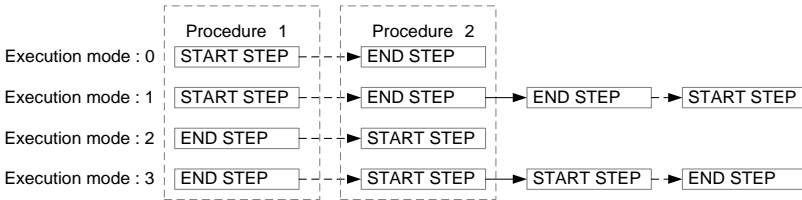

STEP to be executed first

When the DIGIT keys ◀ ▶ are pressed to move to the next step or back to the previous step, if the execution time of the step to be executed next is 0 hr 0 min 0 sec 0 msec, the step will not be executed. The following step will be executed.

Stopping sequence programs

Operation procedure

1. To stop the sequence program, press the STOP key while the START key is lit in amber (while the sequence program is being executed automatically) or while the PAUSE key is blinking amber (while the execution time of the sequence program step is paused).

When the sequence program is stopped, the voltage and current indicator display the step No. that was being executed.

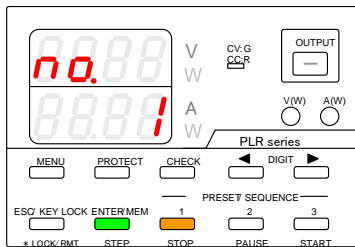
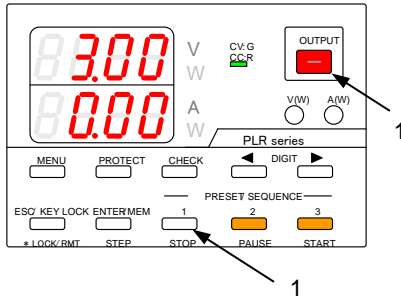

When a sequence program is stopped, the output will be turned off, even if the output is set to be on for the stopped step.

If a sequence program is stopped, it cannot be restarted from the stopped step.

OPERATION BY EXTERNAL ANALOG SIGNAL

The PLR series unit can be operated by using an analog signal from an external device. Replace the interface board according to the type of operation signal used. The following PLR boards can be used with the PLR power supply unit:

- **PLR-ARC (Option):**

Used when the PLR power supply unit is operated by using an analog signal from an external device.

Analog Interface Boards

When you install the PLR-ARC in the unit, you can perform the following operations:

- Turn the output on/off and the main relay on/off through external contacts.
- Change set voltage and current by external voltage or external resistance.
- Output various status signals (alarm, CV, CC, and protection).

Cautions on applying PLR-ARC boards

Be sure to observe the following points when using and installing a PLR-ARC board in the unit.

- When using an external analog signal to operate the unit, the outer contact, voltage, and resistance applied for the operation must be float-mounted. If the outer contact, voltage, and resistance are not float-mounted, the unit's output may short-circuit. This may cause the unit to malfunction.
- The SW 1 (switch 1) of the PLR-ARC board is read out when the power switch of the unit is turned on. Be sure to turn off the power switch before specifying the settings for SW 1. Specifying settings for SW 1 while the power switch is on may cause the unit to malfunction.
- The set voltage/current value represents the externally set voltage/current value, which is superimposed by the internally set voltage/current value. When the power switch is turned on and the status of the PLR-ARC board is read out, if it is detected that the dip switch setting has been modified or that the PLR-ARC board has been replaced, all the set current and voltage values will be 0V and 0A, including the set voltage and current values stored in PRESET 1 to 3. This is done to prevent the set voltage and current from reaching values that may put the load at risk.

When the power switch is turned on and "VA cLAr" appears in the voltage and current indicator displays, as shown in the figure below, press the blinking MEM/ENTER key. The message "cLAr done" appears in the indicator, and it is now possible to turn the power switch on or off.

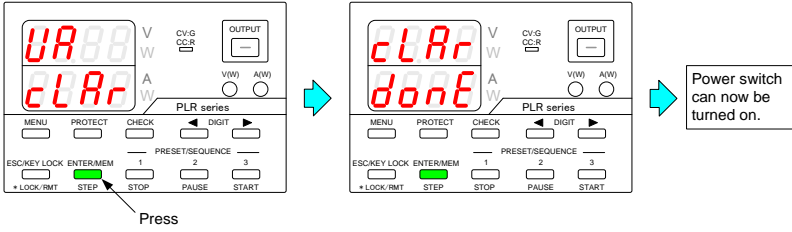

Wiring an analog signal to the PLR-ARC board

See the figure below for details about how to wire an analog signal to the PLR-ARC board, and how to select the logic and different functions.

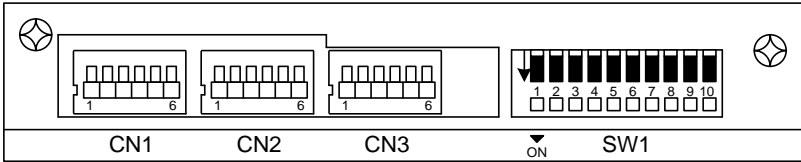

PLR-ARC Board Connector and Dip Switch

While the unit is in operation, connect the applicable outer contact, voltage, and resistance to the negative output of the unit.

Note that the outer contact, voltage, and resistance must be float-mounted.

The photo-coupler, which is used to output alarms and the status of CV mode and CC mode, must be used at a current of 5mA or lower when it is on, and at a voltage of 10V or lower when it is off.

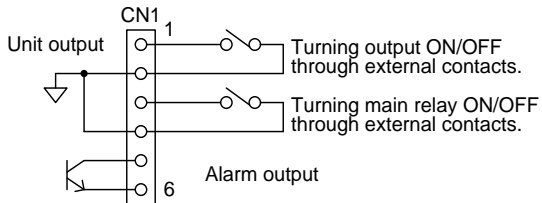

Function	Connection terminal	SW1	Action
Main relay on/off	Pin No.3 to 4 of CN1	Pin No.1 of SW1	<p>OFF</p> <p>Close circuit: Main relay off</p> <p>Open circuit: Main relay on</p>

			ON	Close circuit: Main relay on Open circuit: Main relay off
Output on/off	Pin No.1 to 2 of CN1	Pin No.2 of SW1	OFF	Close circuit: Output off Open circuit: Output on
			ON	Close circuit: Output on Open circuit: Output off
Alarm output	Pin No.5 to 6 of CN1	Pin No.3 of SW1	OFF	Photo-coupler on when status is alarm Photo-coupler off when status is normal
			ON	Photo-coupler off when status is alarm Photo-coupler on when status is normal

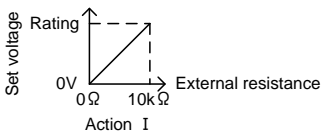
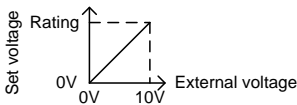
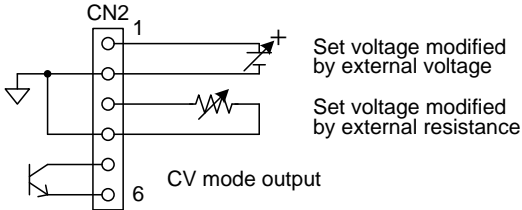

Internally set voltage :0V

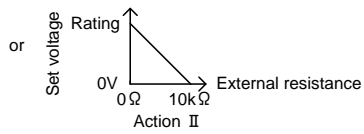

Internally set voltage :rated voltage

Set voltage control via external signal (Valid when pin No.4 of SW1 is on)

RATION BY EXTERNAL ANALOG SIGNAL

Function	Connection terminal	Pin No.5 of SW1	Pin No.6 of SW1	Action
External voltage control	Pin No.1 to 2 of CN2	ON	ON	External voltage 0V→0V Set voltage 0V→Rated voltage
External resistance control: Action I	Pin No.3 to 4 of CN2	ON	OFF	External resistance 0Ω→10kΩ Set voltage 0V→Rated voltage
External resistance control: Action II	Pin No.3 to 4 of CN2	OFF	ON	External resistance 0Ω→10kΩ Set voltage: Rated voltage → 0V
CV mode output	Pin No.5 to 6 of CN2			Photo-coupler is on while in CV mode

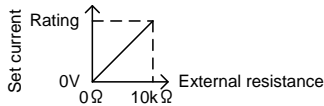
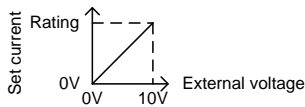
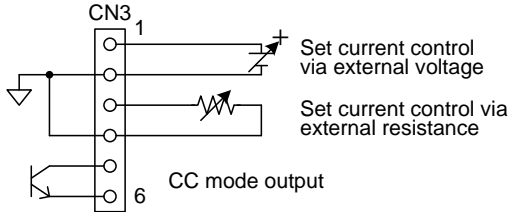

Action I
Internally set current :0A

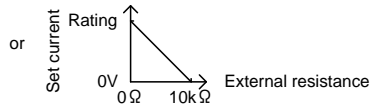

or
Action II
Internally set current : rated current

Set current control by external signal (Valid when pin No.7 of SW 1 is on)

Function	Connection terminal	Pin No.8 of SW1	Pin No.9 of SW1	Action
External voltage control	Pin No.1 to 2 of CN3	ON	ON	External voltage 0V→10V Set current 0A → Rated current
External resistance control: Action I	Pin No.3 to 4 of CN3	ON	OFF	External resistance 0Ω → 10kΩ Set current 0A → Rated current
External resistance control: Action II		OFF	ON	External resistance 0Ω → 10kΩ Set current: Rated current → 0A
CC mode output	Pin No.5 to 6 of CN3			Photo-coupler is on while in CC mode

- See “Adjusting the set voltage” and “Current setting” on page 142 and 148 for details about how to set the internal voltage and current.

If the PLR-ARC board has been installed in the unit, the connectors (CN1, 2, 3), are arranged in the same way as shown in the above figure.

The board features screwless connectors. Press the button of the connector and insert the cable (from which 10 mm of the isolation coat has been stripped) into the hole on the left side of the button.

Use the AWG#24 - #28 cables (UL1007 stranded wire).

Operating the PLR-ARC board

Setting the Voltage

When using the unit with a set voltage that is specified by an external resistance or voltage (hereinafter referred to as the "externally set voltage"), the set voltage value represents the internally set voltage (set by the rotary encoder) which is superimposed by the externally set voltage. While the CHECK key is lit in green, if the V key is unlit or lit in amber, the voltage setting of the internally + externally set voltage is displayed in the voltage indicator. When the V key is lit in green, the voltage setting of the internally set voltage is displayed in the voltage indicator.

Operation procedure

Confirm that the power switch has been turned off.

1. Turn on No. 4 of SW 1, located on the PLR-ARC board. Use an external analog signal to set No. 5 and 6 of SW 1.
 - For details, see "Wiring an analog signal to the PLR-ARC board" on page 135.

To switch over the dip switch, use a needle-nosed tool such as a straight-slot screwdriver.

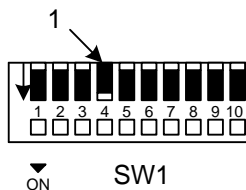

2. Turn on the power switch.

3. Press the CHECK key, which is then lit in green. The voltage indicator displays the set voltage value, which is the internally set voltage superimposed by the externally set voltage. The current indicator displays the set current.
4. Press the V key while pressing and holding one of the DIGIT ◀ ▶ keys.

The V key is then lit in amber.

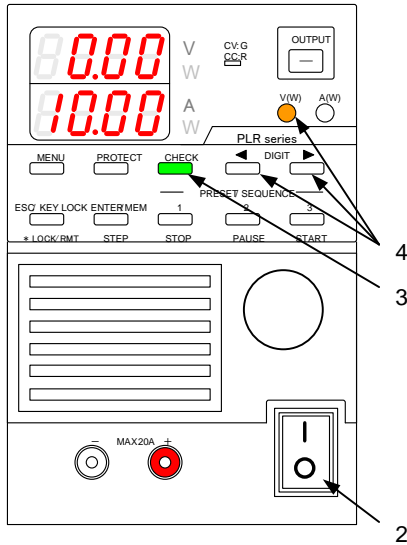

5. Press the V key again. It then begins to blink green.

The internally set voltage is displayed (blinking) in the voltage indicator.

6. Press the DIGIT ◀ ▶ keys to move the blinking digit in the voltage indicator.

- Turn the rotary encoder to modify the internally set voltage.

The variable range of internally set voltage is from -5% to +105% of the rated voltage.

The internally set voltage varies according to the applied external signal.

- For details, “Wiring an analog signal to the PLR-ARC board” on page 135.

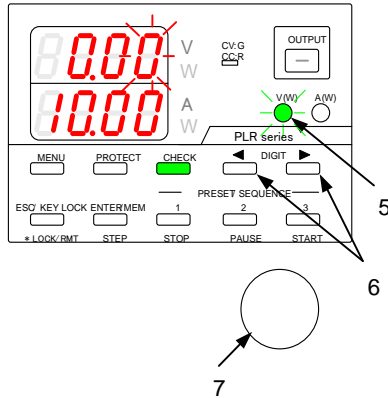

- Press the green-blinking V key. The light then goes out.

Input the external analog signal into the connector on the PLR-ARC board. The voltage indicator displays the set value that corresponds to the external analog signal. The display range of the set voltage is from -10% to +110% of the rated voltage.

The PLR-ARC board connector varies according to the type of external analog signal.

- For details, “Wiring an analog signal to the PLR-ARC board” on page 135.

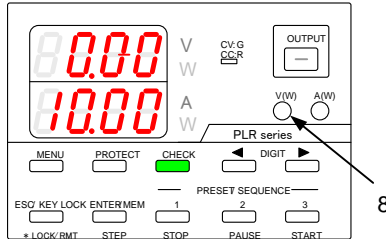

The voltage that can be set by performing this operation may exceed the maximum rated voltage of the unit, depending on how it is used.

When the voltage is set lower than 0V or higher than 102.5% of the rated voltage, all the digits on the voltage indicator will blink, and the output will be turned from on to off.

Adjusting the set voltage

Modify the internally set voltage to adjust the set voltage specified by the externally set voltage.

- See "Setting the Voltage" on page 139 for details about how to input the external analog signal into the connector of the PLR-ARC board.
1. Press the CHECK key, which is then lit in green. The voltage indicator displays the set value that corresponds to the external analog signal.

- Press the V key while pressing and holding one of the DIGIT ◀ ▶ keys. The V key then is lit in amber.

A digit starts blinking in the voltage indicator. The current indicator displays the value of the internally set voltage.

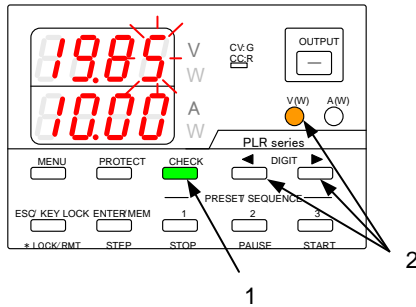

- Press the DIGIT ◀ ▶ keys to move the blinking digit in the voltage indicator.
- Turn the rotary encoder to modify the internally set voltage.

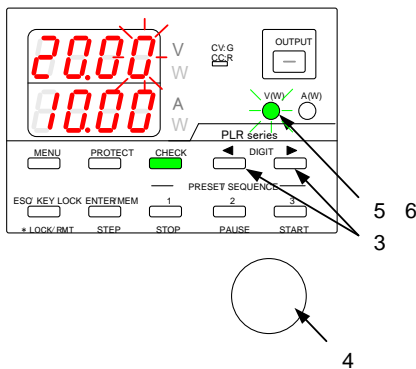

- Press the V key. The key then starts to blink green.

- Press the green-blinking V key. The light then goes out. The blinking digit in the voltage indicator stops blinking and then remains lit.

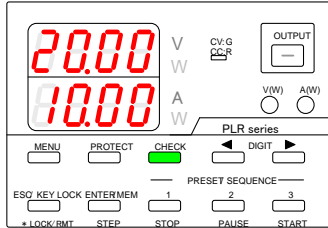

Current setting

When using the unit with a set current that is specified by an external resistance or voltage (hereinafter referred to as the "externally set current"), the set current value represents the internally set current (set by the rotary encoder) which is superimposed by the externally set current. While the CHECK key is lit in green, if the A key is unlit or lit in amber, the current setting of the internally + externally set current is displayed in the current indicator. When the A key is lit in green, the current setting of the internally set current is displayed in the current indicator.

Operation Procedure

Confirm that the power switch has been turned off.

- Turn on No. 7 of SW 1, which is located on the PLR-ARC board.

Use an external analog signal to set No. 8 and 9 of SW 1.

- For details, see "Wiring an analog signal to the PLR-ARC board" on page 135.

To switch over the dip switch, use a needle-nosed tool such as a straight-slot screwdriver.

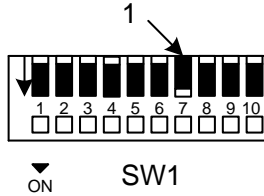

2. Turn on the power switch.
3. Press the CHECK key, which is then lit in green. The voltage indicator displays the set voltage. The current indicator displays the set current value, which is the internally set current superimposed by the externally set current.
4. Press the A key while pressing and holding one of the DIGIT ◀ ▶ keys. The A key is then lit in amber.

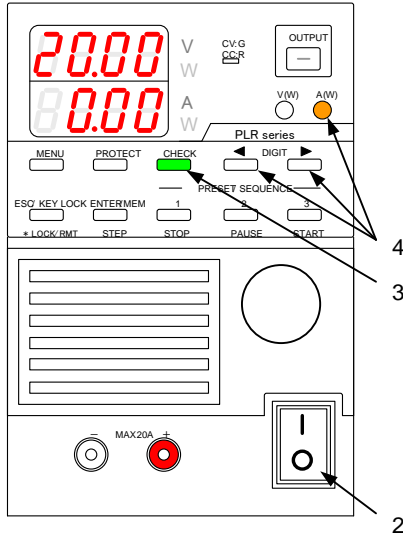

5. Press the A key again. The key then starts to blink green.

The internally set current is displayed (blinking) in the current indicator.

6. Press the DIGIT ◀ ▶ keys to move the blinking digit in the current indicator.
7. Turn the rotary encoder to modify the internally set current.

The variable range of internally set current is from -5% to +105% of the rated current.

The internally set current varies according to the externally applied signal.

- For details, see “Wiring an analog signal to the PLR-ARC board” on page 135.

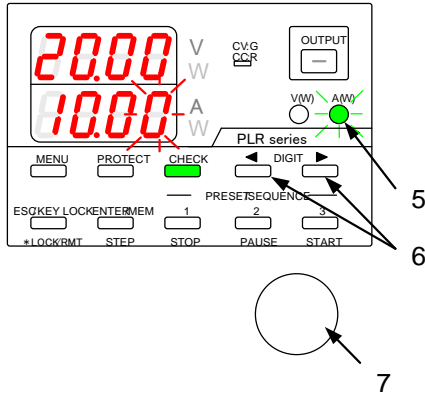

8. Press the green-blinking A key. The light then goes out.

Input the external analog signal to the connector on the PLR-ARC board. The current indicator displays the set value that corresponds to the external analog signal. The display range of the set current is from -10% to +110% of the rated current.

The connector of the PLR-ARC board varies according to the type of external analog signal.

- For details, see “Wiring an analog signal to the PLR-ARC board” on page 135.

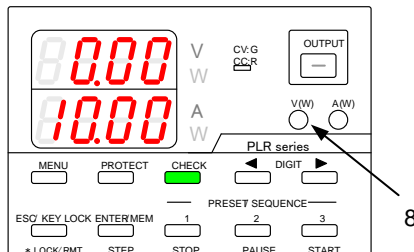

The current that can be set by performing this operation may exceed the maximum rated current of the unit, depending on how it is used.

When the current is set lower than 0A or higher than 102.5% of the rated current, all the digits on the voltage indicator will blink, and the output will be turned from on to off.

Adjusting the set current

Modify the internally set voltage to adjust the set current specified by externally set voltage.

Operation Procedure

For details about inputting the external analog signal to connector of the PLR-ARC board, see "Current setting" on page 144.

1. Press the CHECK key, which is then lit in green. The current indicator displays the set current value that corresponds to the external analog signal.
2. Press the A key while pressing and holding one of the DIGIT ◀ ▶ keys.

The A key then becomes lit in amber.

The current indicator displays the internally set current. A digit starts blinking in the current indicator.

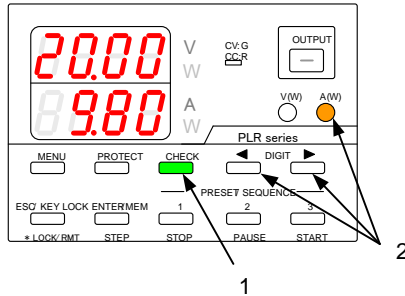

3. Press the DIGIT ◀ ▶ keys to move the blinking digit in the current indicator.
4. Turn the rotary encoder to modify the internally set current.
5. Press the A key.

The key then starts to blink green.

6. Press the green-blinking A key.

The light then goes out. The blinking digit in the current indicator stops blinking and then remains lit.

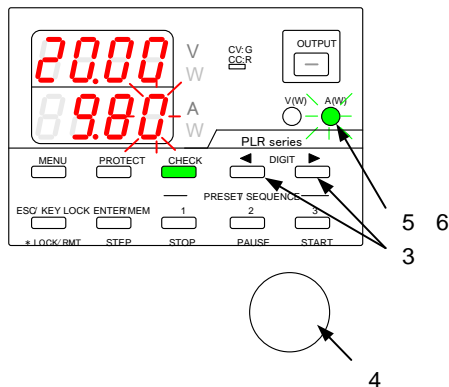

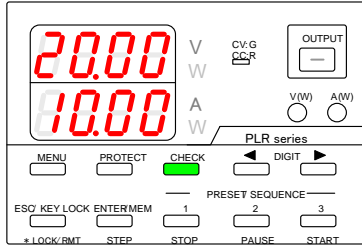

Turning the output on/off through external contacts

If the PLR-ARC board is installed in the PLR power supply unit, you can turn the output on/off operation through external contacts.

To turn the output of the unit on, both the OUTPUT key and external contacts must be used.

Operation
Procedure

Turn off the unit power switch, and turn the output off through the external contacts.

For details about turning the output on/off through external contacts, see “Wiring an analog signal to the PLR-ARC board” on page 135.

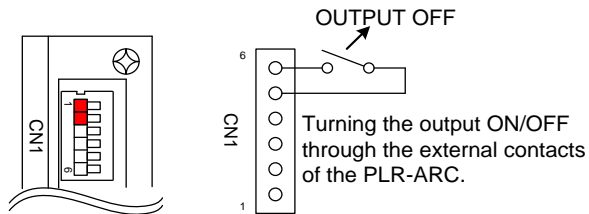

1. Turn on the power switch while pressing and holding the MENU key.

Release the MENU key when the panel is lit.

The MENU key is then lit in green, and the ESC/KEY LOCK key and ENTER/MEM key start blinking green.

The function name is displayed in the voltage indicator, and the function setting is displayed (blinking) in the current indicator.

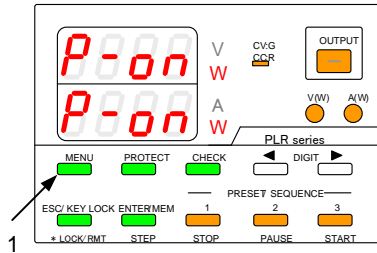

2. The output setting for when the power is turned on must be set to "on" by using the MENU key and rotary encoder.

("Pout" is displayed in the voltage indicator, and "on" in the current indicator)

For details, see "Setting the output when the power is turned on" on page 76.

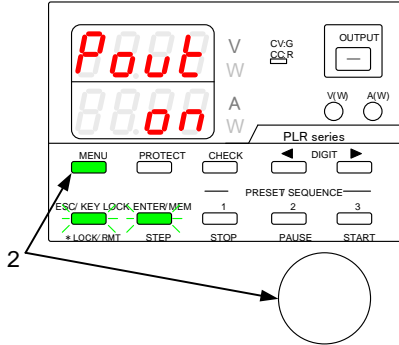

- Use the external contacts of the PLR-ARC board to turn the output on.

The OUTPUT key is then lit in green, and the output of the unit is turned on.

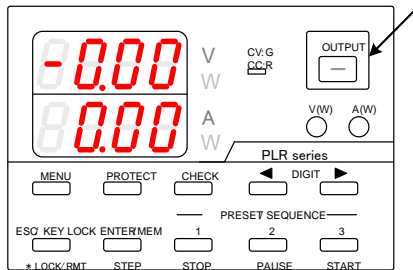
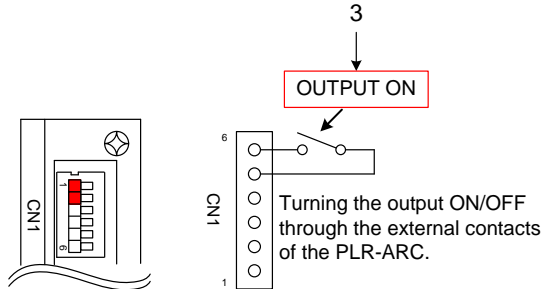

4. Use the external contacts of the PLR-ARC board to turn the output off.

The OUTPUT key light goes out, and the output of the unit is turned off.

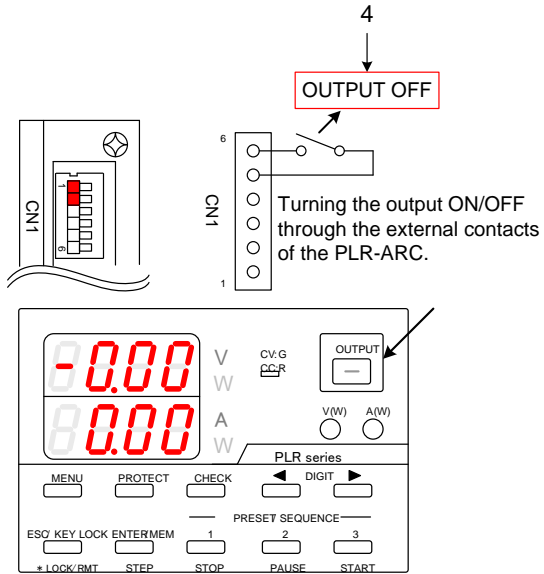

In the PLR power supply unit, when the output of the unit has been turned on through the external contacts of the PLR-ARC board, the OUTPUT key on the front panel can be used to turn the output on or off during operation.

Thus, in case of an emergency where the power supply from the unit to the loads must be stopped, the power supply from the unit can be stopped without needing to turn off the power switch.

Checking the status when the output is off

If the PLR-ARC board has been installed in the unit and the output of the unit is off, the following items can be checked:

Operation Procedure

1. Press the MENU key while the output is off.
The following messages are displayed:
Voltage indicator: "FP.oF"
Current indicator: "Et.xx"

The MENU key then is lit in green, and the ESC/KEY LOCK key starts blinking green.

Voltage indicator Voltage indicator



Output on



Output off

Current indicator Status of output on/off setting that uses the external contacts of the PLR-ARC board



Output on



Output off

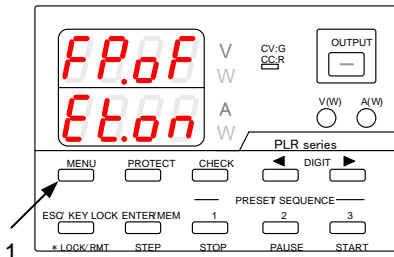

2. Press the green-blinking ESC/KEY LOCK key to exit.

Normal operation of the unit is then available

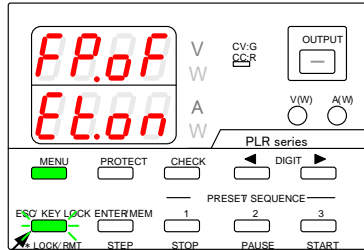

2

If the PLR-ARC board has not been installed in the unit, this function is not available.

Main relay ON/OFF operation

When the power of multiple PLR units is turned on at one time, a large rush of current flows into the primary side. This may generate current distortion in the AC line, affecting the devices connected to the AC line to which the PLR units are connected.

Specify "off" as the Main relay setting for all the PLR units, and then turn on the power switch. Next specify "on" as the Main relay setting for each unit, one unit at a time. This disperses the rush current on the primary side and diminishes current distortion in the AC line.

If the PLR-ARC board has been installed and the Main relay is off, "P-oF" is displayed in both the voltage indicator and current indicator when the power switch is turned on. At this time, only the internal power supply source is running.

If the Main relay is set to "on" when external contacts of the PLR-ARC board are closed or short-circuited, "P-on" is displayed in both the voltage indicator and current indicator. The power can then be turned on or off.

For details about how to turn Main relays on or off, see "Wiring an analog signal to the PLR-ARC board" on page 135.

INTERFACE OPTION

Accessories

The supplied accessories differ according to the optional interface board (PLR Series) that is used.

PLR-GU unit accessories



Short pin 3 pcs



Instruction Manual 1 copy

PLR-LU unit accessories



Short pin 3pcs



Instruction Manual 1 copy

REMOTE CONTROL

Outline

The PLR series unit can be remotely controlled by a personal computer (hereinafter "PC") or sequencer via PLR-RS (standard), PLR-GU(optional) or PLR-LU(optional).

Because the digital communication interface has a local bus, a single PC or sequencer can control multiple PLR series units.

The optional digital communication interface boards (referred as "digital PLR board" hereinafter) for the PLR series are as follows:

- PLR-GU: Used with GP-IB and USB digital communication interfaces. Can be connected to a PC for remote control.
- PLR-LU: Used with LAN and USB digital communication interfaces. Can be connected to a PC for remote control.
- PLR-RS: Used with communication interfaces that are compatible with RS-232C. Can be connected to a PC or sequencer for remote control. This interface is standard.

PLR-GU

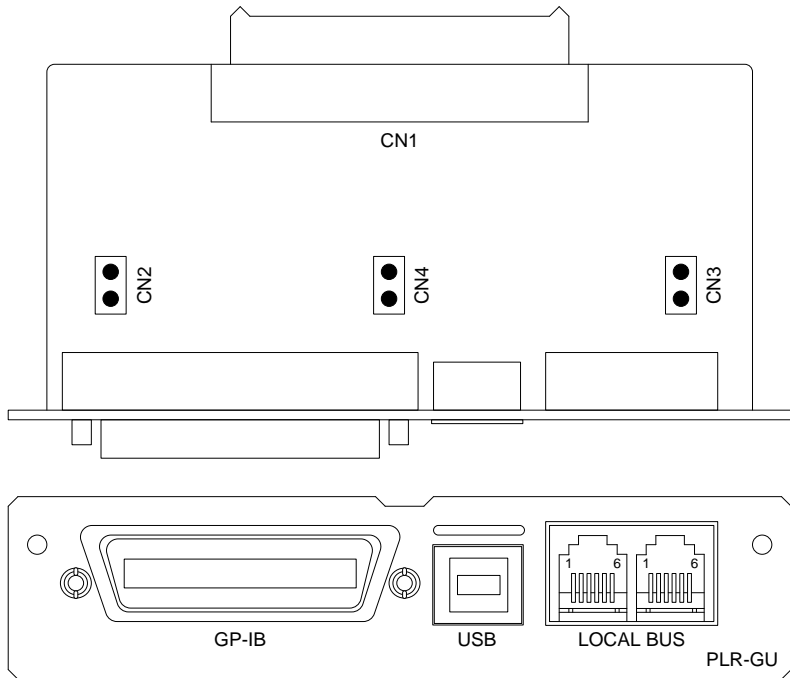

Connector name	Function
GP-IB	Connects to the GP-IB controller of PC.
USB	Connects to the USB port of a PC or USB hub.
LOCAL BUS	Connects to the local bus. A dedicated modular cable is required to connect to the local bus.
CN1	Connects to the power unit. For details about how to connect to the power unit, see the PLR-GU instruction manual.

CN2 Short-circuits the frame GND and signal GND of GP-IB and USB.

CN 2 is used to eliminate ground loops in noisy environments.

CN3 Connects to the terminator of the local bus and the internal bus when the circuit is closed. In the local bus, a terminator is required for the power supply units at each end of the signal line or for stand alone.

CN4 Switches operation between the GP-IB and USB.
The GP-IB operates when the circuit is closed, and the USB operates when the circuit is open.

PLR-LU

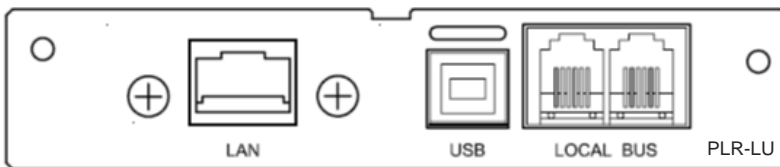
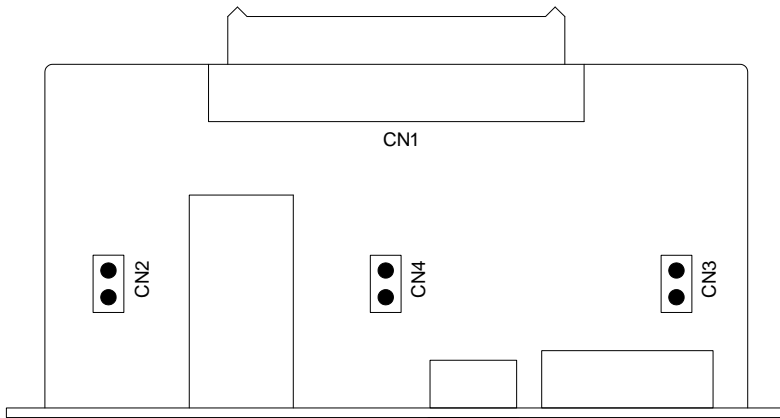

Connector name	Function
LAN	Connects to a controller, such as the controller of a LAN switching hub.
USB	Connects to the USB port of a PC or USB hub.
LOCAL BUS	Connects to the local bus. A dedicated modular cable is required to connect to the local bus.
CN1	Connects to the power unit. For details about how to connect to the power unit, see the PLR-LU instruction manual.
CN2	Short-circuits the frame GND and signal GND of the LAN and USB. CN 2 is used to eliminate ground loops in noisy environments.
CN3	Connects to the terminator of the local bus and the internal bus when the circuit is closed. In the local bus, a terminator is required for the power supply units at each end of the signal line or for stand alone.
CN4	Switches between LAN and USB operation. The LAN operates when the circuit is closed, while the USB operates when the circuit is open.

PLR-RS

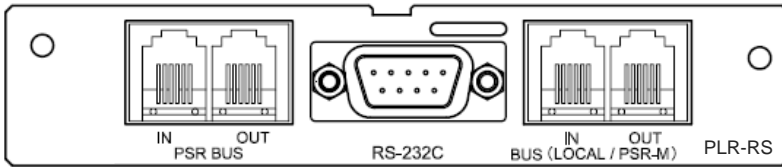
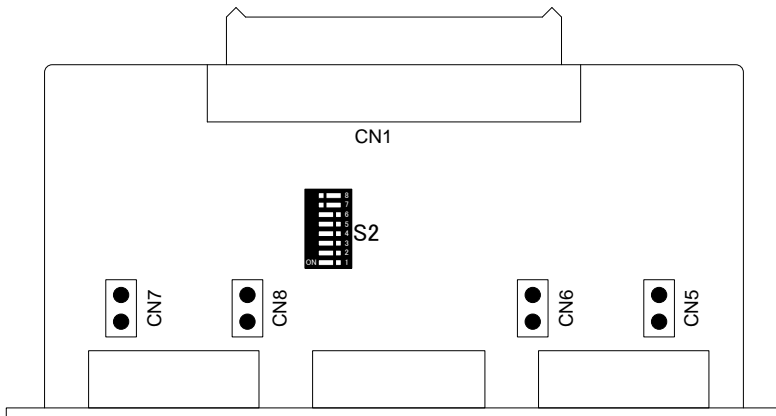

Connector name	Function
PSR BUS	Not used.
RS-232C	Used together with a crossover cable to connect to the RS-232C of a PC.
LOCAL	Used together with a dedicated modular cable to connect to the local bus.
CN1	Connects to the power unit. For details about how to connect to the power unit, see the PLR-RS instruction manual.

CN5	Connects to the terminator of the local bus and the internal bus when the circuit is closed. In the local bus, a terminator is required for the power supply units at each end of the signal line or for stand alone.
CN6	Switches over to local bus mode. CN6 provides compatibility with the local bus of PLR when the circuit is open.
CN7	Switches over to RS-232C mode. CN7 provides compatibility with the local bus of PLR when the circuit is closed.
CN8	Short-circuits the frame GND and signal GND of RS-232C.
S2	For baud rate 9600 fixed mode (Factory default): Set the pins from 1 to 6 of DIP switch S2 on the PLR-RU card to position marked "ON", while the rest pins (pin 7 and 8) to the other side "OFF". For baud rate configurable mode: Set the pin 7 and pin 8 of DIP switch S2 on the PLR-RU card to position marked "ON", while the rest pins (pin 1 to 6) to the other side "OFF".

Cable and connector settings

The circuits for all the connectors are open by default. Adjust the connector settings according to the type of control used.

- (1) When GPIB is used: A commercially available GP-IB cable can be used for the GP-IB connection of PLR-GU.

When GP-IB is used, the settings of the PLR-GU connectors are as follows:

Connector	Circuit
CN2	Closed

CN3	Closed
CN4	Closed

- (2) When USB is used: Use a commercially available USB full speed cable for the USB connection.

When a USB is used, the settings of the PLR-LU connectors are as follows:

Connector	Circuit
CN2	Closed
CN3	Closed
CN4	Open

- (3) When a LAN is used: Use a commercially available LAN cable (category 5E or higher) to connect PLR-LU to a LAN.

When a LAN is used, the settings of the PLR-LU connectors are as follows:

Connector	Circuit
CN2	Closed
CN3	Closed
CN4	Closed

- (4) When a RS-232C is used: Use commercially available crossover cables or interlink cables for the RS-232C connection.

The wiring of RS-232C cable is as follows:

Three lines are used: the sending, receiving, and grounding lines.

The hardware flow-control line is not used.

The wiring of the other terminals is disregarded.

PC / Sequencer				PLR-RS		
D-Sub9 pin Female	2	RxD	↔	TxD	3	D-Sub9 pin Female
	3	TxD	↔	RxD	2	
	5	GND	↔	GND	5	

When a RS-232C is used, the settings of the PLR-RS connectors are as follows:

Connector	Circuit
CN5	Closed
CN6	Open
CN7	Closed
CN8	Open

- (5) When local bus is used: Use a straight 6-pin modular cable for the local bus connection.

This cable is a twisted pair cable with D+ and D-signals.

Connector	Signal	Cable part No.	Cable length
PIN1	Case GND	GRJ-1102	1.5m
PIN3	D+		
PIN4	Signal GND		
PIN5	D-		

Address settings

If the PLR-GU, PLR-LU, or PLR-RS is mounted on the PLR power supply unit, the address setting will appear on the menu when the unit is turned on and started by pressing and holding the MENU key.

There are two types of addresses for PLR units: a system address (SYAD) and a PC address (PCAD).

- The system address is used to identify the PLR power supply unit when the unit is connected via a local bus. This address is specified by the PLR-GU, PLR-LU or PLR-RS. The system address must be specified as Address 1 of the unit which is connected to the controller (PC or sequencer).
Communication with the controller is only possible if the system address has been specified as Address 1.
If you assign multiple system addresses to a local bus, make sure to assign a different value for each address. If you assign the same value multiple times, communication errors might occur.
- The PC address is used to identify the PLR unit when the unit is directly connected to the PC.
- The respective use of the PC address varies according to the connection method.

Communication method	Use of PC address
GP-IB	GP-IB address.
USB	Device address for the USB device driver.
LAN	Used to identify the unit by commands when the IP address is automatically allocated.
RS-232C	Not available.

* When USB is used, the PC address acts as a device address. In this case, do not connect PLR power supply units that have the same address.

Operation
Procedure

1. Turn on the power switch while pressing and holding the MENU key.

Release the MENU key when the panel is lit.

"SYAd" (system address) is then displayed in the voltage indicator.

2. Turn the rotary encoder to change the value.

If the PLR unit is connected to a PC, specify "1" as the system address. If the unit is connected to local bus, a value from "2" to "31" can be specified as the address.

3. After specifying the value, press the ENTER key.

If the system address is set to "1" and pressing the ENTER key, "PCAd" (PC address) is then displayed in the voltage indicator.

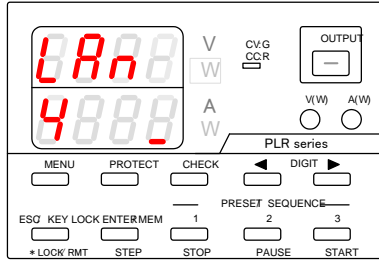
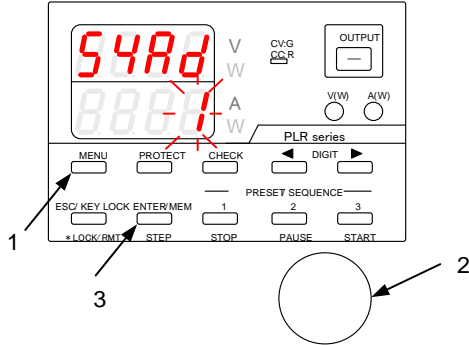

4. Turn the rotary encoder to change the value. The value range is from "0" to "31".
5. Press the ENTER key to specify "PCAd".

When you are finished, press the ESC key to exit. After the address has been set, the unit reboots.

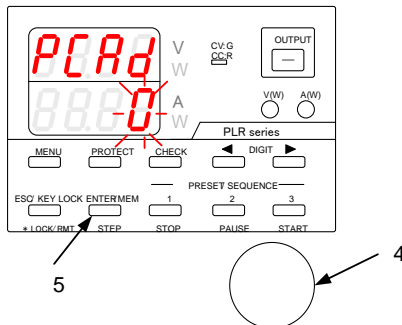

Checking the mode and address settings of the Interface card

Check the card type of the option card mounted on the unit and the card's settings.

Operation Procedure

1. Repeatedly press the MENU key until "IF--" is displayed in the voltage indicator.

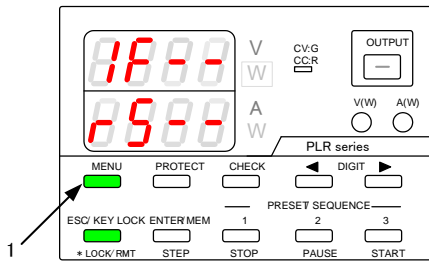

2. If the mounted interface card is the PLR-GU, PLR-LU, or PLR-RS (all of which allow the unit to be controlled remotely), the system address and PC address can be displayed by pressing the MENU key while "IF--" is displayed.

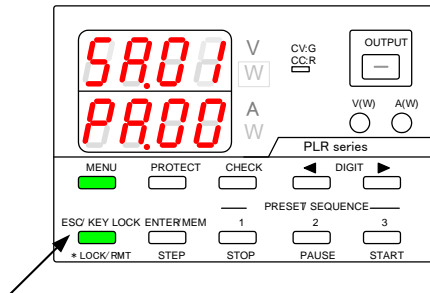

Screen Display of PLR card Information

PLR card type	Mode	Display
PLR-GU	GP-IB	
	USB	
PLR-LU	LAN	
	USB	
PLR ARC	None	
PLR-RS	None	
No card	None	

Display of the system address and PC address

The system address is the last two digits (following "SR.") displayed in the voltage indicator.

The PC address is the last two digits (following "PA.") displayed in the current indicator.

When using the PLR-GU or PLR-LU, if the system address is "1", the value of the PC address is displayed as a number.

In other cases, "PC.-" is displayed for the PC address.

GPIB connection

The following chart shows the wiring for when the GP-1B is used to connect PLR-GU to a PC:

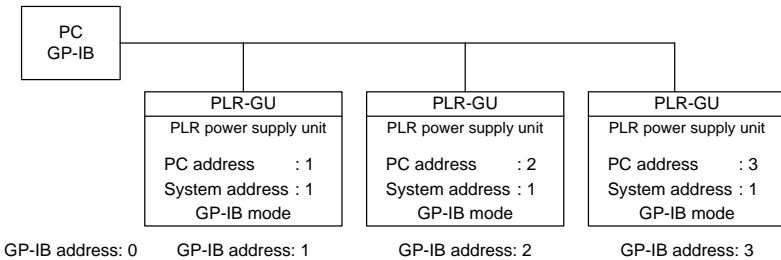

- Operation of the GP-IB has been verified by using a GP-IB board manufactured by National Instruments.
- LF (0x0A) and EOI are applied to set the delimiter.

Be sure to output the delimiter after outputting the commands and parameters.

Note that CR (0x0D) will be ignored. Be careful not to enter the wrong letters.

- At least half of the devices to which the GP-IB is connected must be powered on.

Turn on the power of all the devices.

- Two addresses are required for the address setting of the PLR power supply unit: the system address and PC address.

Make sure to specify "1" as the system address for the PLR unit connected to the PC.

- The GP-IB complies with the IEEE488-1978 specifications.

Interface actions are SH1, AH1, T6, TE0, L3, LE0, SR0, RL1, PP0, DC0, DT0, and C0.

USB connection

The following chart shows the wiring for when the USB is used to connect PLR-GU/PLR-LU to a PC:

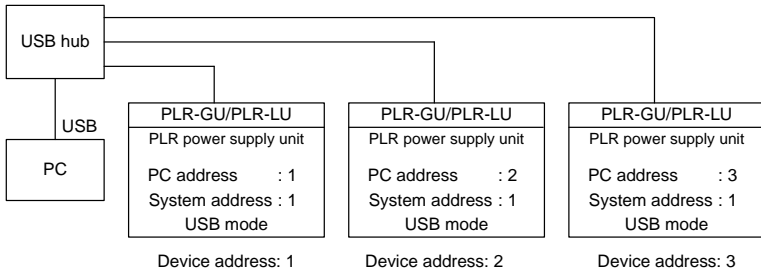

- PLR units support USB2.0 full speed. The USB ports on a PC can be used.
- The dedicated device driver and API provided by us need to be installed and configured on your PC. Visit our website to download the device driver and API.

It does not support USBTMC.

- This device driver does not support the suspension or sleep modes from the PC side.
- The environment in which a USB is used is extremely susceptible to external noise, which may cause the USB to malfunction.

Install the USB in manner that minimizes the effect of noise on the communication pathway, and make sure to implement countermeasures against noise.

- When a PLR series unit is used with USB, two addresses are required for the address setting: the system address and PC address. Make sure to specify “1” as the system address for the PLR unit connected to the PC.

RS-232 connection

The following chart shows the wiring for when the RS-232C is used to connect PLR-RS to a PC or sequencer.

The RS-232C is one-to-one connection. One serial port is required for each of the units that are directly connected.

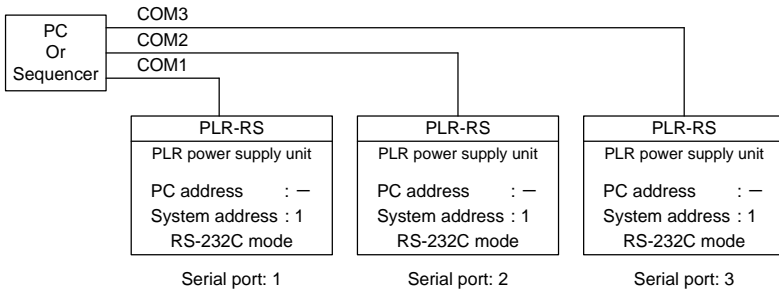

The factory default settings of RS-232C are as follows:

Baud rate: 9600bps; data length: 7bits; stop bit:1; even parity.

- In RS-232C communication, when a character string is sent from the PC to the power supply unit, the unit sends back the same string (echo back).
To read out the response, it is necessary to program the delimiter (LF: 0x0A) to separate the commands from the actual response signals.
- Flow control is not performed in the RS-232C communication.
If the PLR setting is specified, communication errors cannot be detected because character strings are not echoed back.

- The PC address is not applied when RS-232C is used to control the unit.

LAN connection

The following figure shows the wiring for connecting the PLR-LU to the PC via a LAN.

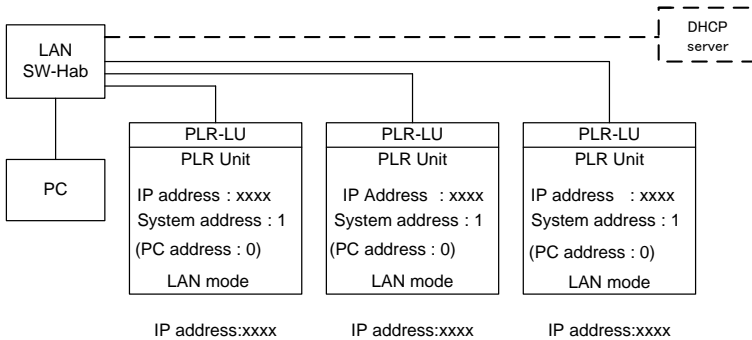

The LAN uses an XPort (manufactured by Lantronix) that supports Ethernet (IEEE 802.3) communication. A RJ45 connector (10BASE-T or 100BASE-TX) is used to connect the Ethernet interface.

- The following IP addresses are supported: fixed IP, DHCP, and Auto IP.
- TCP/IP for socket control, and COM port redirector for communication control.
- The delimiter for sending and receiving commands is LF (0x0A). Make sure to output the delimiter at the end of output.
- There are two addresses specified for the PLR power supply unit: system address and PC address. The setting of system address is "1".

The PC address is used to identify the device when DHCP or Auto IP is selected. When the IP address is a fixed IP, there is no need to configure the PC address.

- For details about configuring an automatic IP address or COM redirector, see the corresponding section in the operation manual. You can download the operation manual from our company's website.

Local bus connection

In a local bus connection, the master PLR power supply unit is used to communicate with the PC to control up to 30 slave PLR power supply units connected (in cascade arrangement) to the master unit via a dedicated modular cable.

The use of RS-485 signals in a local bus connection makes it possible to extend the distance between devices. However, in order to ensure stable control, the lengths of the cables used should be kept as short as possible.

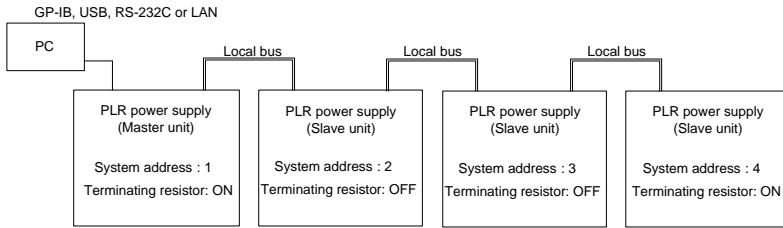

When specifying slave units, use the ADRS command to specify the system address number.

For the interface setting of the slave unit PLR-GU, the available values are USB or GP-IB.

A PLR-RS configured for RS-232C communication can be used as an interface for slave units.

Only the terminators at each end of the local bus should be on. The other terminators should be off.

In the figure above, the terminators for system addresses 1 and 4 are set to "ON". The rest are set to "OFF".

PLR card	Setting	Master unit	Intermediate slave unit	End of slave unit
PLR-GU	System address	1	2 to 31	
	PC address	0 to 31	Cannot be specified	
	PLR card mode setting	USB or GPIB	Not used. USB or GPIB can be specified.	
	PLR card terminator	ON	OFF	ON

PLR-RS	System address	1	2 to 31	
	PC address	Cannot be specified	Cannot be specified	
	PLR card mode setting	RS-232C	RS-232C	
	PLR card terminator	ON	OFF	OFF
PLR-LU	System address	1	2 to 31	
	PC address	0 to 31	Cannot be specified	
	PLR card mode setting	USB or LAN	Not used. USB or LAN can be specified.	
	PLR card terminator	ON	OFF	ON

Communication Control

Communication commands table

If a digital PLR board has been installed in the PLR supply unit, the commands are as follows:

Category	Item	Command Name	Setting	Query	Page
Output setting	Voltage setting	VOLT	Available	Available	183
	Current setting	AMP	Available	Available	183
	Modifying the set value of the protective function	OVP	Available	Available	184
	Modifying the set value of the protective function	UVP	Available	Available	184
	Modifying the set value of the protective function	OCP	Available	Available	185
	Output function	OUTPUT	Available	Available	185
	Status request	XSTATUS	-	Available	186
Function setting	Saving and recalling the set voltage and current in PRESET	PRESET	Available	Available	187
	Saving and recalling the set voltage and current in PRESET	SETPRE	Available	-	187
	Saving and recalling the set voltage and current in PRESET	PREVOLT	Available	Available	187
	Saving and recalling the set voltage and current in PRESET	PREAMP	Available	Available	188
	Displaying the power in the voltage & current indicators	MONDSP	Available	Available	189

	Output setting when the power is turned on	DSPY	Available	Available	189
	Switching between the set voltage & current display and the output voltage & current display	CHECK	Available	Available	190
	Setting CC priority mode	CCPRIO	Available	Available	190
	Setting the output off timer	OFFTM	Available	Available	191
	Setting the automatic cancellation time for the setting menu display	ESC	Available	Available	191
	Setting the main relay	POWER	Available	Available	192
	Key lock / local function	GTL	Available	-	192
	Setting local lock out	LLO	Available	-	193
	Setting the sequence operation	PONSEQ	Available	Available	193
	Recalling preset values when the power is turned on	PONPRE	Available	Available	194
	Output setting when the power is turned on	PONOUT	Available	Available	194
	Main relay setting when the power is turned on	PONPOW	Available	Available	195
	Notification setting 1	MASK	Available	Available	195
	Notification setting 2	AMASK	Available	Available	197
	Notification setting 3	SMASK	Available	Available	198
	Alarm	ALM	-	Available	199
	Alarm	EXIT_ALM	Available	-	199
Sequence System	Sequence operation	SCLR	Available	-	199
	Sequence operation	XSWRITE	Available	-	200
	Sequence operation	XSREAD	-	Available	201
	Sequence operation	SSADR	Available	Available	202

Sequence operation	SEADR	Available	Available	202
Sequence operation	SMODE	Available	Available	203
Sequence operation	SCYCLE	Available	Available	203
Sequence operation	CHGSEQ	Available	-	204
Sequence operation	CHGNORM	Available	-	204
Automatic execution of the sequence program	SSTART	Available	Available	205
Pausing and restarting the sequence program	SSTOP	Available	Available	205
Pausing and restarting the sequence program	SPAUSE	Available	Available	206
Manual execution of the sequence program	SSTEP	Available	Available	206
Reset	*RST	Available	-	207
Reset	RESET	Available	-	208
Reading out status byte	*STB	-	Available	208
Reading out product information	*IDN	-	Available	210
Model and specifications query	MODEL	-	Available	210
Designating local bus device	ADRS	Available	Available	211
Unit product name query	UNIT?	-	Available	212
Query-dedicated PC address for device identification when controlled by a LAN	LPCAD?	-	Available	211

Automatic message output

The PLR series unit is equipped with a function that outputs response messages independently of communication commands when a status change occurs. Output response messages can be selected by using the notification setting commands. As

parameters, the response message contains the system address of the unit on which a status change has occurred, and the information about the status change. The table below describes the different status changes and response messages that are output.

◆ For details about commands to enable/disable response messages, see the following sections:

Notification setting 1 (MASK)

Notification setting 2 (AMASK)

Notification setting 3 (SMASK)

All messages are disabled by default when the power is turned on.

This is normally used for the message receiving stand-by function in RS-232C communication or other communication modes.

Status Change	Response Message	Parameter 1	Parameter 2
Alarm occurrence	ALARM	System address	1: Occurrence of hardware alarm 2: Occurrence of under-voltage protection 3: Occurrence of over-voltage protection 4: Occurrence of over-current protection 5: Occurrence of other alarms
Error occurrence	ERROR	System address	1: Occurrence of command error 2: Occurrence of parameter error 3: Occurrence of execution error 4: Occurrence of warning
CV/CC mode change	SRCC	System address	0: CC mode → CV mode 1: CV mode → CC mode
Sequence end	END	System address	1: Completion

Sequence pause	PAUSE	System address	1: Completion
----------------	-------	----------------	---------------

Command format

Communication commands consist of general alphanumeric characters and symbols, and a header that is the abbreviation of a function. Each header is followed by a space and a parameter. No distinction is made between capital and lowercase letters, but all letters are converted to capital letters for the sake of processing.

<Example>	Voltage setting			
	VOLT		5.12	LF
	Header	Space	Parameter	Delimiter

Parameters are specified with an integer number, decimal number, and character string. Decimal places are rounded off according to the actual setting resolution. If there are several parameters, they should be marked off with a comma (,).

If a parameter that should be specified with an integer number is specified with a decimal, an error occurs. Make sure to correctly specify parameters.

Query commands feature a question mark (?) immediately after the function name header. Do not insert a space between the question mark and header, otherwise an error will occur.

The response to a query command will be the command and its parameter.

<Example>	Voltage setting query			
	VOLT	LF		
	Header	Delimiter		
<Example>	Voltage setting response			
	VOLT	—	5.12	LF
	Header	Space	Parameter	Delimiter

When querying an item that has a parameter, insert a space and the items' parameter after the question mark (?)

For commands that require a parameter, normal operation cannot be done if the parameter is omitted or incomplete. Make sure to input a complete parameter.

In addition, inserting a space before and/or after a command may impede normal operation.

Do not insert unnecessary spaces.

<Example>	Voltage setting query of PRESET 1			
	PREVOLT?	___	1	LF
	Header	Space	Parameter	Delimiter
<Example>	Voltage setting response of PRESET 1			
	PREVOLT	___	1,5.12	LF
	Header	Space	Parameter	Delimiter

When communicating from a PC to a slave unit on the local bus, the local bus designation command (ADRS) should be used to designate a system address for the slave unit.

The default system address is "1", which is the setting for the master unit.

Commands

Voltage setting (VOLT)

This command sets or queries the output voltage.

Setting	VOLT x1	Sets the output voltage.
Application example	VOLT 5.00	Sets the output voltage to 5.00V.
Query	VOLT?	Queries the output voltage setting.
Response example	VOLT 5.00	Indicates the set output voltage is 5.00V.

Remarks "x1" is a decimal or integer number. Digits less than the setting resolution are rounded off.

- For details about the setting range, see "SPECIFICATIONS" on page 218.

If the set value exceeds the range, the maximum value will be given.

Current setting (AMP)

This command sets or queries the output current.

Setting	AMP x1	Sets the output current.
Application example	AMP 5.00	Sets current to 5.00A.
Query	AMP?	Queries the output current setting.
Response example	AMP 5.00	Indicates the set output current is 5.00A.

Remarks "x1" is a decimal or integer number. Digits less than the setting resolution are rounded off.

- For details about the setting range, see "SPECIFICATIONS" on page 218.

If the set value exceeds the range, the maximum value will be given.

OVP setting (OVP)

This command sets or queries the OVP (over-voltage protection) value.

Setting	OVP x1	Sets the OVP.
Application example	OVP 5.00	Sets the OVP value to 5.00V.
Query	OVP?	Queries the OVP value.
Response example	OVP 5.00	Indicates the set OVP value is 5.00V.

Remarks "x1" is a decimal or integer number. Digits less than the setting resolution are rounded off.

- For details about the setting range, see "SPECIFICATIONS" on page 218.

If the set value exceeds the range, the maximum value will be given.

UVP setting (UVP)

This command sets or queries the UVP (under-voltage protection) value.

Setting	UVP x1	Sets the UVP value.
Application example	UVP 5.00	Sets the UVP value to 5.00V.
Query	UVP?	Queries the UVP value.

Response example	UVP 5.00	Indicates the set UVP value is 5.00V.
------------------	----------	---------------------------------------

Remarks "x1" is a decimal or integer number. Digits less than the setting resolution are rounded off.

- For details about the setting range, see "SPECIFICATIONS" on page 218.

If the set value exceeds the range, the maximum value will be given.

OCP setting (OCP)

This command sets or queries the OCP (over-current protection) value.

Setting	OCP x1	Sets the OCP value.
Application example	OCP 5.00	Sets the OCP value to 5.00A.
Query	OCP?	Queries the OCP value
Response example	OCP 5.00	Indicates the set OCP value is 5.00A.

Remarks "x1" is a decimal or integer number. Digits less than the setting resolution are rounded off.

- For details about the setting range, see "SPECIFICATIONS" on page 218.

If the set value exceeds the range, the maximum value will be given.

Output setting (OUTPUT)

This command sets and queries the output on/off setting.

Setting	OUTPUT x1	x1: Output status 0: Output off 1: Output on
---------	-----------	--

Application example	OUTPUT 1	Turns the output on.
Query	OUTPUT?	Queries the output setting.
Response example	OUTPUT 0	Indicates the output is off.

Remarks

Status query (XSTATUS)

This command queries the output status and set values.

Query	XSTATUS?	Queries the output status.
Response form	XSTATUS x1,x2,x3,x4,x5,x6,x7,x8,x9	
	x1:	Output status 0: Output off; 1: Output on;
	x2:	CV/CC status 0: CV mode; 1: CC mode; 2: Other/output off
	x3:	Output voltage
	x4:	Output current
	x5:	Set voltage
	x6:	Set current
	x7:	Set OVP (over-voltage protection) value
	x8:	Set UVP (under-voltage protection) value
	x9:	Set OCP (over-current protection) value
Response example	XSTATUS 1,0,5.15,3.10,5.15,2.10,10.2,-0.5,4.0 Output on, CV mode, Output 5.15V/3.10A, Set values: 5.15V/2.10A,OVP:10.2V/UVP:-0.5V/OCP:4.0A	

Remarks

Recalling preset setting (PRESET)

This command recalls preset settings and queries the preset status.

Setting	PRESET x1	x1: PRESET No. (1, 2, or 3)
Application example	PRESET 1	Recalls PRESET 1.
Query	PRESET?	Queries the preset status.
Response example	PRESET 0	0: Not in PRESET. 1: PRESET 1 is recalled. 2: PRESET 2 is recalled. 3: PRESET 3 is recalled.

Remarks If a preset setting is recalled and then the voltage or current setting is modified, the preset setting is lost.

Recalling preset setting (PRESET)

This command saves the set voltage and current values in preset memory.

Setting	SETPRE x1	x1: PRESET No. (1, 2, or 3)
Application example	SETPRE 1	Saves the set current and voltage values in PRESET 1.

Remarks Queries cannot be made.

Preset voltage setting (PREVOLT)

This command saves the set voltage directly to the preset memory, and queries the preset status.

Setting	PREVOLT x1,x2	x1: PRESET No. (1, 2, or 3) x2: Set voltage value
---------	---------------	--

Application example	PREVOLT 1,3.15	Saves 3.15V as the set voltage value in PRESET 1.
Query	PREVOLT? x1	x1: PRESET No. (1, 2, or 3)
Response form	PREVOLT x1,x2	x1: PRESET No. (1, 2, or 3) x2: Set voltage value
Response example	PREVOLT 1,3.15	Indicates 3.15V is the set voltage value saved in PRESET 1.

Remarks

- For details about the setting range, see “SPECIFICATIONS” on page 218.

Preset current setting (PREAMP)

This command saves the set current directly to the preset memory, and queries the preset status.

Setting	PREAMP x1,x2	x1: PRESET No. (1, 2, or 3) x2: Set current value
Application example	PREAMP 1,3.15	Saves 3.15A as the set current value for PRESET 1.
Query	PREAMP? x1	x1: PRESET No. (1, 2, or 3)
Response form	PREAMP x1,x2	x1: PRESET No. (1, 2, or 3) x2: Set current value
Response example	PREAMP 1,3.15	Indicates 3.15A is the set current value saved in PRESET 1.

Remarks

- For details about the setting range, see “SPECIFICATIONS” on page 218.

Power monitor display setting (MONDSP)

This command changes the power monitor display.

Setting	MONDSP x1	x1: Monitor display setting 0: Voltage & current display 1: Voltage & power display 2: Power & current display
Application example	MONDSP 1	Sets the voltage & power display.
Query	MONDSP?	Queries the monitor display status.
Response example	MONDSP 0	0: Displays the voltage & current. 1: Displays the voltage & power. 2: Displays the power & current.

Remarks

Power-off display setting (DSPY)

This command sets the display for when the output is off.

Setting	DSPY x1	x1: Display change setting 0: Only set values are displayed while the output is off. 1: Display can be switched between the set values and output values while the output is off.
Application example	DSPY 1	Specify whether the display can be switched between the set values and output values while the output is off.
Query	DSPY?	Queries the display setting.

Response example	DSPY 0	0: Only set values are displayed while the output is off. 1: Indicates the display can be switched between the set/output values while the output is off.
------------------	--------	--

Remarks

Monitor display switching (CHECK)

This command switches between the set/output values of the voltage & current monitor display.

Setting	CHECK x1	x1: Display change setting 0: Output value display 1: Set value display
Application example	CHECK 1	Sets the set value display.
Query	CHECK?	Queries the status.
Response example	CHECK 0	0: Displays the output values. 1: Displays the set values.

Remarks If display switching has been disabled for when the output is off, the display cannot be changed.

CC priority mode setting when the output is turned on (CCPRIO)

This command sets the CC (constant-current) priority mode for when the output is turned on.

Setting	CCPRIO x1	x1: CC priority mode setting for when the output is turned on. 0: CV priority mode 1: CC priority mode
Application example	CCPRIO 1	Sets CC priority mode.

Query	CCPRIO?	Queries the status.
Response example	CCPRIO 0	0: CV priority mode. 1: CC priority mode.

Remarks

Output off timer setting (OFFTM)

This command sets the off timer and queries the off timer setting.

Setting	OFFTM x1/x2	Sets the off timer. The time is set in hour/min.
Application example	OFFTM 8/30	Sets 8 hours 30 min for the off timer.
Query	OFFTM?	Queries the set time of the off timer.
Response example	OFFTM 8/30	Indicates the set time of the off timer is 8 hours 30 min.

Remarks The settable hour range is from 0 to 10000 hours, and the settable minute range is from 0 to 59 minutes.

 The set time of the off timer cannot be 0 hours 0 min.

Automatic cancellation time setting for the setting menu display (ESC)

This command sets and queries the automatic cancellation time.

Setting	ESC x1	x1: Sets the automatic cancellation time; integer from 1 to 10.
Application example	ESC 5	Sets 5 min as the automatic cancellation time for the display.
Query	ESC?	Queries the automatic cancellation time for the display.

Response example	ESC 5	Indicates 5 min has been set as the automatic cancellation time for the display.
------------------	-------	--

Remarks

Main relay setting (POWER)

This command sets the main relay and queries the main relay status.

Setting	POWER x1	x1: Sets the main relay operation. 0: Turns the main relay off. 1: Turns the main relay on.
Application example	POWER 1	Turns the main relay on.
Query	POWER?	Queries the on/off status of the main relay.
Response example	POWER 1	1: Indicates the main relay is on. 0: Indicates the main relay is off.

Remarks

Unlocking (GTL)

This command cancels the panel key lock.

Setting	GTL	No parameter.
This command disables panel unlocking.	This command disables panel unlocking.	This command disables panel unlocking.

Remarks

Local lock out setting (LLO)

This command cancels the panel key lock.

Setting	LLO	No parameter.
Application example	LLO	Disables use of the ESC for remotely unlocking the operation panel. Once local lock out is set, it cannot be cancelled until the power is turned off.

Remarks

Sequence operation setting when the power is turned on (PONSEQ)

This command sets and queries the sequence operation for when the power is turned on.

Setting	PONSEQ x1	x1: Specifies whether to perform a sequence operation when the power is turned on. 0: Specifies normal operation. 1: Specifies sequence operation.
Application example	PONSEQ 1	Specifies a sequence operation to start from the next time the power is turned on.
Query	PONSEQ?	Queries the sequence operation setting for when the power is turned on.
Response example	PONSEQ 1	Indicates that a sequence operation has been selected.

Remarks

Preset setting when the power is turned on (PONPRE)

This command sets and queries the preset recall operation for when the power is turned on.

Setting	PONPRE x1	x1: Specifies whether to perform a recall operation when the power is turned on. 0: Set values are for when the power was last turned off. 1: Recalls PRESET 1. 2: Recalls PRESET 2. 3: Recalls PRESET 3.
Application example	PONPRE 1	Recalls PRESET 1 when the power is turned on.
Query	PONPRE?	Queries the preset recall setting for when the power is turned on.
Response example	PONPRE 1	Indicates PRESET 1 is recalled when the power is turned on.

Remarks

Output setting when the power is turned on (PONOUT)

This command sets and queries the output setting for when the power is turned on.

Setting	PONOUT x1	x1: Specifies whether to turn on the output when the power is turned on. 0: Output is not turned on. 1: Output is turned on.
Application example	PONOUT 1	Turns the output on when the power is turned on.

Query	PONOUT?	Queries the output on setting for when the power is turned on.
Response example	PONOUT 1	Indicates the output is turned on when the power is turned on.

Main relay setting when the power is turned on (PONPOW)

This command sets and queries the main relay setting for when the power is turned on.

Setting	PONPOW x1	x1: Specifies whether to turn on the main relay when the power is turned on. 0: Main relay is not turned on. 1: Main relay is turned on.
Application example	PONPOW 1	Turns on the main relay when the power is turned on.
Query	PONPOW?	Queries the main relay setting for when the power is turned on.
Response example	PONPOW 1	Indicates the main relay is turned on when the power is turned on.

Remarks

Notification setting 1 (MASK)

This command sets and queries the character string issued for alarm notification 1.

Setting	MASK x1	x1: Uses an 8 digit combination of 0 and 1 to enable/disable alarm notification 1.
---------	---------	--

	MASK xxxxxx1 :	Enable(1)/disable(0) hardware alarm notification.
	MASK xxxxxx1x :	Enable(1)/disable(0) OVP occurrence notification.
	MASK xxxxx1xx :	Enable(1)/disable(0) UVP occurrence notification.
	MASK xxxx1xxx :	Enable(1)/disable(0) CV/CC mode change notification.
	MASK xxx1xxxx :	Enable(1)/disable(0) command error notification.
	MASK xx1xxxxx :	Enable(1)/disable(0) parameter error notification.
	MASK x1xxxxxx :	Enable(1)/disable(0) execution error notification.
	MASK 1xxxxxxx :	Enable(1)/disable(0) warning notification.
Application example	MASK 00001000	Sends the CV/CC mode change notification.
Query	MASK?	Queries the alarm notification setting.
Response example	MASK 00001000	Alarm notification is issued when CV/CC mode is changed.
Remarks	<p>The message issued contains a header to identify the unit on the local bus, followed by the system address (%1) of the unit on which the alarm occurred, and the alarm type.</p> <p>The default setting is 00000000.</p>	

Hardware alarm	ALARM %1,1
OVP occurrence	ALARM %1,3
UVP occurrence	ALARM %1,2
CV mode → CC mode	SRCC %1,0
CC mode → CV mode	SRCC %1,1
Command error	ERROR %1,1
Parameter error	ERROR %1,2
Execution error	ERROR %1,3
Warning error	ERROR %1,4

Notification setting 2 (AMASK)

This command sets and queries the character string issued for alarm notification 2.

Setting	AMASK x1	x1: Uses an 8 digit combination of 0 and 1 to enable/disable alarm notification 2.
	AMASK 000000x1 : AMASK 0000001x :	Enable(1)/disable(0) other alarm notification. Enable(1)/disable(0) OCP occurrence notification.
Application example	AMASK 00000001	Sends an alarm notification when OCP occurs.
Query	AMASK?	Queries the alarm notification 2 setting.
Response example	AMASK 00000001	Issues an alarm notification when OCP occurs.
Remarks	The message issued contains a header to identify the unit on the local bus, followed by the system address (%1) of the unit on which the alarm occurred, and the alarm type. The default setting is 00000000.	

	Other alarm	ALARM %1,5
	OCP occurrence	ALARM %1,4

Notification setting 3 (SMASK)

This command sets and queries the character string issued for sequence status notification.

Setting	SMASK x1	x1: Uses an 8 digit combination of 0 and 1 to enable/disable sequence status notification.
	SMASK 000000x1 :	Enable(1)/disable(0) sequence pause notification.
	SMASK 0000001x :	Enable(1)/disable(0) sequence end notification.
Application example	SMASK 00000001	Sends a status notification when a sequence is paused.
Query	SMASK?	Queries the sequence status notification setting.
Response example	SMASK 00000001	Issues a status notification when a sequence is paused.
Remarks	The message issued contains a header to identify the unit on the local bus, followed by the system address (%1) of the unit on which the alarm occurred, and the alarm type.	
	The default setting is 00000000.	
	Sequence pause	PAUSE %1,1
	Sequence end	END %1,1

Querying alarm status (ALM)

This command queries alarm status.

Setting	EXIT_ALM	No parameter
Application example	EXIT_ALM	Reset alarm

Remarks

Alarm reset (EXIT_ALM)

This command resets alarms for recoverable conditions.

Setting	EXIT_ALM	No parameter
Application example	EXIT_ALM	Reset alarm

Remarks Resettable alarms are as follows:
 Front output terminal overcurrent
 Abnormal internal heat
 Abnormal output (115% or more of rated output)
 For other alarms, the power must be tuned off and then on again.

Clearing sequence programs (SCLR)

This command clears sequence programs.

Setting	SCLR x1,x2	Clears a sequence program specified within the range of x1, x2.
Application example	SCLR 1,10	Clears a sequence program from STEP 1 to STEP 10.

Remarks x2 must be a number that is equal to or greater than x1.

Reading out a sequence program (XSREAD)

This command requests a sequence program.

Query	XSREAD ? Requests sequence program data.
Response	XSREAD x1,x2,x3,x4,x5,x6,x7,x8,x9,x10 x1: STEP No. 1 - 1000 x2: Set voltage value x3: Set current value x4: Set OVP value x5: Set UVP value x6: Set OCP value x7: Output 0: Off, 1: On; x8: Duration hh/mm/ss/aaa hh : Set hour mm: Set minute ss : Set second aaa: Set m. second x9: Pause setting 0: No pause, 1: Pause x10: CC priority mode 0: Off, 1: On
Application example	XSREAD 1,3.00,5.00,10.0,0.0,10.0,1,0/0/10/500,0,0 STEP No. : 1 Set voltage : 3.0V Set current : 5.0A Set OVP : 10.0V Set UVP : 0.0V Set OCP : 10.0A Output : ON Duration : 10.5 sec. Pause : No pause CC priority mode : OFF
Remarks	Connection time is from 0/0/0/050 to 99/59/59/990.

Sequence start point setting (SSADR)

This command specifies the starting STEP No. of the sequence.

Setting	SSADR x1	x1: Specifies a number from 1 to 1000 as the starting STEP No. of the sequence.
Application example	SSADR 3	Sets STEP 3 as the start of the sequence.
Query	SSADR?	Queries the starting STEP of the sequence.
Response example	SSADR 5	Indicates the sequence is set to start at STEP 5.

Remarks

Sequence end point setting (SEADR)

This command specifies the ending STEP No. of the sequence.

Setting	SEADR x1	x1: Specifies a number from 1 to 1000 as the ending STEP No. of the sequence.
Application example	SEADR 3	Sets STEP 3 as the end of the sequence.
Query	SEADR?	Queries the ending STEP of the sequence.
Response example	SEADR 5	Indicates the sequence is set to end at STEP 5.

Remarks

Sequence execution mode setting (SMODE)

This command selects the sequence execution mode.

Setting	SMODE x1	0: Sets increase as the sequence. 1: Sets increase & decrease as the sequence. 2: Sets decrease as the sequence. 3: Sets decrease & increase as the sequence.
Application example	SMODE 0	Sets increase as the sequence execution.
Query	SMODE?	Queries the sequence execution mode.
Response example	SMODE 0	Indicates increase has been set as the sequence execution mode.

Remarks Numbers increase from the start STEP toward to the end STEP in increase mode and decrease from the end STEP toward to the start STEP in decrease mode.

Sequence repeat cycle setting (SCYCLE)

This command specifies the number of times that a sequence cycle is repeated.

Setting	SCYCLE x1	x1: Sets a number from 0 to 1000 as the number of times the sequence cycle is repeated. 0 indicates that the sequence cycle will be repeated infinitely.
Application example	SCYCLE 3	Sets 3 as the number of times the sequence cycle is repeated.

Query	SCYCLE?	Queries the set number of times the sequence cycle is repeated.
Response example	SCYCLE 5	Indicates that 5 has been set as the number of times the sequence cycle is repeated.

Remarks If the sequence execution mode is increase & decrease, the phase from increase to decrease is considered to be one cycle.

Sequence mode setting (CHGSEQ)

This command switches the operation mode to sequence operation mode.

Setting	CHGSEQ	Switches from panel operation mode to sequence mode.
Application example	CHGSEQ	

Remarks

Panel operation mode setting (CHGNORM)

This command switches the operation mode to panel operation mode.

Setting	CHGNORM	Switches from sequence mode to panel operation mode.
Application example	CHGNORM	

Remarks

Sequence start (SSTART)

This command starts the execution of the sequence.

Setting	SSTART	Starts the execution of the sequence.
Application example	SSTART	
Query	SSTART?	Queries the execution status of the sequence.
Response example	SSTART 0	Indicates the sequence is not being executed.
	SSTART 1	Indicates the sequence is being executed.

Remarks If the unit is not in sequence mode, an error will be issued. If no sequence program has been registered, commands will be ignored.

Sequence stop (SSTOP)

This command stops the sequence.

Setting	SSTOP	Stops the sequence.
Application example	SSTOP	
Query	SSTOP?	Queries the execution status of the sequence.
Response example	SSTOP 0	Indicates the sequence has not stopped.
	SSTOP 1	Indicates the sequence has stopped.

Remarks If the unit is not in sequence mode, an error will be issued.

Sequence pause (SPAUSE)

This command pauses the sequence.

Setting	SPAUSE	Pauses the sequence.
Application example	SPAUSE	
Query	SPAUSE?	Queries the pause status of the sequence.
Response example	SPAUSE 0	Indicates that sequence has not paused.
	SPAUSE 1	Indicates the sequence has paused.

Remarks If the unit is not in sequence mode, an error will be issued.

Sequence jump (SSTEP)

This command moves sequence steps forward or backward.

Setting	SSTEP x1	Moves sequence steps forward or backward. The setting range is from -1000 to 1000.
Application example	SSTEP 10	The sequence jumps forward 10 steps.
Query	SSTEP?	Queries the current step No. of the sequence.
Response example	SSTEP 3	Indicates the current step No. of the sequence is 3.

Remarks If the unit is not in sequence mode, an error will be issued.

Reading out the sequence execution status (SRUN)

This command queries the sequence execution status.

Query	SSTEP x1	Moves sequence steps forward or backward. The setting range is from -1000 to 1000.
	SRUNx1, x2, x3 x1: Status execution 0: Stopped 1: Executing 3: Paused x2: Current STEP No. x3: Current number of times the cycle is repeated	
	SRUN 1, 3, 2	Indicates the sequence is executing, the current STEP No. is 3, and that the sequence is in its 2nd cycle.

Remarks If the unit is not in sequence mode, “stopped” is issued.

Reset (*RST)

This command resets the PLR unit.

Setting	*RST	Resets the PLR unit to the initial status for when the power is turned on.
Application example	*RST	

Remarks

Function reset (RESET)

This command resets the unit to its factory defaults.

Setting	RESET x1	Resets the PLR unit. 0: Resets the unit to the initial status for when the power is turned on. 1: Initializes the panel settings. The sequence data and master-slave data are not to be modified. 2: Resets all settings to their factory defaults.
Application example	RESET 1	This command initializes the panel settings

Remarks Because the RESET command also resets the communication address, communication will be discontinued.

Reading out the status byte (*STB)

This command queries the status byte.

Query	*STB?	Queries the status byte.
Response form	*STB x1	

		<p>0, 64: An alarm for a recoverable condition has been issued or an OCP has occurred in the unit.</p> <p>1, 65: AC input alarm has occurred in the unit.</p> <p>2, 66: UVP has occurred in the unit.</p> <p>3, 67: OVP has occurred in the unit.</p> <p>4, 68: The unit has switched from CC mode to CV mode.</p> <p>5, 69: The unit has switched from CV mode to CC mode.</p> <p>6, 70: Sequence operation in the unit has stopped.</p> <p>7, 71: A command error has occurred in communication.</p> <p>8, 72: A parameter error has occurred in communication.</p> <p>9, 73: A run error has occurred in communication.</p> <p>10,74: A warning was issued during communication (out of range, etc.).</p> <p>13, 77: Sequence operation in the unit has paused.</p>
		<p>If another situation occurs before acquiring status byte, the previous status will be lost.</p>
Application example	*STB 68	<p>The unit has switched from CC mode to CV mode.</p>

Remarks

Reading out the product information (*IDN)

This command queries the device information.

Query	*IDN?	Queries the device information.
Response form	*IDN x1,x2,0,x3	
		x1: Company name x2: Product name x3: "0" Fixed x4: Version No.
Response example	*IDN GW INSTEK,PLR-Series,0,2.01	

Remarks

Querying the model and specifications (MODEL)

Queries the device information

Query	MODEL?	Queries device information.
Response form	MODEL x1,x2,x3	
		x1: Series No. 21: 6V series 22: 10V series 23: 20V series 24: 40V series 25: 60V series 26: 36V series x2: Maximum voltage x3: Maximum current
Response example	MODEL 22,10.25,41.00	Maximum voltage 10.25V, maximum current 41.00A

Remarks

Local bus setting (ADRS)

The command sets the system address of controlled units when they are connected via the local bus.

Setting	ADRS x1	Specifies a device in local bus.
Application example	ADRS 3	Controls the unit whose system address is "3".
Query	ADRS?	Queries the system address of the controlled unit.
Response example	ADRS 5	Indicates "5" is the system address of the unit controlled by the local bus.

Remarks If the assigned system address is "0", all the devices will operate independently of the local address (broadcast operation). If a query command that requests a response is used at this time, normal operation of the bus will be impeded. Avoid using a query command in this situation.

The system address of the unit connected to the PC should be "1".

Query-dedicated PC address for device identification when controlled by a LAN (LPCAD?)

Querying the device number used to identify the PC address.

Query	LPCAD?	Queries the product name of the unit.
Response form	LPCAD x1	-1: Query that is not LAN-based. 0 to 31: Registered PC address for the LAN.

Response example	LPCAD 0	
------------------	---------	--

Remarks Used to identify devices when the IP address is automatically allocated by the DHCP.

Returning the product name of the unit (UNIT?)

This command queries the product name of the unit.

Query	UNIT?	Queries the product name of the unit.
Response example	UNIT PLR20-18	Product name of the unit

Remarks

Cautions about Communication

Remember to observe the following points about communication:

- Do not use a long cable for communication.
- Keep the communication cable as far as possible from noise sources.
- For continuous communication that creates a heavy burden, conduct a long-term test to confirm that no conflicts occur.
- If local bus is used, set a longer wait period to avoid communication conflicts.
- If broadcast operation is performed in the local bus, avoid using query commands.
- When connecting to PC, pay attention to the potential difference and leakage current in the GND line.

Communication Specifications

PLR-RS

RS-232C	
Specification	Compatible with RS-232C
Date transfer speed	PLR 9600 [bps]
Setting	PLR Data: 7[bit], Stop bit: 1[bit], Parity: Even
Maximum code length	10[m]
Connector type	D-sub 9 pins, male
Applicable cable	Commercially available interlink cable (9 pins, female ↔ 9 pins, female)
Number of connectable units	1-to-1 connection only
Local bus	
Specification	Compatible with RS-485, dedicated protocol
Maximum code length	1.2[km]
Connector type	RJ-11 (6-pin modular)
Applicable cable	Dedicated modular cable
Terminator	Can be switched on/off by using a jumper pin. Only both ends of the cable should be on.
Number of ports	2 ports, no orientation

PLR-GU

USB	
Specification	Supports USB Revision 2.0, full speed
Connector type	USB series B
Device class	Dedicated device class. Device driver for Windows is available separately.
Vender code	0x098F
Product code	0x1007
Power supply	Self-power only
Number of connectable units	A maximum of 30 units via USB hub.
GPIB	
Specification	Compliant with IEEE488-1978 specifications.
Interface function	SH1,AH1,T6,L4,SR1,RL1,PP0,DC1,DT0,C0,E1
Address setting	Addresses can be freely set from 1 to 30.
Delimiter	LF and EOI
Listener function	Output conditions of controlled units can be set.
Talker function	The output status and settings of controlled units can be detected.
Service request function	The status report function is available.
Number of connectable units	A maximum of 14 units can be connected on a single bus.
Local bus	
Specification	Compatible with RS-485, dedicated protocol
Maximum code length	1.2[km]
Connector type	RJ-11 (6-pin modular)
Applicable cable	Dedicated modular cable
Terminator	Can be switched on/off by using a jumper pin. Only both ends of the cable should be on.
Number of ports	2 ports, no orientation

PLR-LU

USB

Specification	Supports USB Revision 2.0, full speed
Connector type	USB series B
Device class	Dedicated device class Device driver for Windows is available separately.
Vender code	0x2184
Product code	0x0050
Power supply	Self-power only
Number of connected units	A maximum of 30 units via USB hub

LAN

Specification	XPort (Lantronix)
Protocol	TCP/IP, DHCP, HTTP, and Auto IP
Communication compatibility	Ethernet: IEEE 802.3
Ethernet interface	RJ45 (10BASE-T, 100BASE-TX)
Control method	Socket communication, virtual COM port control

Local bus

Specifications	Compatible with RS-485, dedicated protocol
Maximum code length	1.2 [km]
Connector type	RJ-11 (6-pin modular)
Applicable cable	Dedicated modular cable
Terminator	Can be switched on/off by using a jumper pin. Only both ends of the cable should be on.
Number of ports	2 ports, no orientation

※ In regards to the local bus, PLR-GU, PLR-RS and PLR-LU share the same specification, thus they can be used together.

※ We offer dedicated modular cables. Please contact our service center or one of our sales branches.

Voltage Setting

Rated voltage [V]	Output setting range [V]	Over-voltage protection range [V]	Under-voltage protection range [V]
20	0.00 ~ 20.50	2.0 ~ 22.0	-1.0 ~ 22.0
36	0.00 ~ 36.90	3.6 ~ 39.6	-1.0 ~ 39.6
40	0.00 ~ 41.00	4.0 ~ 44.0	-1.0 ~ 44.0
60	0.00 ~ 60.15	6.0 ~ 66.0	-1.0 ~ 66.0
72	0.00 ~ 72.00	7.2 ~ 79.2	-1.0 ~ 79.2
120	0.0 ~ 123.0	12.0 ~ 132.0	-1.0 ~ 132.0

* Rated voltages for serial master-slave arrangement.

Current Setting

Rated current [A]	Output setting range [A]	Over-current protection range [A]
6	0.00 ~ 6.15	0.3 ~ 6.6
10	0.00 ~ 10.25	0.5 ~ 11.0
12	0.00 ~ 12.30	0.6 ~ 13.2
18	0.00 ~ 18.45	0.9 ~ 19.8
20	0.00 ~ 20.50	1.0 ~ 22.0
24	0.00 ~ 24.60	1.2 ~ 26.4
30	0.00 ~ 30.75	1.5 ~ 33.0
36	0.00 ~ 36.90	1.8 ~ 39.6
40	0.00 ~ 41.00	2.0 ~ 44.0
54	0.00 ~ 55.35	2.7 ~ 59.4
60	0.00 ~ 61.50	3.0 ~ 66.0
72	0.00 ~ 73.80	3.6 ~ 79.2
108	0.0 ~ 110.7	5.4 ~ 118.8

* Rated currents for both serial and parallel master-slave arrangements.

SPECIFICATIONS

Individual Specifications

PLR 360W

Model	PLR 20-18	PLR 36-10	PLR 60-6
Output			
Rated Power	360W		
Output voltage	0 V - 20 V	0 V - 36 V	0 V - 60 V
Voltage setting resolution	10 mV		
Voltage setting accuracy	$\pm(0.5\%SET+0.5\%F.S)$: 23°C \pm 5°C, after 30-minute aging		
Output current	0 A - 18 A	0 A - 10 A	0 A - 6 A
Current setting resolution	10 mA	10 mA	1 mA
Current setting accuracy	$\pm(1\%SET+1\%F.S)$: 23°C \pm 5°C, after 30-minute aging		
Constant-voltage Characteristics			
Linear Regulation ¹	0.005%FS+1mV		
Load Regulation ²	0.005%FS+2mV		
Ripple ³	0.5 mVrms		
Noise (p-p) ⁴	30 mVp-p		
Rise Time: No load/rated load (TYP)	50ms/50ms		
Fall Time: No load/rated load (TYP)	250ms/50ms	250ms/50ms	600ms/150ms
Transient response (TYP)	100 μ s		
CV temperature coefficient	\pm 100ppm/°C		

Model	PLR 20-18	PLR 36-10	PLR 60-6
Constant-current Characteristics			
Linear Regulation ¹	5 mA	1 mA	1 mA
Load Regulation ⁵	5 mA		
Ripple ³	10 mArms	5 mArms	5 mArms
CC temperature coefficient	±100ppm/°C		
Indicators			
Voltage display range	-10%FS~+110%FS		
Voltage display accuracy	±(0.1%rdg+2digit): 23°C±5°C/after 30-minute aging		
Current display range	0%FS~+110%FS		
Current display accuracy	±(0.5%rdg+2digit): 23°C±5°C / after 30-minute aging		
Power display range	0%FS~+110%FS		
Power display resolution	0.1W		
Power display accuracy	±(0.7%rdg+1.5%F.S): 23°C±5°C, after 30-minute aging		
Power Consumption: 100VAC input, rated power output			
Input voltage	AC100V - 240V, 50Hz - 60Hz, single-phase		
Power consumption (TYP)	570 VA	520 VA	510 VA
Power factor (TYP)	0.99		

1. For ±10% fluctuation of the input voltage.
2. Measures remote sensing terminal for fluctuations of output current of 0% to 100%.
3. Measures at a frequency of 5 Hz to 1 MHz, by RMS.
4. Noise measured by 20 MHz oscilloscope.
5. For fluctuations of 0% to 100%.

PLR 720W

Model	PLR 20-36	PLR 36-20	PLR 60-12
Output			
Rated Power	720W		
Output voltage	0 V - 20 V	0 V - 36 V	0 V - 60 V
Voltage setting resolution	10 mV		
Voltage setting accuracy	±(0.5%SET+0.5%F.S): 23°C±5°C, after 30-minute aging		
Output current	0 A - 36 A	0 A - 20 A	0 A - 12 A
Current setting resolution	10 mA		
Current setting accuracy	±(1%SET+1%F.S): 23°C±5°C, after 30-minute aging		
Constant-voltage Characteristics			
Linear Regulation ¹	0.005%FS+1mV		
Load Regulation ²	0.005%FS+2mV		
Ripple ³	0.5 mVrms		
Noise (p-p) ⁴	30 mVp-p		
Rise Time: No load/rated load (TYP)	50ms/50ms		
Fall Time: No load/rated load (TYP)	250ms/50ms	250ms/50ms	600ms/150ms
Transient response (TYP)	100µs		
CV temperature coefficient	±100ppm/°C		
Constant-current Characteristics			
Linear Regulation ¹	10 mA	5 mA	5 mA
Load Regulation ⁵	5 mA		
Ripple ³	10 mArms		
CC temperature coefficient	±100ppm/°C		

Model	PLR 20-36	PLR 36-20	PLR 60-12
Indicators			
Voltage display range	-10%FS ~ +110%FS		
Voltage display accuracy	$\pm(0.1\%rdg+2digit)$: 23°C \pm 5°C/after 30-minute aging		
Current display range	0%FS ~ +110%FS		
Current display accuracy	$\pm(0.5\%rdg+2digit)$: 23°C \pm 5°C / after 30-minute aging		
Power display range	0%FS ~ +110%FS		
Power display resolution	0.1W		
Power display accuracy	$\pm(0.7\%rdg+1.5\%F.S)$: 23°C \pm 5°C, after 30-minute aging		
Power Consumption: 100VAC input, rated power output			
Input voltage	AC100V - 240V, 50Hz - 60Hz, single-phase		
Power consumption (TYP)	1100 VA	1050 VA	1000 VA
Power factor (TYP)	0.99		

1. For $\pm 10\%$ fluctuation of the input voltage.
2. Measures remote sensing terminal for fluctuations of output current of 0% to 100%.
3. Measures at a frequency of 5 Hz to 1 MHz, by RMS.
4. Noise measured by 20 MHz oscilloscope.
5. For fluctuations of 0% to 100%.

Common Specifications of PLR Series

Over-voltage protection	Setting range: 10% to 110% FS, Setting resolution: 10 times of minimum display resolution. Activates when output voltage exceeds set OVP value: Hardware detection.
Under-voltage protection	Setting range: -1V to 110% FS, Setting resolution: 10 times of minimum display resolution. Activates when output voltage falls below the set UVP value: Software detection.
Over-current protection	Setting range: 5% to 110% FS, Setting resolution: 10 times of minimum display resolution. Activates when output current exceeds set OCP value: Software detection.
Compensating voltage range of remote sensing	1.5V one way: Output power no greater than the rated voltage.
Grounding	Positive or negative grounding.
Protective functions	Over input voltage, under input voltage: Main relay off. Over current of front output, internal overheat, over output voltage, over output current: Output off.
Cooling method	Forced cooling: Fan speed proportionate to the temperature of the internal heat sink.
Operating temperature range	0°C to 40°C.
Operating humidity range	30% to 85%RH (No dew condensation).
Storage temperature range	-20°C to 60°C.
Storage humidity range	20% to 85%RH (No dew condensation).
Dielectric strength voltage	Primary-casing:1500VAC, 1min Primary-secondary: 2300VAC, 1min.
Insulation resistance	Primary-casing: 500VDC 30MΩ or more Secondary-casing: 500VDC 20MΩ or more.
To-GND voltage	±250VDC.
Outside dimensions [mm]	360W: 124(H)×140(W)×364(D) 720W: 124(H)×210(W)×364(D)
Maximum dimensions [mm]	360W: 139.5(H)×140(W)×415.5(D) 720W: 139.5(H)×210(W)×415.5(D)
Weight	360W: Approx.5.2kg 720W: Approx.7.5kg

PLR Series Compatible Specifications

Compatible specification ⁶	LVD ⁸	EN61010-1: 2010 (Edition 3) Indoor use / Max. altitude 2000m / Over-voltage category II / Pollution degree 2	
	EMC	EMS (MIN)	EN61326-1:2013
		EMI (class A)	EN61326-1:2013
Conditions for specification conformance ⁷		Use the unit with the power cable wound once around the accessory core.	
		Use the unit with a secure ground connection via the protective grounding terminal on the bottom face of the unit.	

6. Applicable only for units with the CE mark on the rear panel. NOT applicable for modified units.
7. Conditions for specification conformance when the optional board PLR-GU or PLR-RS is installed: The USB/GP-IB/RS-232C/modular cables used for connection must be less than 3m in length.

Conditions for specification conformance when the optional board PLR-GU or PLR-RS is installed: Both ends of the USB/modular cables to which a core (TDK : ZCAT2035-0930A-M or equivalent product) is attached must be wound twice.

8. If you do not connect the protective grounding terminal on the bottom face, it will no longer comply to CE conformity. See “Connecting the protective grounding terminal on the bottom face” on page 22 for details.

APPENDIX

Trouble Shooting

If the PLR power supply unit becomes defective, check the following items.

Phenomenon	Possible cause	Action
Power is not turned on even when the POWER switch is thrown. (The front panel LED is not lit.)	The AC cable is not connected securely or is broken.	Securely connect the AC cable. Or, replace the AC cable if it is broken.
	An error in the PLR power supply unit has caused the fuse to blow.	The internal fuse must be replaced. Please contact our service center.
	AC input voltage is too low.	Adjust the AC voltage.
"ALH" is displayed when the POWER switch is thrown.	The set voltage that is input in the PLR power supply unit exceeds the permissible AC input voltage range.	The permissible AC input voltage range is 100VAC to 240VAC, 50Hz to 60Hz.
"P-oF" is displayed when the POWER switch is thrown.	SW1-1 of the external analog board has been switched on.	Switch off the external analog board SW1-1.

<p>“ScAn Err” is displayed when the POWER switch is thrown in parallel master-slave connection.</p>	<p>The wrong number of power units has been set.</p>	<p>Correct the setting for the number of power units.</p>
	<p>The dedicated cable is not connected to the J1 connector on the rear panel.</p>	<p>Connect the dedicated cable to the J1 connector on the rear panel.</p>
	<p>A cable other than the dedicated cable is connected to the J1 connector on the rear panel.</p>	<p>Make sure to only use the dedicated cable.</p>
<p>No voltage is output, even when the output is turned on in serial master-slave connection.</p>	<p>The dedicated cable is not connected to the J1 connector on the rear panel.</p>	<p>Connect the dedicated cable to the J1 connector on the rear panel.</p>
	<p>A cable other than the dedicated cable is connected to the J1 connector on the rear panel.</p>	<p>Make sure to only use the dedicated cable.</p>
<p>No voltage is output, even when the output is turned on.</p>	<p>The current is set to 0.00 A in CC mode.</p>	<p>Increase the set current.</p>
<p>“ALIP” is displayed when the front output terminals are used.</p>	<p>A current of 20A or more is flowing to the load from the PLR power supply unit.</p>	<p>The current of the front output terminals is 20A or less. Use the rear output terminals.</p>
<p>“ALIP” is displayed when the output is turned on.</p>	<p>The remote sensing terminal is not connected to the load.</p>	<p>Connect the remote sensing terminal to the load.</p>

	The short bar to connect the output terminal and the remote sensing terminal is disconnected.	Use the short bar to connect the output terminal and the remote sensing terminal.
“ALII” is displayed when the PLR power supply unit is used.	Objects have been placed in the front or back of the PLR power supply unit, blocking intake from the front grill or exhaust from the rear of the unit.	Maintain a distance of at least 30 cm between objects and the front & rear panels.
	Lack of sufficient intake from the front grill due to dirt in the front grill’s dust filter.	Replace or clean the internal dust filter. If the PLR unit has been used for a few years, there may be dust and other particles that the dust filter cannot remove. If replacing or cleaning the internal dust filter fails to fix the problem, repair or recalibration of the unit may be required.
Voltage does not fall, even after the output has been turned off.	A capacitive load is connected to the PLR power supply unit.	Before touching the output terminals, use a voltmeter to measure the voltage of the unit’s output terminals to confirm voltage has fallen.
	Output HI-R function is turned on.	Turn off the output HI-R function.

Output voltage is unstable or excessive noise has been input.	Commercial frequency noise has been detected due to low AC input voltage.	Adjust the AC input voltage.
	There is a strong magnetic or electrical field nearby.	Take the proper countermeasures. Move the unit away from equipment that may produce a magnetic or electrical fields and twist the wires.

- Contact our service center if you encounter a phenomenon that is not described above, or if the problem persists even after the above causes have been eliminated.

Outside Dimensions

- 200W/360W model : Outside dimensions: 124mm (H) × 140mm (W) × 364mm (D) Weight: Approx. 5.2kg

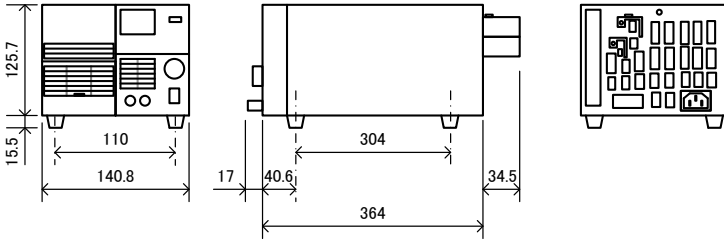

- 720W model : Outside dimensions: 124mm (H) × 210 mm (W) × 364mm (D) Weight: Approx. 7.5kg

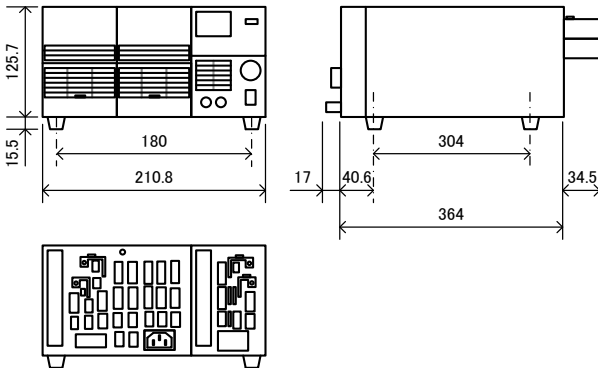

Declaration of Conformity

We

COMBINED TEST SOLUTIONS.

declare that the below mentioned products

Model Number: **PLR 20-18/ PLR 20-36/ PLR 36-10/ PLR 36-20/ PLR 60-6/ PLR 60-12**

are herewith confirmed to comply with the requirements set out in the Council Directive on the Approximation of the Law of Member States relating to Electromagnetic Compatibility (2014/30/EU), Low Voltage Equipment Directive (2014/35/EU), WEEE (2012/19/EU) and RoHS (2011/65/EU).

For the evaluation regarding the Electromagnetic Compatibility and Low Voltage Equipment Directive, the following standards were applied:

© EMC

EN 61326-1: EN 61326-2-1:	Electrical equipment for measurement, control and laboratory use -- EMC requirements (2013)	
Conducted & Radiated Emission EN 55011:2009+A1:2010	Electrical Fast Transients EN 61000-4-4: 2012	
Current Harmonics EN 61000-3-2: 2014	Surge Immunity EN 61000-4-5: 2006	
Voltage Fluctuations EN 61000-3-3: 2013	Conducted Susceptibility EN 61000-4-6: 2014	
Electrostatic Discharge EN 61000-4-2: 2009	Power Frequency Magnetic Field EN 61000-4-8: 2010	
Radiated Immunity EN 61000-4-3: 2006+A1:2008+A2:2010	Voltage Dip/ Interruption EN 61000-4-11: 2004	

© Safety

Low Voltage Equipment Directive 2014/35/EU	
Safety Requirements	EN 61010-1: 2010, EN 61010-2-030: 2010

Combined Test Solutions,
4 Commerce Way, Stanbridge Road,
Leighton Buzzard, LU7 4RW

T: 01525 374466
E: sales@ctstest.co.uk
W: www.ctstest.co.uk

