



AEL-5000 Series

AC & DC Electronic Load

FEATURES

- CC, Linear CC, CR, CV, CP and AC Rectifier Load Mode
 - Frequency Range : DC, 40~440Hz
 - Turbo Mode for 2 Times the Current and Power of Electronic Load within 1 Second
 - Eight Units Connected in Parallel up to 180kW for Single-phase and 540kW for Three-phase. Three-phase Delta or Wye Load Connection Can be Synchronized Control by One Master Unit
 - Loading and Unloading Angle Control; 0~359 Degree is Settable
 - Positive Half-cycle or Negative Half-cycle Loading
 - Supports SCR/TRIAC Current Phase Modulation Waveforms, 90 Degree Trailing Edge and Leading Edge
 - Optional Interface : GPIB 、 RS232 、 USB 、 LAN
-

AC & DC Electronic Load

AEL-5000 Series



AEL-5002-350-18.75 **AEL-5006-350-56** **AEL-5012-350-112.5** **AEL-5015-350-112.5** **AEL-5019-350-112.5** **AEL-5023-350-112.5**
AEL-5003-350-28 **AEL-5008-350-75** **AEL-5012-425-112.5** **AEL-5015-425-112.5** **AEL-5019-425-112.5** **AEL-5023-425-112.5**
AEL-5004-350-37.5 **AEL-5006-425-56**
AEL-5002-425-18.75 **AEL-5008-425-75**
AEL-5003-425-28
AEL-5004-425-37.5
AEL-5003-480-18.75
AEL-5004-480-28



MODEL	Power (W)		Current(Ampere)		Voltage(Volt)
	Turbo OFF	Turbo ON	Turbo OFF	Turbo ON	
AEL-5002-350-18.75	1875 W	3750W (x2)*	18.75 Arms / 56.25Apeak	37.5Arms/56.25Apeak (x2)*	50~350Vrms / 500Vdc
AEL-5003-350-28	2800W	5600W (x2)*	28 Arms / 84Apeak	56Arms/84Apeak (x2)*	
AEL-5004-350-37.5	3750 W	7500W (x2)*	37.5 Arms / 112.5Apeak	75.0Arms/112.5Apeak (x2)*	
AEL-5002-425-18.75	1875 W	3750W (x2)*	18.75 Arms / 56.25Apeak	37.5Arms/56.25Apeak (x2)*	
AEL-5003-425-28	2800W	5600W (x2)*	28 Arms / 84Apeak	56Arms/84Apeak (x2)*	50~425Vrms / 600Vdc
AEL-5004-425-37.5	3750 W	7500W (x2)*	37.5 Arms / 112.5Apeak	75.0Arms/112.5Apeak (x2)*	
AEL-5006-350-56	5600 W	11200W (x2)*	56.0 Arms / 168Apeak	112.0Arms/ 168Apeak (x2)*	
AEL-5008-350-75	7500 W	15000W (x2)*	75.0 Arms / 225Apeak	150.0Arms/225Apeak (x2)*	
AEL-5012-350-112.5	11250W	22500W (x2)*	112.5 Arms / 337.5Apeak	225Arms/337.5Apeak (x2)*	50~350Vrms / 500Vdc
AEL-5015-350-112.5	15000W	30000W (x2)*	112.5 Arms / 337.5Apeak	225Arms/337.5Apeak (x2)*	
AEL-5019-350-112.5	18750W	37500W (x2)*	112.5 Arms / 337.5Apeak	225Arms/337.5Apeak (x2)*	
AEL-5023-350-112.5	22500W	45000W (x2)*	112.5 Arms / 337.5Apeak	225Arms/337.5Apeak (x2)*	
AEL-5006-425-56	5600 W	11200W (x2)*	56.0 Arms / 168Apeak	112.0Arms/ 168Apeak (x2)*	50~425Vrms / 600Vdc
AEL-5008-425-75	7500 W	15000W (x2)*	75.0 Arms / 225Apeak	150.0Arms/225Apeak (x2)*	
AEL-5012-425-112.5	11250W	22500W (x2)*	112.5 Arms / 337.5Apeak	225Arms/337.5Apeak (x2)*	
AEL-5015-425-112.5	15000W	30000W (x2)*	112.5 Arms / 337.5Apeak	225Arms/337.5Apeak (x2)*	
AEL-5019-425-112.5	18750W	37500W (x2)*	112.5 Arms / 337.5Apeak	225Arms/337.5Apeak (x2)*	50~480Vrms / 700Vdc
AEL-5023-425-112.5	22500W	45000W (x2)*	112.5 Arms / 337.5Apeak	225Arms/337.5Apeak (x2)*	
AEL-5003-480-18.75	2800W	5600W (x2)*	18.75 Arms / 56.25Apeak	37.5Arms/56.25Apeak (x2)*	
AEL-5004-480-28	3750 W	7500W (x2)*	28 Arms / 84Apeak	56Arms/84Apeak (x2)*	

* Power and current boost rate of Turbo ON

AC & DC Electronic Load

FEATURES

- 4 digit V / A/W Meter · display the Voltage (V_{rms} , V_{peak} , $V_{max.}$, $V_{min.}$) · Current (I_{rms} , I_{peak} , $I_{max.}$, $I_{min.}$) · Watt, Voltampere (VA) · Frequency · Crest Factor · Power Factor · Total Harmonic Distortion of Voltage (VTHD), Voltage Harmonic (VH) · Total Harmonic Distortion of Current (ITHD), Current Harmonic (IH)
- CC, Linear CC, CR, CV, CP and AC Rectifier Load mode
- Crest factor range : 1.414~5.0
- Power factor (PF) range : 0~1 lead or (-1~0) lag
- Built-in function test modes include UPS Efficiency, PV Inverter Efficiency, UPS Back-up time, Battery Discharge time, UPS transfer time, Fuse/Breaker Trip/Non-Trip, Short circuit , OCP, OPP test modes
- Turbo mode is able to increase to 2 times the current and power of electronic load in a short period which is the most suitable for Fuse / Breaker test and short circuit, OCP, OPP test of AC power supply
- Time measurement can be applied to batteries, UPS, fuses and circuit breakers and other tests
- Support on-load boot; at first set Load ON to support on-load boot, inverter or uninterruptible power supply is turned on directly with the set load current, used to verify whether the starter is stable when the Inverter is connected.
- Supports the loading and unloading angle control; the loading and unloading angle control, the full range of 0-359 degrees can be set to verify whether the Inverter output voltage transient response is stable when the actual electrical plugging and unplugging, and whether Overshoot/Undershoot is within the allowable range.
- Support positive half-cycle or negative half-cycle loading; used to verify whether the Inverter output voltage remains stable when the actual appliance has only positive half-cycle or negative half-cycle load current.
- Supports SCR/TRIAC current phase modulation waveforms, 90 degree Trailing edge and Leading Edge.
- Supports the Inrush Current of the inverter at startup and the Surge Current test when the load is suddenly plugged in (Hot Plug-in) during testing.
- Frequency Range : DC, 40~440Hz
- Voltage and current monitoring
- Can be controlled by external voltage for CC, Linear CC, CR, CV, CP operating modes
- Protection against V, I, W, and °C
- Optional interface : GPIB · RS232 · USB · LAN
- The most complete measurement capabilities

AEL-5000 Series AC & DC electronic load built-in 16-bit A/D and DSP precision measurement circuit, provides accurate measurements, measurement items have V_{rms} , A_{rms} , Watt, VA, CF, PF, THD, VTHD, ITHD, I_{peak} , A_{max} , A_{min} , V_{max} , and V_{min} In addition to these measurement functions, it also provides time measurement · products such as UPS, fuses and circuit breakers etc. trip or blow time and transfer time for Off-line UPS

AC & DC Electronic Load

POWER CURVE

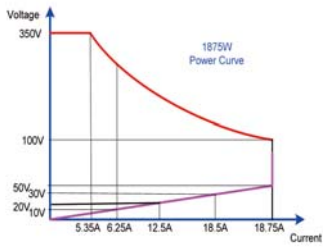

AEL-5002-350-18.75

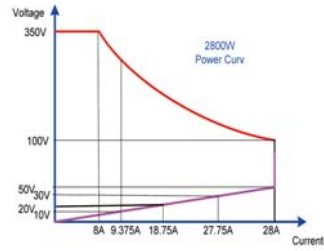

AEL-5003-350-28

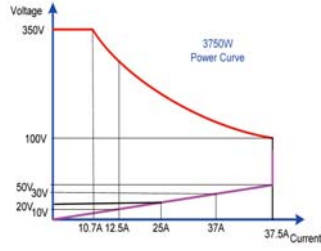

AEL-5004-350-37.5

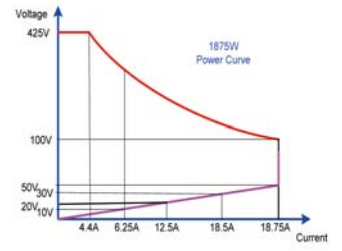

AEL-5002-425-18.75

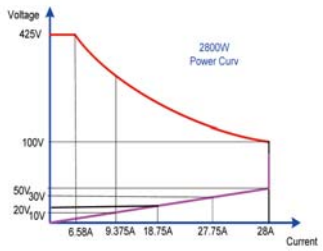

AEL-5003-425-28

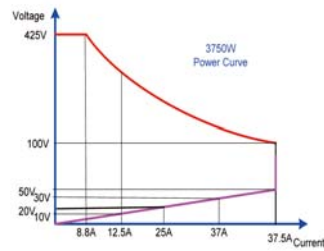

AEL-5004-425-37.5

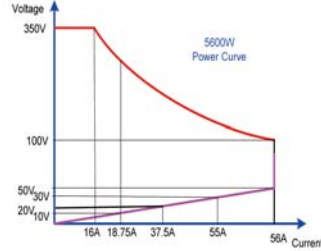

AEL-5006-350-56

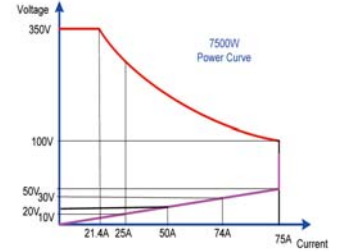

AEL-5008-350-75

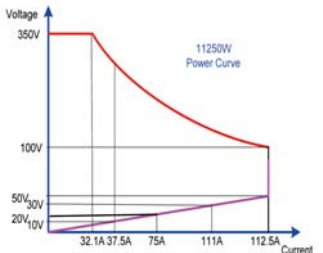

AEL-5012-350-112.5

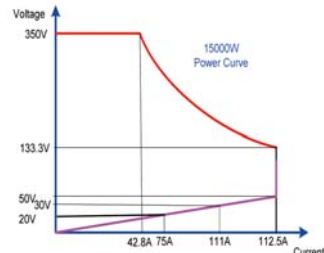

AEL-5015-350-112.5

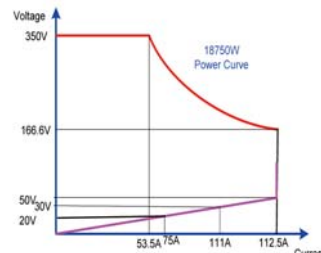

AEL-5019-350-112.5

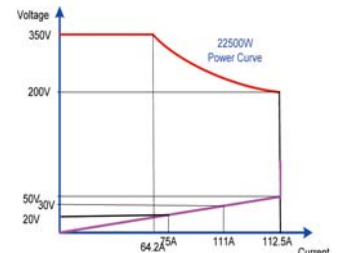

AEL-5023-350-112.5

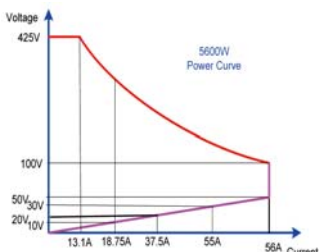

AEL-5006-425-56

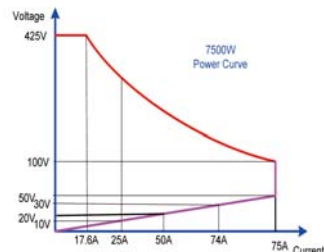

AEL-5008-425-75

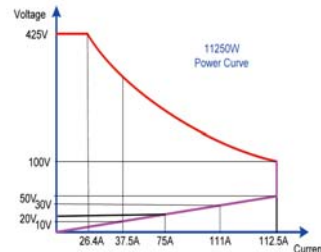

AEL-5012-425-112.5

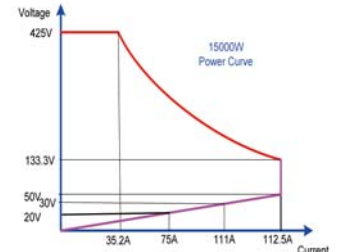

AEL-5015-425-112.5

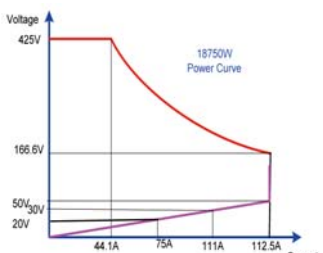

AEL-5019-425-112.5

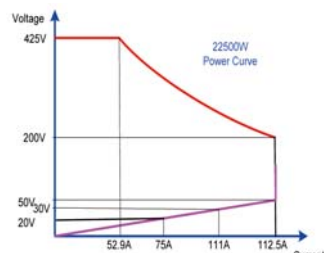

AEL-5023-425-112.5

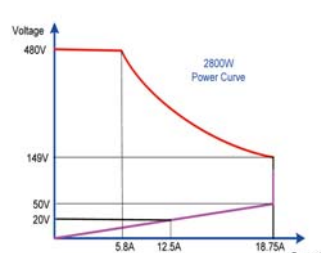

AEL-5003-480-18.75

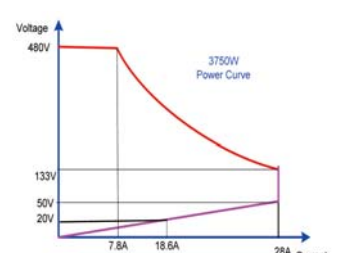

AEL-5004-480-28

AC & DC Electronic Load

COMPLETE AC AND DC LOAD MODES

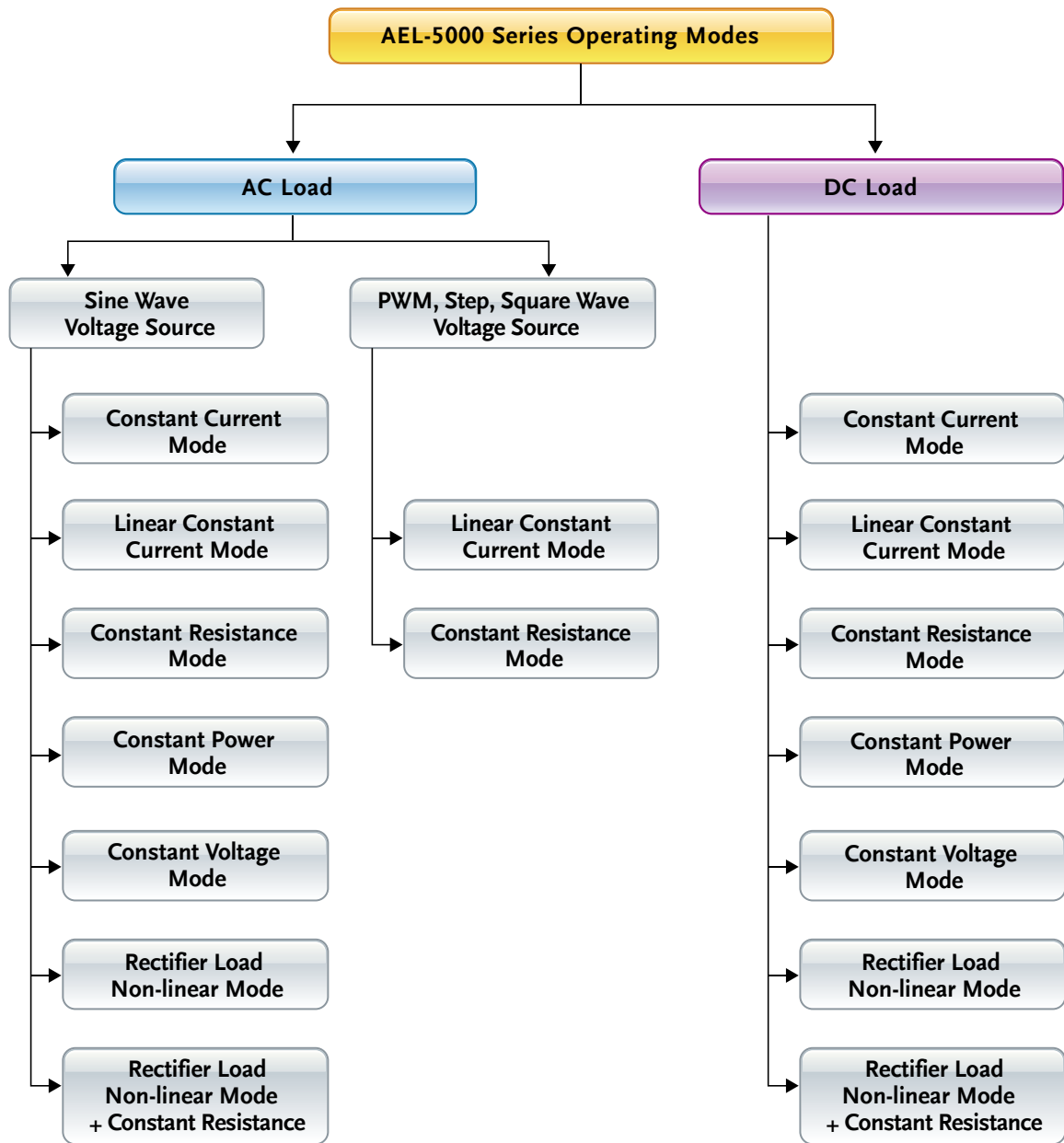

AC LOAD MODE

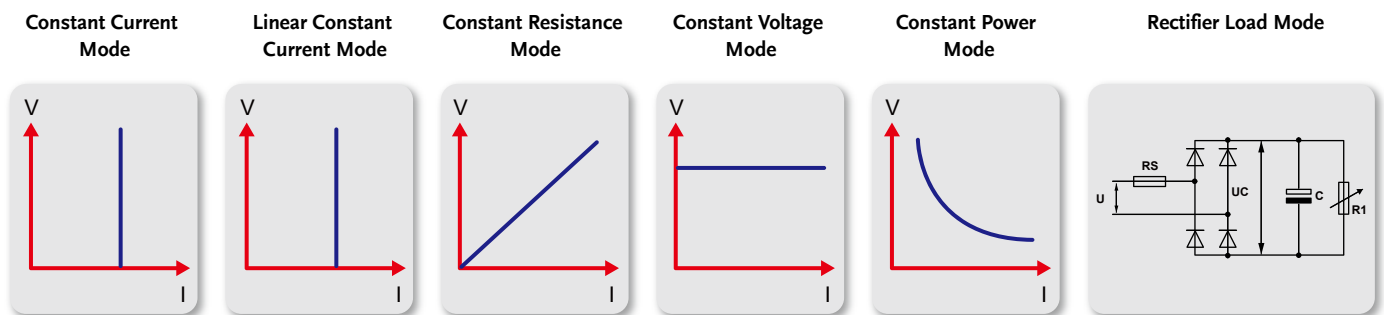

AC & DC Electronic Load

AC LOAD MODE

CC Mode : In the constant current mode of AC Load, can be applied to sine wave voltage source, providing CF, PF test of linear load.

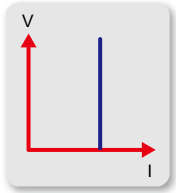

CC mode

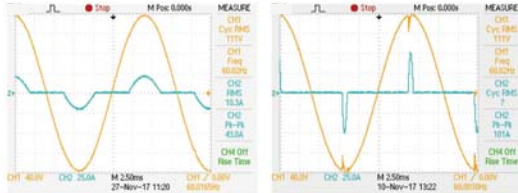

CC mode, CF = 2

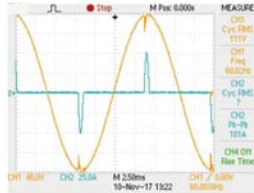

CC mode, CF = 5

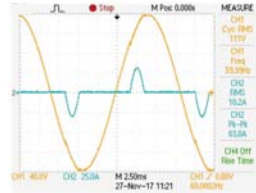

CC mode, CF = +0.5

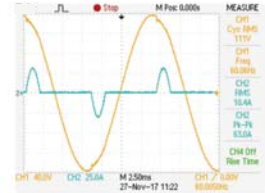

CC mode, CF = -0.5

Linear Constant Current Mode : Can be applied to sine wave and non-sine wave voltage source, as shown in the PWM inverter driver, step voltage source, and off-line UPS sine wave switch to square wave, square wave switch to sine wave.

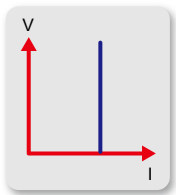

Linear CC mode

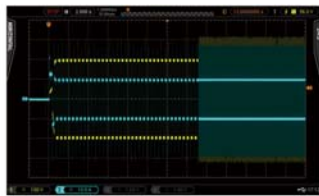

Linear CC mode, PWM 10A 2.5Hz to 250Hz



Linear CC mode, PWM 10A 2.5Hz

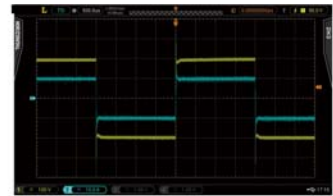

Linear CC mode, PWM 10A 250Hz

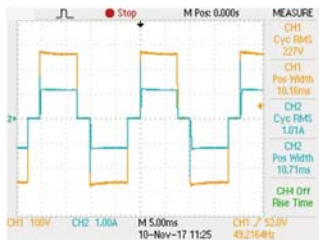

Linear CC mode, Step 10A

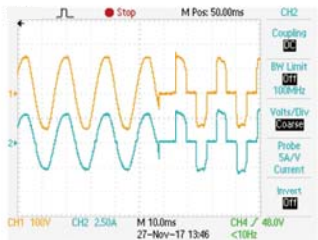

Linear CC mode, UPS Sine to Square Waveform

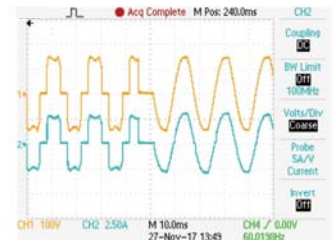

Linear CC mode, UPS Sine to Square Waveform

Supported on-load start-up : at first set Load ON to support on-load start-up, inverter or uninterruptible power supply is start-up directly with the set load current, used to verify whether the Inverter is stable when the load is connected during start-up.

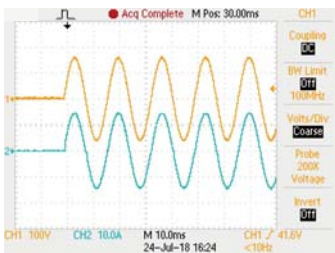

CC 10 A on-load boot

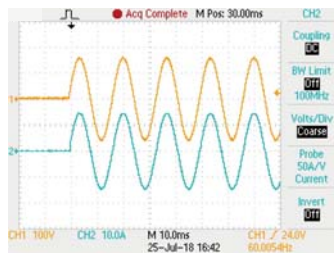

CR 10 A on-load boot

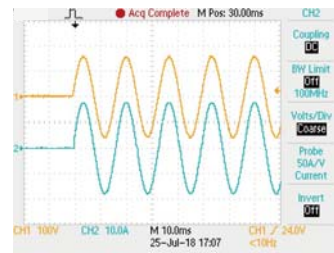

CV 10 A on-load boot

AC & DC Electronic Load

Supports the loading and unloading current angle control ; the loading and unloading current angle range of 0-359 degrees can be programmed to verify whether the Inverter output voltage transient response is stable during the actual electrical appliance is connected or turn ON / OFF randomly it can be used to verify the Overshoot / Undershoot response is within the desire range.

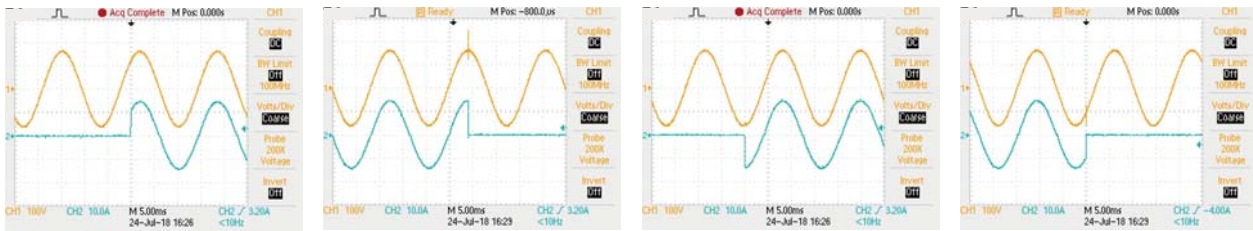

45 degrees loading

90 degrees unloading

270 degrees loading

315 degrees unloading

Support positive half-cycle or negative half-cycle loading ; it can be used to verify whether the Inverter output voltage remains stable when the actual appliance has only positive half-cycle or negative half-cycle load current.

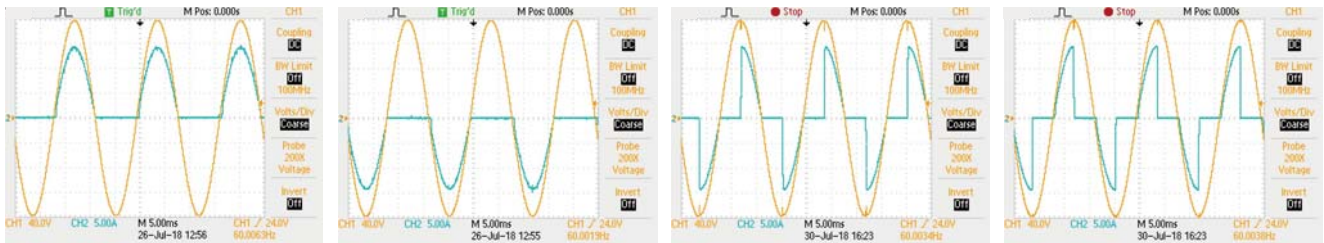

positive half-cycle

negative half-cycle

90 degrees TRIAC/SCR current waveforms Leading edge

90 degrees current waveforms Leading edge

Support the Inrush Current of the inverter at startup and Power Plug-in test when the power supply is turned on to verify the Inrush Current and the sudden connection of the appliance when the power is turned on(Surge Current), to verify if whether the Inverter output voltage transient response is stable, as shown in the figure below.

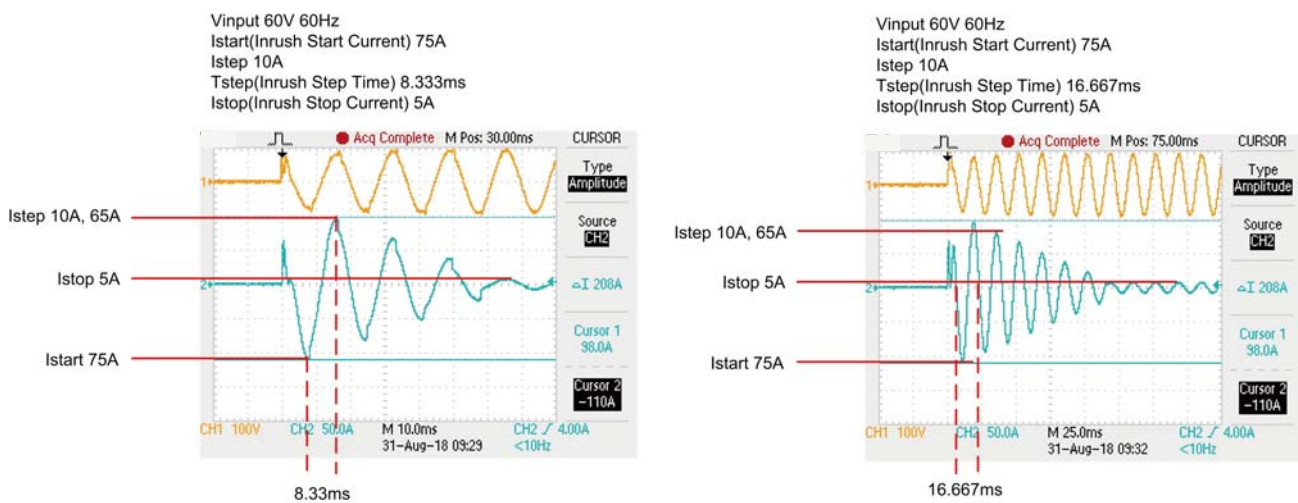

Inrush current test at boot

AC & DC Electronic Load

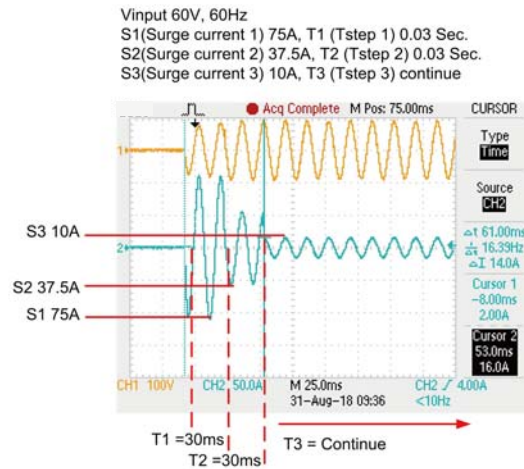
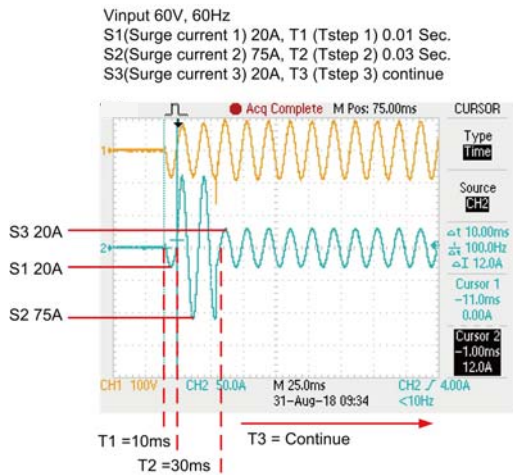

Inrush Current test at boot

AC RECTIFIED LOAD SIMULATION MEET THE IEC62040-3 AND IEC61683 TEST SPECIFICATIONS

AEL-5000 Series AC & DC electronic load AC rectified load mode is fully compliance with the IEC test specification requirements for the UPS, IEC 62040-3 UPS Efficiency Measurement Non-Linear and IEC 61683 Resistive Plus Non-Linear, respectively, AEL-5000 Series AC rectifier load mode uses CC + CR load mode and maintain current THD at 80%, to simulate the actual PV Inverter connected to the electronic device.

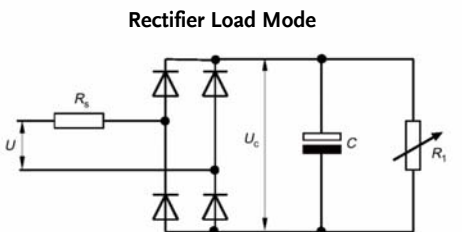

IEC 508/99

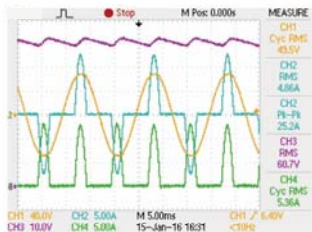

The actual V / A waveform

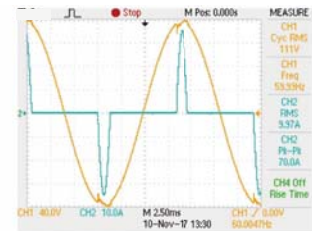
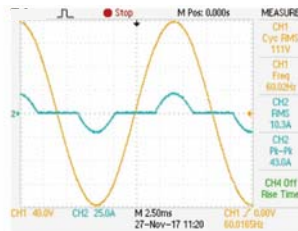

Non-Linear CC mode for UPS test

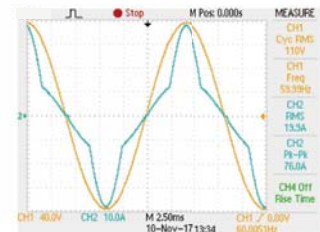
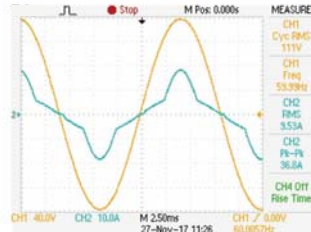

110V, 5A + 22ohm Test Waveform 110V, 10A + 11ohm Test Waveform
 PV Inverter test Non-Linear CC + Resistive mode (CC+CR)

AC & DC Electronic Load

AEL-5000 LOAD VARIOUS TEST MODES

The AEL-5000 Series AC & DC electronic load features built-in test modes for a variety of products. Including AC Load of UPS, Inverter, Fuse/Breaker, AC Power Source, and DC Load of Battery, Fuse/Breaker, DC Power Source etc., as shown below.

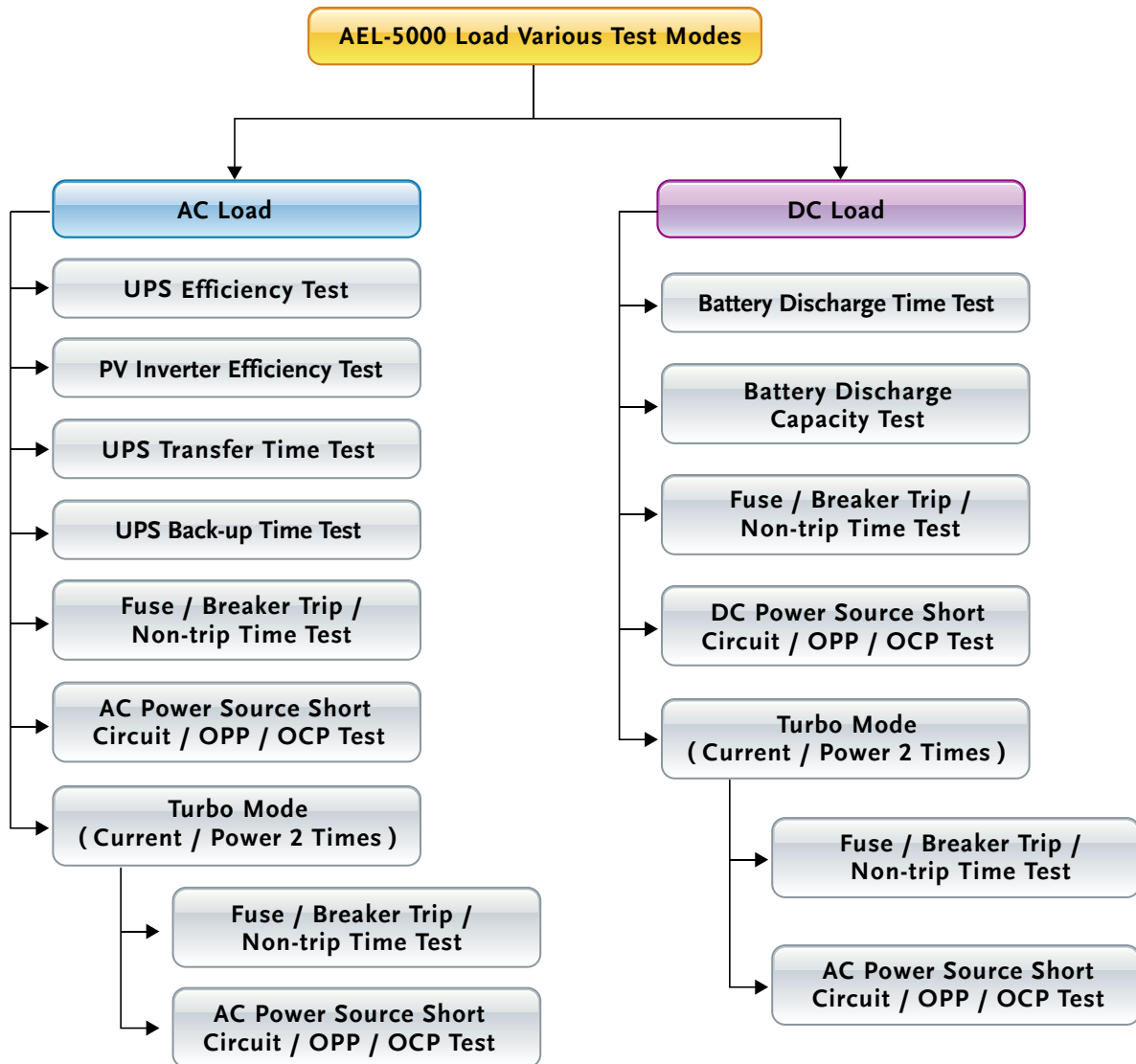

AC & DC Electronic Load

CURRENT PROTECTION COMPONENT TEST

Current protection component includes Fuse, Circuit breakers and a new PTC Resettable fuse etc., its function is when the circuit current exceeds the design of the rated value, that is, if the load exceeds the design of the current capacity, the circuit will be disconnected, in order to avoid overheating, even fire. Fuse is a one-time use of the protection components, Breaker and PTC can be reused.

The current protection components of the protection current value and the protection reaction time has usually a product of the relationship that is, the greater the current through the current protection component, the shorter the reaction time to protect the circuit. This is similar to energy protection components.

Due to this feature, the AEL-5000 Series AC & DC electronic load, in particular for the verification of current protection components, has developed a Fuse Test function to test and verify such protection element with an electronic load of rated current and power. When Turbo mode is set to ON, the test current can be up to double the maximum current within 1 second of test period. Take AEL-5004-350-37.5 as an example, the maximum test current can be doubled to 75A. That is, when the Turbo mode of the AEL-5000 Series is ON, the test current value can reach to 2 units AEL-5000 Series (normal mode) within 1



Turbo OFF, Short 100ms 37.5A
Test result screen

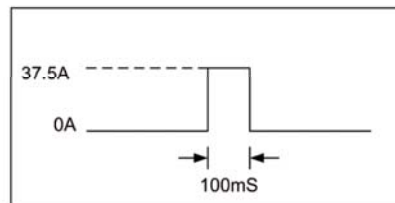

Turbo OFF, Short 100ms 37.5A Setting

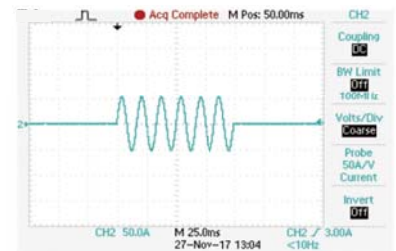

Turbo OFF, Short 100ms 37.5A
The actual test waveform



Turbo ON, Short 100ms 75.0A
Test result screen

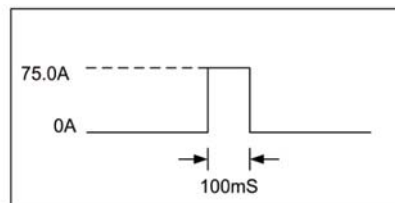

Turbo ON, Short 100ms 75.0A Setting

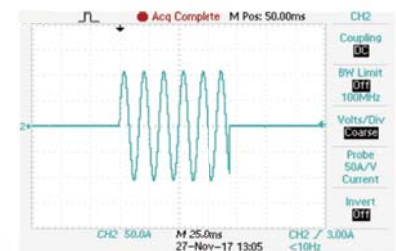

Turbo ON, Short 100ms 75.0A
The actual test waveform

AC & DC Electronic Load



Turbo OFF, OCP Istep 3.75 A Istop 37.5A
Test result screen

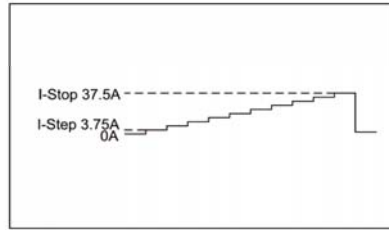

Turbo OFF, OCP Istep 3.75 A Istop 37.5A
Setting

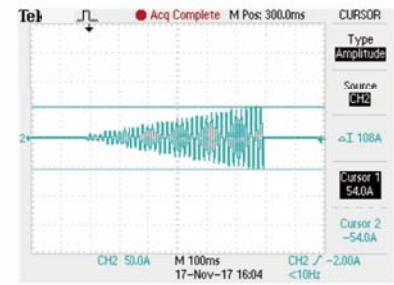

Turbo OFF, OCP Istep 3.75 A Istop 37.5A
The actual test waveform



Turbo ON, OCP Istep 7.5 A Istop 75A
Test result screen

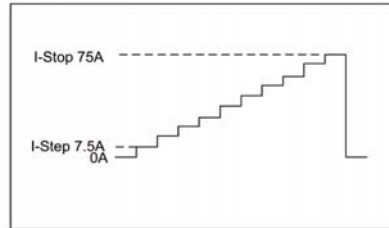

Turbo ON, OCP Istep 7.5 A Istop 75.0A
Setting

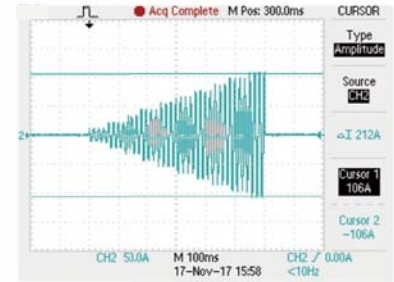

Turbo ON, OCP Istep 7.5 A Istop 75.0A
The actual test waveform

Basically, Fuse test has Trip (Blown) and Non-Trip (no Blown) 2 types.

Fuse Test setting parameters include test current (Istart), test time (Time), test REPEAT Time etc..

In the Trip fuse test, it is used to test when there is too large abnormal current the Fuse or Bleaker must be able to provide the protection of the circuit break, that means current protection components need the fuse action, therefore the test current needs to be larger than the fuse current rating.

When the AEL-5000 Series AC & DC electronic load detects a voltage lower than 1.0V, the LCD displays the number of Repeat Cycle and Current Protection Fusing Time XXXX.X sec.

In the Non-Trip (no Blown) test, the current protection component is required to achieve non-blow action, so the test current needs to be lower than the fuse current rating that is used to verify the fuse must not blow during normal current range. When the AEL-5000 Series AC & DC electronic load is not blown after the test time (Pulse Time) and the repeated Repeat number, the LCD displays the information of the Repeat number.



Turbo : OFF, Fuse mode
Test result screen

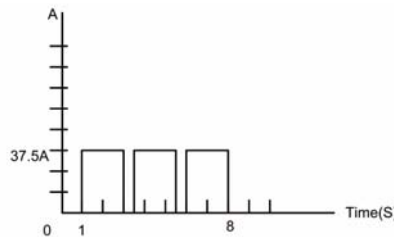

Setting : Turbo : OFF, Fuse ON
CC pulse 37.5A, 2S, Test 3 cycles

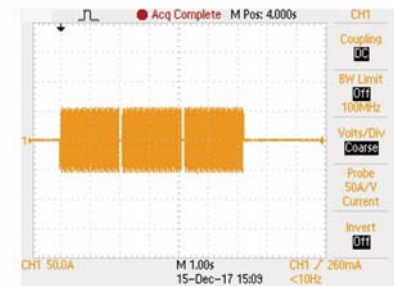

Turbo : OFF, Fuse ON, CC pulse 37.5A, 2S,
Test 3 cycles the actual test waveform



Turbo ON, Fuse mode
Test result screen

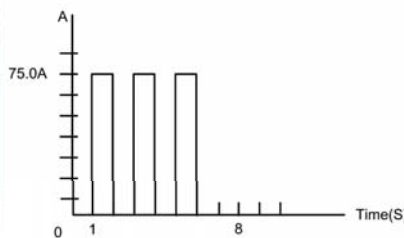

Setting : Turbo : ON, Fuse ON
CC pulse 75.0A, 1S, Test 3 cycles

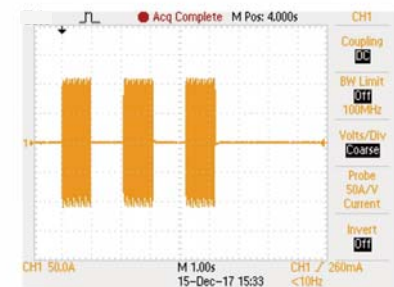

Turbo : ON, Fuse ON, CC pulse 75A, 1S,
Test 3 cycles the actual test waveform

AC & DC Electronic Load

BATTERY TEST FUNCTION

AEL-5000 Series AC & DC electronic load has built-in new TYPE1 ~ TYPE3 battery discharge test, you can select the desired battery test mode, the test results can be directly displayed on the LCD display for battery AH capacity, the voltage value after discharge and the cumulative discharge time.

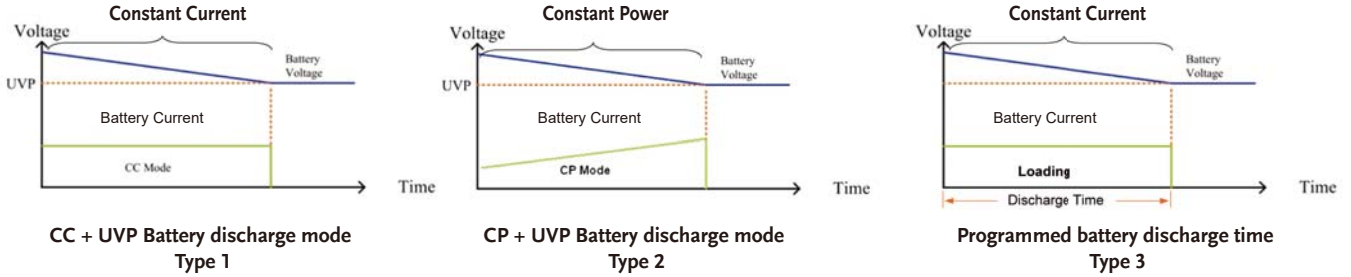

PARALLEL AND THREE-PHASE CONTROL

The AEL-5000 Series AC & DC load provides multiple units in parallel, three-phase applications that allows users to test applications with greater power or three-phase AC power, this is more flexibility to use the AEL-5000 Series AC & DC Electronic Load for control. In parallel / three-phase operation, the user operates the unit as the operation of a single machine, as long as the Master can be operated, Slave1 and Slave2 will automatically sink the load and measurement. Parallel and three-phase connection as shown below.

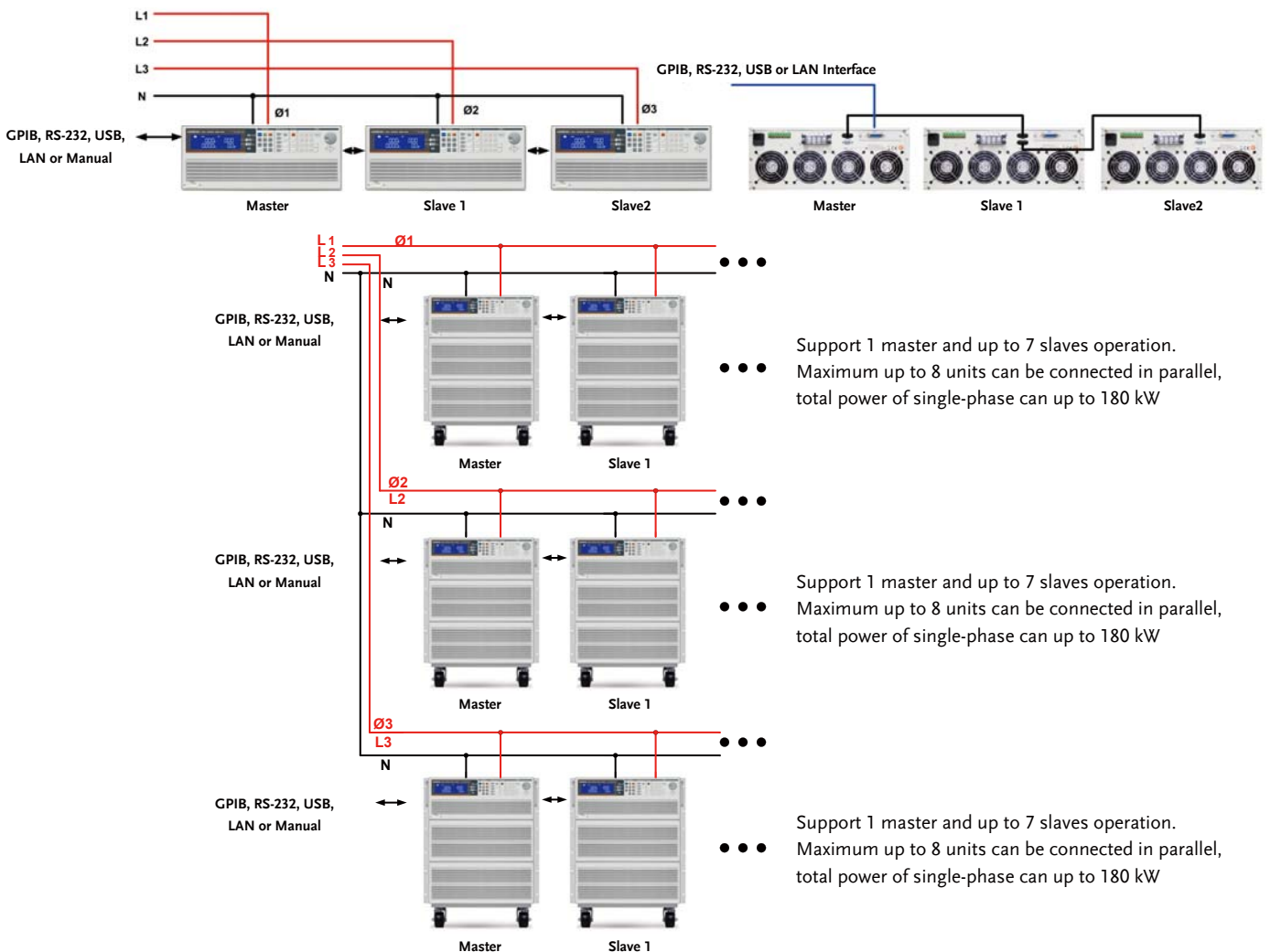

Maximum power of single-phase can up to 180KW, 3-phase total power up to 540KW 3-phase Δ or Y Connection

AC & DC Electronic Load

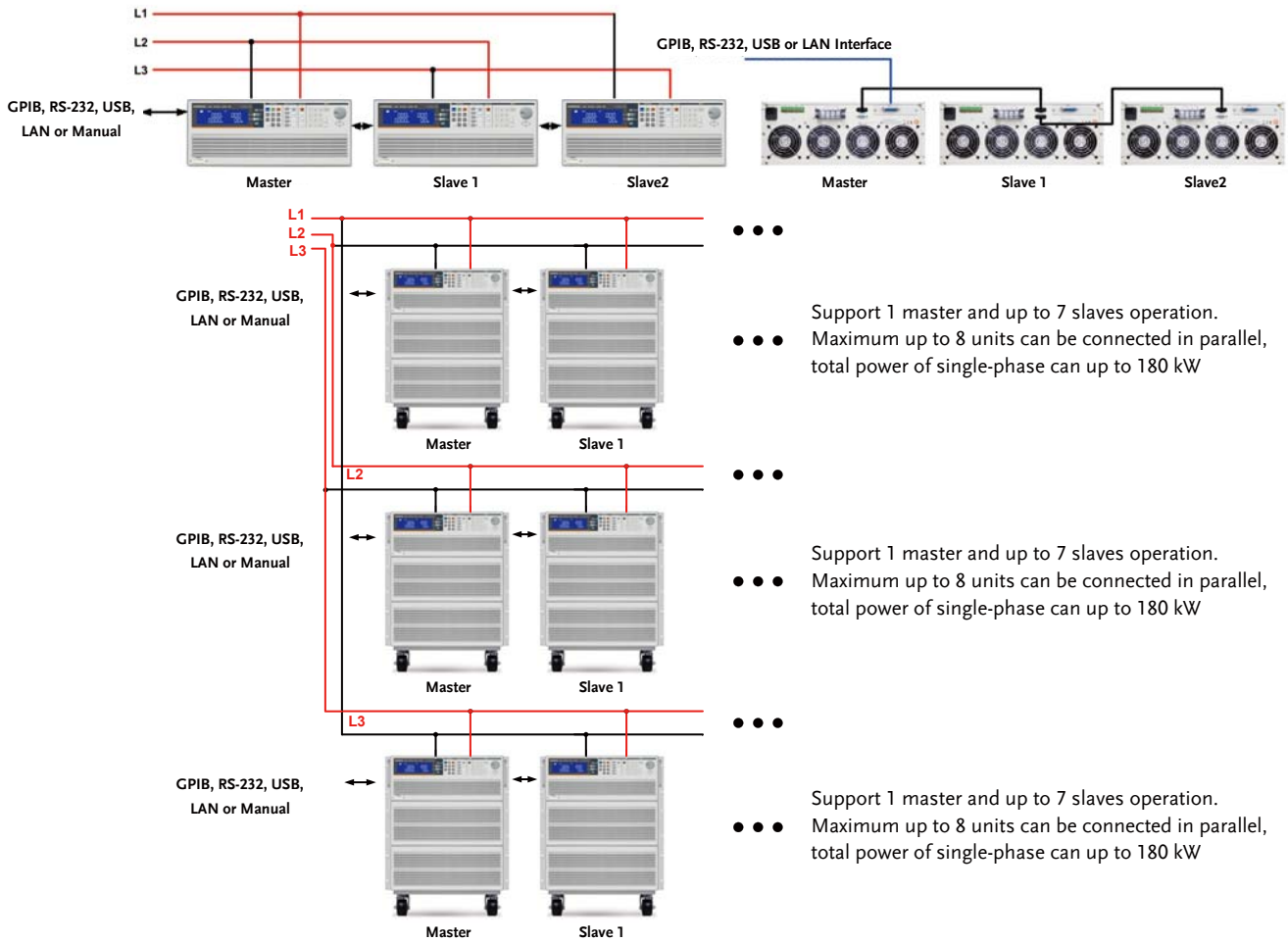

Maximum power of single-phase can up to 180KW, 3-phase total power up to 540KW 3-phase Δ or Y Connection parallel connection

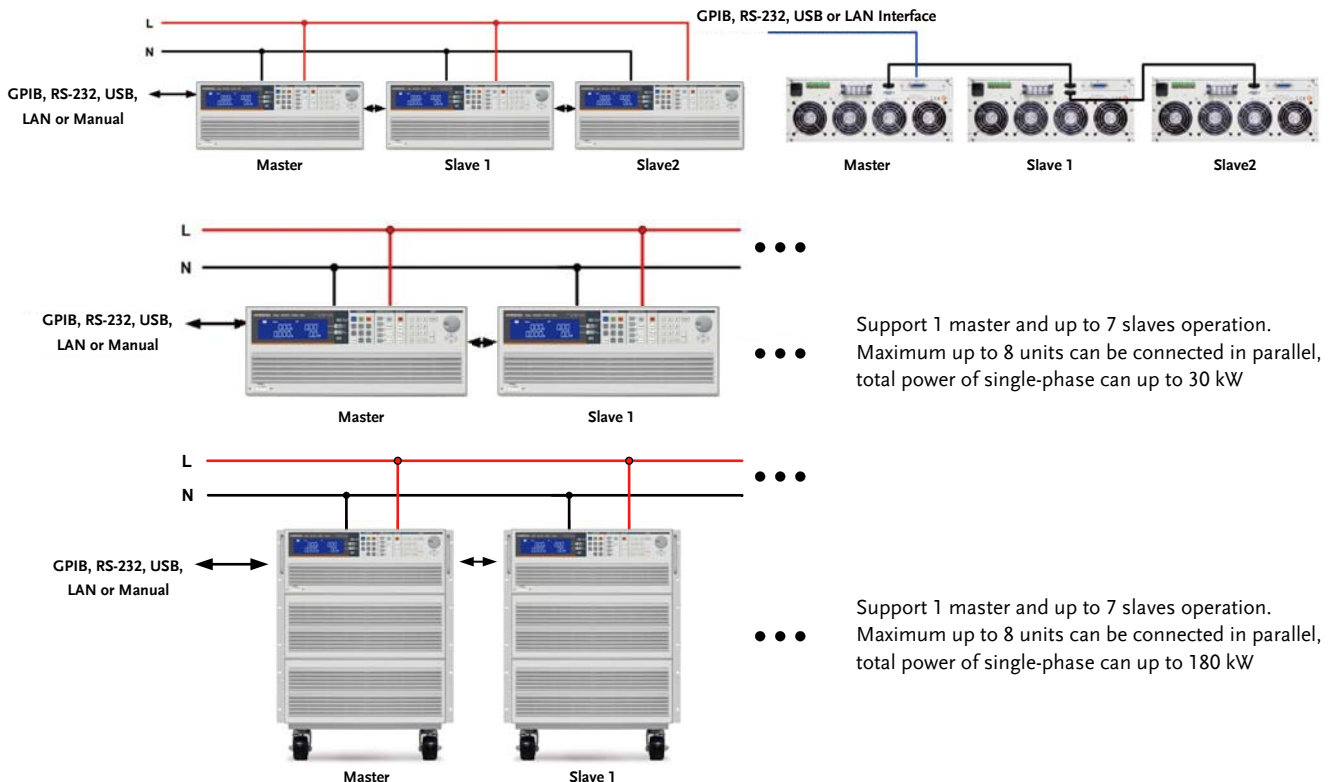

Parallel connection

AC & DC Electronic Load

PANEL INSTRUCTIONS



1	LCD Multi-function display Four meters can display the voltage value at the same time the Voltage(Vrms, Vpeak, Vmax., Vmin) \ Current (Irms, Ipeak, Imax., Imin.) \ Watt, Voltampere(VA) \ Frequency \ Crest Factor \ Power Factor \ Total Harmonic Distortion of Voltg(VTHD) \ Voltage Harmonic(VH) \ Total Harmonic Distortion of Current(ITHD) \ Current Harmonic(IH)	3	Operate function keys Mode \ Preset ON / OFF \ Load ON / OFF \ Sense ON / OFF \ Level A / B \ Config \ Limit \ Recall \ Store \ SEQ \ Local \ System operate function keys
		4	Waveform library keys Can be quickly set CF $\sqrt{2}$ / 2 / 2.5 / 3 / 3.5 , +/- PF0.6 / 0.7 / 0.8 / 0.9 / 1.0 , FREQ Auto / 50Hz/ 60Hz / 400Hz °
		5	Test function keys Can select Short / OPP / OCP / Non-L / NL-CR / Fuse / Batt (Battery Discharge) / Trans (UPS transfer time) test functions.
2	Meter switch button V / A / W keys can set the display Rms / Peak / Max / Min, Meter key can select PF / CF / FREQ , switchable display WATT / VA / VAR keys , THD key choose to display THD	6	Numeric keypad
		7	Knob setting
		8	Switch
		9	Cursor and button setting

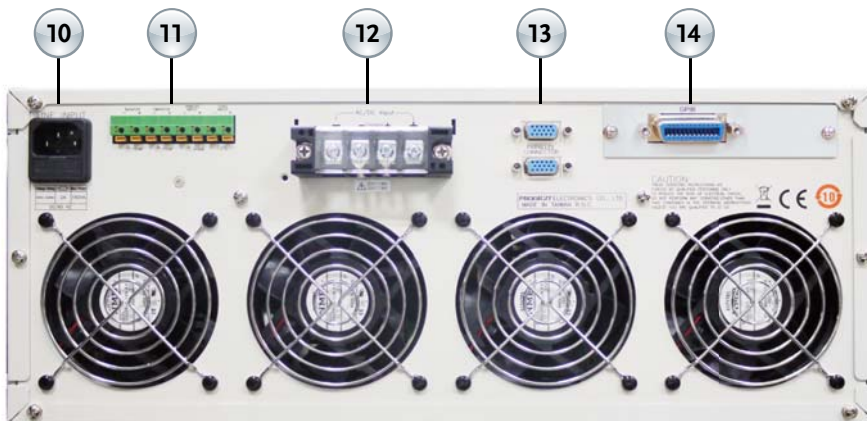

10	AC power input connector	13	Master-slave control connector Master : Connect the top or bottom to the next unit Slave : The top connects to the previous unit and the bottom connects to the next unit
11	Vmonitor \ Imonitor \ Analog input \ SYNC input Input terminal		
12	Vload, Vsense Input terminal	14	Communication interface (GPIB \ RS-232 \ USB \ LAN)

AC & DC Electronic Load

SPECIFICATIONS

MODEL	AEL-5002-350-18.75	AEL-5003-350-28	AEL-5004-350-37.5	AEL-5002-425-18.75	AEL-5003-425-28	AEL-5004-425-37.5
Power (W)	1875 W	2800W	3750 W	1875 W	2800W	3750 W
Current(Ampere)	18.75 Arms / 56.25Apeak	28 Arms / 84Apeak	37.5 Arms / 112.5Apeak	18.75 Arms / 56.25Apeak	28 Arms / 84Apeak	37.5 Arms / 112.5Apeak
Voltage(Volt)	50-350Vrms / 500Vdc			50-425Vrms / 600Vdc		
FREQUENCY Range	DC,40-440Hz(CC,CP Mode), DC-440Hz(LIN,CR,CV Mode)			DC,40-440Hz(CC,CP Mode), DC-440Hz(LIN,CR,CV Mode)		
PROTECTIONS	DC,40-440Hz(CC,CP Mode), DC-440Hz(LIN,CR,CV Mode)			DC,40-440Hz(CC,CP Mode), DC-440Hz(LIN,CR,CV Mode)		
Over Power Protection	≅ 1968.75Wrms or Programmable	≅ 2940Wrms or Programmable	≅ 3937.5Wrms or Programmable	≅ 1968.75Wrms or Programmable	≅ 2940Wrms or Programmable	≅ 3937.5Wrms or Programmable
Over Current Protection	≅ 19.687 Arms or Programmable	≅ 28 Arms or Programmable	≅ 39.375 Arms, or Programmable	≅ 19.687 Arms or Programmable	≅ 28 Arms or Programmable	≅ 39.375 Arms, or Programmable
Over Voltage Protection		≅ 367.5 Vrms / 525Vdc			≅ 446.25 Vrms/630Vdc	
Over Temp. Protection		Yes			Yes	
OPERATION MODE						
Constant Current Mode for Sine-Wave						
Range	0-18.75A	0-28A	0-37.5A	0-18.75A	0-28A	0-37.5A
Resolution	0.3125mA/16bits	0.5mA/16bits	0.625mA/16bits	0.3125mA/16bits	0.5mA/16bits	0.625mA/16bits
Accuracy	± (0.1% of setting + 0.2% of range) @ 50/60Hz					
Linear Constant Current Mode for Sine-Wave, Square Wave or Quasi-Square Wave, PWM Wave						
Range	0-18.75A	0-28A	0-37.5A	0-18.75A	0-28A	0-37.5A
Resolution	0.3125mA/16bits	0.5mA/16bits	0.625mA/16bits	0.3125mA/16bits	0.5mA/16bits	0.625mA/16bits
Accuracy	± (0.1% of setting + 0.2% of range) @ 50/60Hz					
Constant Resistance Mode						
Range	3.2 ohm - 64K ohm	2.0 ohm - 40K ohm	1.6 ohm - 32K ohm	3.2 ohm - 64K ohm	2.0 ohm - 40K ohm	1.6 ohm - 32K ohm
Resolution ¹	0.0052083mS/16bits	0.0083333mS/16bits	0.010416mS/16bits	0.0052083mS/16bits	0.0083333mS/16bits	0.010416mS/16bits
Accuracy	±0.2% of (setting + range) @ 50/60Hz					
Constant Voltage Mode						
Range	50-350Vrms / 500Vdc			50-425Vrms / 600Vdc		
Resolution	0.01V			0.1V		
Accuracy	±(0.1% of setting + 0.1% of range)			±(0.1% of setting + 0.1% of range)		
Constant Power Mode						
Range	1875W	2800W	3750W	1875W	2800W	3750W
Resolution	0.1W	0.1W	0.1W	0.1W	0.1W	0.1W
Accuracy	±(0.1% of setting + 0.1% of range)					
CREST FACTOR (CC & CP MODE ONLY)						
Range	√2-5			√2-5		
Resolution	0.1			0.1		
Accuracy	(0.5% / Irms) + 1% F.S.			(0.5% / Irms) + 1% F.S.		
POWER FACTOR (CC & CP MODE ONLY)						
Range	0-1 Lag or Lead			0-1 Lag or Lead		
Resolution	0.01			0.01		
Accuracy	1% F.S.			1% F.S.		
TEST MODE						
UPS Efficient Measurement	Non-Linear Mode			Non-Linear Mode		
Operating Frequency	Auto; 40-440Hz			Auto; 40-440Hz		
Current Range	0-18.75A	0-28A	0-37.5A	0-18.75A	0-28A	0-37.5A
PF Range	0-1			0-1		
Measuring Efficiency for PV Systems, Power Conditioners for THD 80%						
Operating Frequency	Resistive + Non-Linear Mode			Resistive + Non-Linear Mode		
Auto; 40-440Hz						
Current Range	0-18.75A	0-28A	0-37.5A	0-18.75A	0-28A	0-37.5A
Resistive Range	3.2 ohm - 64K ohm	2.0 ohm - 40K ohm	1.6 ohm - 32K ohm	3.2 ohm - 64K ohm	2.0 ohm - 40K ohm	1.6 ohm - 32K ohm
UPS Back-Up Function(CC,LIN,CR,CP)						
UVP (VTH)	50-350Vrms / 500Vdc			50-425Vrms / 600Vdc		
UPS Back-Up Time	1-99999 Sec. (>27H)			1-99999 Sec. (>27H)		
Battery Discharge Function(CCLIN,CR,CP)						
UVP (VTH)	50-350Vrms / 500Vdc			50-425Vrms / 600Vdc		
Battery Discharge Time	1-99999 Sec. (>27H)			1-99999 Sec. (>27H)		
UPS Transfer Time						
Current Range	0-18.75A	0-28A	0-37.5A	0-18.75A	0-28A	0-37.5A
UVP (VTH)	2.5V			2.5V		
Time Range	0.15ms-999.99ms			0.15ms-999.99ms		
Fuse Test Mode						
Turbo OFF	18.75Arms			18.75Arms		
Turbo ON	37.5Arms (x2) ³			37.5Arms (x2) ³		
Trip & Non-Trip Time	Turbo OFF			Turbo OFF		
Turbo ON	56.0Arms (x2) ³			56.0Arms (x2) ³		
Meas. Accuracy	0.1-9999.9Sec.			0.1-9999.9Sec.		
Repeat Cycle	±0.003 Sec.			±0.003 Sec.		
Short/OPP/OCF Test Function						
Turbo OFF	0.1-10Sec. or Cont.			0.1-10Sec. or Cont.		
Turbo ON	0.1-15Sec.			0.1-15Sec.		
OPP/OCF Step Time	100ms			100ms		
Turbo ON	100ms, up to 10 Steps			100ms, up to 10 Steps		
OCF Istop	Turbo OFF			Turbo OFF		
Turbo ON	18.75Arms			18.75Arms		
OPP Pstop	Turbo OFF			Turbo OFF		
Turbo ON	37.5Arms			37.5Arms		
Programmable Inrush Current Simulation: Istart - Istop / Tsep						
Istart, Inrush Start Current	0-37.5A	0-56A	0-75A	0-37.5A	0-56A	0-75A
Inrush Stop Time	0.1ms-100ms			0.1ms-100ms		
Inrush, Inrush Stop Current	0-18.75A	0-28A	0-37.5A	0-18.75A	0-28A	0-37.5A
Programmable Surge Current Simulation: S1/T1 - S2/T2 - S3/T3						
S1 and S2 Current	0-37.5A	0-56A	0-75A	0-37.5A	0-56A	0-75A
T1 and T2 Time	0.01-0.55Sec.			0.01-0.55Sec.		
S3 Current	0-18.75A	0-28A	0-37.5A	0-18.75A	0-28A	0-37.5A
T3 Time	0.01-9.99Sec. or Cont.			0.01-9.99Sec. or Cont.		
MEASUREMENTS						
VOLTAGE READBACK V METER						
Range	500V			600V		
Resolution	0.01V			0.01V		
Accuracy	±0.05% of (reading + range)			±0.05% of (reading + range)		
Parameter	Vrms,V Max/Min,+/-Vpk			Vrms,V Max/Min,+/-Vpk		
CURRENT READBACK A METER						
Range	9.375Arms/18.75Arms	14Arms/28Arms	18.75Arms/37.5Arms	9.375Arms/18.75Arms	14Arms/28Arms	18.75Arms/37.5Arms
Resolution	0.2mA/0.4mA	0.3mA/0.6mA	0.4mA/0.8mA	0.2mA/0.4mA	0.3mA/0.6mA	0.4mA/0.8mA
Accuracy	±0.05% of (reading + range) @ 50/60Hz					
Parameter	Irms,I Max/Min,+/-Ipk			Irms,I Max/Min,+/-Ipk		
WATT READBACK W METER						
Range	1875W	2800W	3750W	1875W	2800W	3750W
Resolution	0.03125W	0.05W	0.0625W	0.03125W	0.05W	0.0625W
Accuracy	±0.1% of (reading + range)			±0.1% of (reading + range)		
VA METER						
Parameter	VrmsxArms Correspond To Vrms and Arms			VrmsxArms Correspond To Vrms and Arms		
POWER FACTOR METER						
Range	+/- 0.000-1.000			+/- 0.000-1.000		
Accuracy	±(0.002±(0.001/PPF)*F)			±(0.002±(0.001/PPF)*F)		
FREQUENCY METER(V)						
Range	DC,40-440Hz			DC,40-440Hz		
Accuracy	0.1%			0.1%		
Other Parameter METER	VA, VAR, CF, I, Ipeak, Imax, Imin, Vmax, Vmin, IHD, VHD, ITHD, VTHD					
OTHERS						
Start up Loading	Yes, Power on loading during Inverter / UPS start up			Yes, Power on loading during Inverter / UPS start up		
Load ON / OFF Angle	0 - 359 degree can be programmed for the angle of load ON and load OFF loading			0 - 359 degree can be programmed for the angle of load ON and load OFF loading		
Half Cycle and SCR/TRIAC Loading	Positive or Negative half cycle, 90 Trailing edge or Leading edge current waveform can be programmed			Positive or Negative half cycle, 90 Trailing edge or Leading edge current waveform can be programmed		
Master/Slave (3 Phase or Parallel Application)	Yes, 1 master and upto 7 slave units			Yes, 1 master and upto 7 slave units		
External Programming Input (OPTION)	F.S / 10Vdc, Resolution 0.1V			F.S / 10Vdc, Resolution 0.1V		
External SYNC Input	TTL			TTL		
Vmonitor (Isolated)	±500V ±10V			±600V ±10V		
Imonitor (Isolated)	±56.25Apk / ±10Vpk	±84Apk / ±10Vpk	±112.5Apk / ±10Vpk	±56.25Apk / ±10Vpk	±84Apk / ±10Vpk	±112.5Apk / ±10Vpk
Interface (OPTION)	GPIB ; RS-232 ; LAN ; USB			GPIB ; RS-232 ; LAN ; USB		
MAX. Power Consumption	150VA			150VA		
Operating Temperature ²	0 - 40 °C					
Current of Input Impedance(mA)@50/60Hz ; @ 400Hz	-V ⁰ 0.3 ; -V ⁰ 2.2	-V ⁰ 0.45 ; -V ⁰ 3.3	-V ⁰ 0.6 ; -V ⁰ 4.4	-V ⁰ 0.3 ; -V ⁰ 2.2	-V ⁰ 0.45 ; -V ⁰ 3.3	-V ⁰ 0.6 ; -V ⁰ 4.4
Dimensions(H x W x D)	177 x 440 x 558 mm	177 x 440 x 558mm	177 x 440 x 558 mm	177 x 440 x 558 mm	177 x 440 x 558mm	177 x 440 x 558 mm
Weight	21.5Kg	27.5Kg	33.5Kg	21.5Kg	27.5Kg	33.5Kg

*1 ms (millisiemens) is the unit of conductance(G), one siemens equal to 1/Ω
 *2 Operating temperature range is 0-40°C, all specification apply for 25°C±5°C, Except as noted
 *3 Turbo mode for up to 2X Current rating & Power rating support Fuse, Short/OCF/OPP test function

* All specifications apply for 50/60Hz
 * All specifications subject to change without notice
 * Input AC Power : 100-240 Vac ±10%, 50/60Hz, Single-phase

AC & DC Electronic Load

SPECIFICATIONS

MODEL	AEL-5006-350-56	AEL-5008-350-75	AEL-5012-350-112.5	AEL-5015-350-112.5	AEL-5019-350-112.5	AEL-5023-350-112.5
Power (W)	5600 W	7500 W	11250 W	15000 W	18750 W	22500 W
Current(Ampere)	56 Arms / 168Apeak	75 Arms / 225Apeak	112.5 Arms / 337.5Apeak	112.5 Arms / 337.5Apeak	112.5 Arms / 337.5Apeak	112.5 Arms / 337.5Apeak
Voltage(Volt)	50-350Vrms / 500Vdc					
FREQUENCY Range	DC, 40-440Hz(CC, CP Mode), DC-440Hz(LIN, CR, CV Mode)					
PROTECTIONS						
Over Power Protection	≠ 5880Wrms or Programmable	≠ 7875Wrms or Programmable	≠ 11812.5Wrms or Programmable	≠ 11812.5Wrms or Programmable	≠ 19687.5Wrms or Programmable	≠ 23625Wrms or Programmable
Over Current Protection	≠ 58.8 Arms, or Programmable	≠ 78.75 Arms, or Programmable	≠ 118.125 Arms or Programmable	≠ 118.125 Arms or Programmable	≠ 118.125 Arms or Programmable	≠ 118.125 Arms or Programmable
Over Voltage Protection	≠ 367.5 Vrms/525Vdc					
Over Temp. Protection	Yes					
OPERATION MODE						
Constant Current Mode for Sine-Wave						
Range	0-56A	0-75A	0-112.5A	0-112.5A	0-112.5A	0-112.5A
Resolution	1mA/16bits	1.25mA/16bits	1.875mA/16bits	1.875mA/16bits	1.875mA/16bits	1.875mA/16bits
Accuracy	± (0.1% of setting + 0.2% of range) @ 50/60Hz					
Linear Constant Current Mode for Sine-Wave, Square-Wave or Quasi-Square Wave, PWM Wave						
Range	0-56A	0-75A	0-112.5A	0-112.5A	0-112.5A	0-112.5A
Resolution	1mA/16bits	1.25mA/16bits	1.875mA/16bits	1.875mA/16bits	1.875mA/16bits	1.875mA/16bits
Accuracy	± (0.1% of setting + 0.2% of range) @ 50/60Hz					
Constant Resistance Mode						
Range	1 ohm - 20K ohm	0.8 ohm - 16K ohm	0.533 ohm - 10.666K ohm	0.533 ohm - 10.666K ohm	0.533 ohm - 10.666K ohm	0.533 ohm - 10.666K ohm
Resolution*1	0.016666mS/16bits	0.020832mS/16bits	0.031248mS/16bits	0.031248mS/16bits	0.031248mS/16bits	0.031248mS/16bits
Accuracy	±0.2% of (setting + range) @ 50/60Hz					
Constant Voltage Mode						
Range	50-350Vrms / 500Vdc					
Resolution	0.1V					
Accuracy	±0.2% of (setting + range) @ 50/60Hz					
Constant Power Mode						
Range	5600W	7500W	11250W	15000 W	18750W	22500W
Resolution	0.1W	0.1W	1W	1W	1W	1W
Accuracy	±0.2% of (setting + range) @ 50/60Hz					
CREST FACTOR (CC & CP MODE ONLY)						
Range	√2-5					
Resolution	0.1					
Accuracy	(0.5% / Irms) + 1% F.S.					
POWER FACTOR (CC & CP MODE ONLY)						
Range	0-1 Lag or Lead					
Resolution	0.01					
Accuracy	1% F.S.					
TEST MODE						
UPS Efficient Measurement						
Operating Frequency	Non-Linear Mode					
Current Range	0-56A	0-75A	0-112.5A	0-112.5A	0-112.5A	0-112.5A
PF Range	Auto ; 40-440Hz					
Measuring Efficiency for PV Systems, Power Conditioners for THD 80%						
Operating Frequency	Resistive + Non-Linear Mode					
Current Range	0-56A	0-75A	0-112.5A	0-112.5A	0-112.5A	0-112.5A
Resistive Range	1 ohm - 20K ohm	0.8 ohm - 16K ohm	0.533 ohm - 10.666K ohm	0.533 ohm - 10.666K ohm	0.533 ohm - 10.666K ohm	0.533 ohm - 10.666K ohm
UPS Back-Up Function(CC,LIN,CR,CP)						
UVP (VTH)	50-350Vrms / 500Vdc					
UPS Back-Up Time	1-99999 Sec. (>27H)					
Battery Discharge Function(CC,LIN,CR,CP)						
UVP (VTH)	50-350Vrms / 500Vdc					
Battery Discharge Time	1-99999 Sec. (>27H)					
UPS Transfer Time						
Current Range	0-56A	0-75A	0-112.5A	0-112.5A	0-112.5A	0-112.5A
UVP (VTH)	2.5V					
Time range	0.15ms-999.99ms					
Fuse Test Mode						
Max. Current	Turbo OFF 75Arms 150Arms (x2) ^{*)}	Turbo OFF 75Arms 150Arms (x2) ^{*)}	Turbo OFF 112.5Arms 225Arms (x2) ^{*)}	Turbo OFF 112.5Arms 225Arms (x2) ^{*)}	Turbo OFF 112.5Arms 225Arms (x2) ^{*)}	Turbo OFF 112.5Arms 225Arms (x2) ^{*)}
Trip & Non-Trip Time	Turbo OFF 0.1-9999.9Sec. Turbo ON 0.1-1.0Sec.					
Meas. Accuracy	±0.003 Sec.					
Repeat Cycle	0-255					
Short/OPP/OCF Test Function						
Short Time	Turbo OFF 0.1-10Sec. or Cont.					
OPP/OCF Step Time	Turbo OFF 0.1-15Sec. Turbo ON 100ms, up to 10 Steps					
OCF Istop	Turbo OFF 56Arms	Turbo OFF 75Arms	Turbo OFF 112.5Arms	Turbo OFF 112.5Arms	Turbo OFF 112.5Arms	Turbo OFF 112.5Arms
OCF Pstop	Turbo ON 112Arms 5600W 11200W	Turbo ON 150Arms 7500W 15000W	Turbo ON 225Arms 11250W 22500W	Turbo ON 225Arms 15000W 30000W	Turbo ON 225Arms 18750W 37500W	Turbo ON 225Arms 22500W 45000W
Programmable Inrush Current Simulation: Istart - Istop / Tsep						
Istart, Inrush Start Current	0-112A	0-150A	0-225A	0-225A	0-225A	0-225A
Inrush Stop Time	0.1-15Sec.					
Istop, Inrush Stop Current	0-56A	0-75A	0-112.5A	0-112.5A	0-112.5A	0-112.5A
Programmable Surge Current Simulation: S1/T1 - S2/T2 - S3/T3						
S1 and S2 Current	0-112A	0-150A	0-225A	0-225A	0-225A	0-225A
T1 and T2 Time	0.01-0.5Sec.					
S3 Current	0-56A	0-75A	0-112.5A	0-112.5A	0-112.5A	0-112.5A
T3 Time	0.01-9.99Sec. or Cont.					
MEASUREMENTS						
VOLTAGE READBACK A METER						
Range	500V					
Resolution	0.01V					
Accuracy	±0.05% of (reading + range)					
Parameter	Vrms, V Max/Min, +/-Vpk					
CURRENT READBACK A METER						
Range	28Arms/56Arms	37.5Arms/75Arms	56.25Arms/112.5Arms	56.25Arms/112.5Arms	56.25Arms/112.5Arms	56.25Arms/112.5Arms
Resolution	0.6mA/1.2mA	0.8mA/1.6mA	1.2mA/2.4mA	1.2mA/2.4mA	1.2mA/2.4mA	1.2mA/2.4mA
Accuracy	±0.1% of (reading + range) @ 50/60Hz					
Parameter	Irms, I Max/Min, +/-Ipk					
WATT READBACK W METER						
Range	5600W	7500W	11250W	15000W	18750W	22500W
Resolution	0.1W	0.125W	0.1875W	0.25W	0.3125W	0.375W
Accuracy	±0.2% of (reading + range) @ 50/60Hz ; ±0.4% of (reading + range)					
VA METER						
Power Factor METER	VrmsxArms Correspond To Vrms and Arms					
Range	+/- 0.000-1.000					
Accuracy	±(0.002±(0.001/PPF)*PF)					
FREQUENCY METER(V)						
Range	DC, 40-440Hz					
Accuracy	0.1%					
OTHERS						
Start up Loading	Yes, Power on loading during inverter / UPS start up					
Load ON / OFF Angle	0-359 degree can be programmed for the angle of load ON and load OFF loading					
Half Cycle and SCR/TRIAC Loading	Positive or Negative half cycle, 90 Trailing edge or Leading edge current waveform can be programmed					
Master/Slave (3 Phase or Parallel Application)	Yes, 1 master and upto 7 slave unit					
External Programming Input (OPTION)	F.S / 10Vdc, Resolution 0.1V					
External SYNC Input	TTL					
Vmonitor (Isolated)	±500V ±10V					
Imonitor (Isolated)	±168Apk / ±10Vpk	±225Apk / ±10Vpk	±337.5Apk / ±10Vpk	±337.5Apk / ±10Vpk	±337.5Apk / ±10Vpk	±337.5Apk / ±10Vpk
Interface (OPTION)	GPIB ; RS-232 ; LAN ; USB					
MAX. Power Consumption	270VA	270VA	390VA	510VA	630VA	750VA
Operation Temperature *2						
Current of Input Impedance(mA)@50/60Hz ; @ 400Hz	-V*0.9 ; -V*6.6	-V*1.2 ; -V*8.8	-V*1.8 ; -V*13.2	-V*2.4 ; -V*17.6	-V*3.0 ; -V*22	-V*3.6 ; -V*26.4
Dimension(H x W x D)	458 x 480 x 590 mm	458 x 480 x 590 mm	636 x 480 x 590 mm	814 x 480 x 590 mm	1283 x 600 x 600 mm	1283 x 600 x 600 mm
Weight	58 kg	70 kg	105kg	140kg	260kg	295kg

*1 ms (millisiemens) is the unit of conductance(G), one siemens equal to 1/Ω

*2 Operating temperature range is 0-40°C, all specification apply for 25°C±5°C, Except as noted

*3 Turbo mode for up to 2X Current rating & Power rating support Fuse, Short/OCF/OPP test function

* All specifications apply for 50/60Hz

* All specifications subject to change without notice

* Input AC Power : 100-240 Vac ±10%, 50/60Hz, Single-phase

AC & DC Electronic Load

SPECIFICATIONS

MODEL	AEL-5006-425-56	AEL-5008-425-75	AEL-5012-425-112.5	AEL-5015-425-112.5	AEL-5019-425-112.5	AEL-5023-425-112.5
Power (W)	5600 W	7500 W	11250W	15000 W	18750W	22500W
Current(Ampere)	56 Arms / 168Apeak	75 Arms / 225Apeak	112.5 Arms / 337.5Apeak	112.5 Arms / 337.5Apeak	112.5 Arms / 337.5Apeak	112.5 Arms / 337.5Apeak
Voltage(Volt)	50-425Vrms / 600Vdc					
FREQUENCY Range	DC,40-440Hz(CC,CP Mode), DC-440Hz(LIN,CR,CV Mode)					
PROTECTIONS	Over Power Protection \approx 5880Wrms or Programmable \approx 7875Wrms or Programmable \approx 11812.5Wrms or Programmable \approx 15750Wrms or Programmable \approx 19687.5Wrms or Programmable \approx 23625Wrms or Programmable Over Current Protection \approx 58.8 Arms, or Programmable \approx 78.75 Arms, or Programmable \approx 118.125 Arms or Programmable \approx 118.125 Arms or Programmable \approx 118.125 Arms or Programmable \approx 118.125 Arms or Programmable Over Voltage Protection \approx 446.25 Vrms/630Vdc Over Temp. Protection Yes					
OPERATION MODE	Constant Current Mode for Sine-Wave Range 0-56A 0-75A 0-112.5A 0-112.5A 0-112.5A 0-112.5A Resolution 1mA/16bits 1.25mA/16bits 1.875mA/16bits 1.875mA/16bits 1.875mA/16bits 1.875mA/16bits Accuracy \pm (0.1% of setting + 0.2% of range) @ 50/60Hz Linear Constant Current Mode for Sine-Wave, Square-Wave or Quasi-Square Wave, PWM Wave Range 0-56A 0-75A 0-112.5A 0-112.5A 0-112.5A 0-112.5A Resolution 1mA/16bits 1.25mA/16bits 1.875mA/16bits 1.875mA/16bits 1.875mA/16bits 1.875mA/16bits Accuracy \pm (0.1% of setting + 0.2% of range) @ 50/60Hz Constant Resistance Mode Range 1 ohm ~ 20K ohm 0.8 ohm ~ 16K ohm 0.533 ohm ~ 10.666K ohm 0.533 ohm ~ 10.666K ohm 0.533 ohm ~ 10.666K ohm 0.533 ohm ~ 10.666K ohm Resolution*1 0.016666mS/16bits 0.020832mS/16bits 0.031248mS/16bits 0.031248mS/16bits 0.031248mS/16bits 0.031248mS/16bits Accuracy \pm 0.2% of (setting + range) @ 50/60Hz Constant Voltage Mode Range 50-425Vrms / 600Vdc Resolution 0.1V Accuracy \pm 0.2% of (setting + range) @ 50/60Hz Constant Power Mode Range 5600W 7500W 11250W 15000 W 18750W 22500W Resolution 0.1W 0.1W 1W 1W 1W 1W Accuracy \pm 0.2% of (setting + range) @ 50/60Hz					
CREST FACTOR (CC & CP MODE ONLY)	Range -2-5 Resolution 0.1 Accuracy (0.5% / Irms) + 1% F.S.					
POWER FACTOR (CC & CP MODE ONLY)	Range 0-1 Lag or Lead Resolution 0.01 Accuracy 1% F.S.					
TEST MODE	UPS Efficient Measurement Operating Frequency Non-Linear Mode Current Range Auto: 40-440Hz PF Range 0-1 Measuring Efficiency For PV Systems, Power Conditioners for THD 80% Operating Frequency Auto: 40-440Hz Current Range 0-56A 0-75A 0-112.5A 0-112.5A 0-112.5A 0-112.5A Resistive Range 1 ohm ~ 20K ohm 0.8 ohm ~ 16K ohm 0.533 ohm ~ 10.666K ohm 0.533 ohm ~ 10.666K ohm 0.533 ohm ~ 10.666K ohm 0.533 ohm ~ 10.666K ohm					
UPS Back-Up Function(CC,LIN,CR,CP)	LVP (VTH) 50-425Vrms / 600Vdc UPS Back-Up Time 1-99999 Sec. (~27H) Battery Discharge Function(CC,LIN,CR,CP) LVP (VTH) 50-425Vrms / 600Vdc Battery Discharge Time 1-99999 Sec. (~27H) UPS Transfer Time Current Range 0-56A 0-75A 0-112.5A 0-112.5A 0-112.5A 0-112.5A LVP (VTH) 2.5V Time range 0.15ms-999.99ms					
Fuse Test Mode	Turbo OFF 75Arms 75Arms 112.5Arms 112.5Arms 112.5Arms 112.5Arms Turbo ON 150Arms (x2) *3 150Arms (x2) *3 225Arms (x2) *3 225Arms (x2) *3 225Arms (x2) *3 225Arms (x2) *3 Trip & Non-Trip Time Turbo OFF 0.1-9999.9Sec. Turbo ON 0.1-1.05Sec. Meas. Accuracy \pm 0.003 Sec. Repeat Cycle 0-255					
Short/OPP/OCF Test Function	Short Time Turbo OFF 0.1-10Sec. or Cont. Turbo ON 0.1-15Sec. OPP/OCF Step Time Turbo OFF 100ms Turbo ON 100ms, up to 10 Steps OCP Istop Turbo OFF 56Arms 75Arms 112.5Arms 112.5Arms 112.5Arms 112.5Arms Turbo ON 112Arms 150Arms 225Arms 225Arms 225Arms 225Arms OPP Pstop Turbo OFF 5600W 7500W 11250W 15000W 18750W 22500W Turbo ON 11200W 15000W 22500W 30000W 37500W 45000W					
Programmable Inrush Current Simulation: Istart - Istop / Tsep	Istart, Inrush Start Current 0-112A 0-150A 0-225A 0-225A 0-225A 0-225A Inrush Stop Time 0-56A 0-75A 0-112.5A 0-112.5A 0-112.5A 0-112.5A Istop, Inrush Stop Current 0-112A 0-150A 0-225A 0-225A 0-225A 0-225A Programmable Surge Current Simulation: S1/T1 - S2/T2 - S3/T3 S1 and S2 Current 0-112A 0-150A 0-225A 0-225A 0-225A 0-225A T1 and T2 Time 0.01-0.55Sec. S3 Current 0-56A 0-75A 0-112.5A 0-112.5A 0-112.5A 0-112.5A T3 Time 0.01-9.99Sec. or Cont.					
MEASUREMENTS	VOLTAGE READBACK A METER Range 600V Resolution 0.01V Accuracy \pm 0.05% of (reading + range) Parameter Vrms,V Max/Min,+/-Vpk CURRENT READBACK A METER Range 28Arms/56Arms 37.5Arms/75Arms 56.25Arms/112.5Arms 56.25Arms/112.5Arms 56.25Arms/112.5Arms 56.25Arms/112.5Arms Resolution 0.6mA/1.2mA 0.8mA/1.6mA 1.2mA/2.4mA 1.2mA/2.4mA 1.2mA/2.4mA 1.2mA/2.4mA Accuracy \pm 0.1% of (reading + range) @ 50/60Hz Parameter Irms,I Max/Min,+/-Ipk WATT READBACK W METER Range 5600W 7500W 11250W 15000W 18750W 22500W Resolution 0.1W 0.125W 0.1875W 0.25W 0.3125W 0.375W Accuracy \pm 0.2% of (reading + range) @ 50/60Hz , \pm 0.4% of (reading + range) VA METER Power Factor METER VrmsxArms Correspond To Vrms and Arms Range +/- 0.000-1.000 Accuracy \pm (0.002+(0.001/ PF)*F) Frequency METER(V) Range DC,40-440Hz Accuracy 0.1% Other Parameter METER VA, VAR, CF, I, Ipeak, Imax., Imin, Vmax, Vmin., IHD, VHD, ITHD, VTHD					
OTHERS	Start up Loading Yes, Power on loading during Inverter / UPS start up Load ON / OFF Angle 0 ~ 359 degree can be programmed for the angle of load ON and load OFF loading Half Cycle and SCR/TRIAC Loading Positive or Negative half cycle, 90° Trailing edge or Leading edge current waveform can be programmed Master/Slave (3 Phase or Parallel Application) Yes, 1 master and upto 7 slave unit External Programming Input (OPTION) F.S. / 10Vdc, Resolution 0.1V External SYNC Input TT Vmonitor (Isolated) \pm 600V \pm 10V Imonitor (Isolated) \pm 168Apk / \pm 10Vpk \pm 225Apk / \pm 10Vpk \pm 337.5Apk / \pm 10Vpk \pm 337.5Apk / \pm 10Vpk \pm 337.5Apk / \pm 10Vpk \pm 337.5Apk / \pm 10Vpk Interface (OPTION) GPIB ; RS-232 ; LAN ; USB MAX. Power Consumption 270VA 270VA 390VA 510VA 630VA 750VA Operation Temperature *2 0 ~ 40 °C Current of Input Impedance(mA)@50/60Hz; @ 400Hz -V*0.9; -V*6.6 -V*1.2; -V*8.8 -V*1.8; -V*13.2 -V*2.4; -V*17.6 -V*3.0; -V*22 -V*3.6; -V*26.4 Dimension(H x W x D) 458 x 480 x 590 mm 458 x 480 x 590 mm 636 x 480 x 590 mm 814 x 480 x 590 mm 1283 x 600 x 600 mm 1283 x 600 x 600 mm Weight 58 kg 70 kg 105kg 140kg 260kg 295kg					

*1 ms (millisiemens) is the unit of conductance(G), one siemens equal to 1/Ω
 *2 Operating temperature range is 0-40°C, all specification apply for 25°C±5°C, Except as noted
 *3 Turbo mode for up to 2X Current rating & Power rating support Fuse, Short/OCF/OPP test function

All specifications apply for 50/60Hz
 All specifications subject to change without notice
 * Input AC Power : 100-240 Vac \pm 10%, 50/60Hz, Single-phase

AC & DC Electronic Load

SPECIFICATIONS			
MODEL	AEL-5003-480-18.75		AEL-5004-480-28
Power (W)	2800W		3750 W
Current(Ampere)	18.75 Arms / 56.25Apeak		28 Arms / 84Apeak
Voltage(Volt)	50-480Vrms / 700Vdc		
FREQUENCY Range	DC,40-70Hz(CC,CP Mode) , DC-70Hz(LIN,CR,CV Mode)		
PROTECTIONS			
Over Power Protection	≧2940Wrms or Programmable		
Over Current Protection	≧ 19.687 Arms or Programmable		≧ 3927.5Wrms or Programmable
Over Voltage Protection	≧ 504Vrms / 735Vdc		≧ 29.4 Arms or Programmable
Over Temp. Protection	Yes		
OPERATION MODE			
Constant Current Mode for Sine-Wave			
Range	0-18.75A		0-28A
Resolution	0.3125mA/16bits		0.5mA/16bits
Accuracy	± (0.1% of setting + 0.2% of range) @ 50/60Hz		
Linear Constant Current Mode for Sine-Wave, Square-Wave or Quasi-Square Wave, PWM Wave			
Range	0-18.75A		0-28A
Resolution	0.3125mA/16bits		0.5mA/16bits
Accuracy	± (0.1% of setting + 0.2% of range) @ 50/60Hz		
Constant Resistance Mode			
Range	4 ohm - 80K ohm		2.5 ohm - 50K ohm
Resolution*1	0.004166mS/16bits		0.006666mS/16bits
Accuracy	±0.2% of (setting + range) @ 50/60Hz		
Constant Voltage Mode			
Range	50-480Vrms / 700Vdc		
Resolution	0.0125V		
Accuracy	±(0.1% of setting + 0.1% of range)		
Constant Power Mode			
Range	2800W		3750W
Resolution	0.1W		0.1W
Accuracy	±(0.1% of setting + 0.1% of range)		
CREST FACTOR (CC & CP MODE ONLY)			
Range	2-5		
Resolution	0.1		
Accuracy	(0.5% / Irms) + 1% F.S.		
POWER FACTOR (CC & CP MODE ONLY)			
Range	0-1 Lag or Lead		
Resolution	0.01		
Accuracy	1% F.S.		
TEST MODE			
UPS Efficient Measurement			
Operating Frequency	Non-Linear Mode		
Current Range	Auto ; 40-70Hz		0-28A
PF Range	0-1		
Measuring Efficiency For PV Systems, Power Conditioners for THD 80%			
Operating Frequency	Auto ; 40-70Hz		
Current Range	0-18.75A		0-28A
Resistive Range	4 ohm - 80K ohm		2.5 ohm - 50K ohm
UPS Back-Up Function(CC,LIN,CR,CP)			
LVP (VTH)	50-480Vrms / 700Vdc		
LVP Back-Up Time	1-99999 Sec. (>27H)		
Battery Discharge Function(CC,LIN,CR,CP)			
LVP (VTH)	50-480Vrms / 700Vdc		
Battery Discharge Time	1-99999 Sec. (>27H)		
UPS Transfer Time			
Current Range	0-18.75A		0-28A
LVP (VTH)	2.5V		
Time range	0.15ms-999.99ms		
Fuse Test Mode			
Max. Current	Turbo OFF	18.75Arms	28.0Arms
	Turbo ON	37.5Arms (x2) *3	56.0Arms (x2) *3
Trip & Non-Trip Time	Turbo OFF	0.1-9999.9Sec.	
	Turbo ON	0.1-1.0Sec.	
Meas. Accuracy	±0.003 Sec.		
Repeat Cycle	0-255		
Short/OPP/OCF Test Function			
Short Time	Turbo OFF	0.1-10Sec. or Cont.	
	Turbo ON	0.1-1Sec.	
OPP/OCF Step Time	Turbo OFF	100ms	
	Turbo ON	100ms, up to 10 Steps	
OCF Istop	Turbo OFF	18.75Arms	28.0Arms
	Turbo ON	37.5Arms	56.0Arms
OPP Pstop	Turbo OFF	2800W	3750W
	Turbo ON	5600W	7500W
Programmable Inrush Current Simulation: Istart - Istop / Tsep			
Istart, Inrush Start Current	0-37.5A		0-56A
Inrush Step Time	0.1ms-100ms		
Istop, Inrush Stop Current	0-18.75A		0-28A
Programmable Surge Current Simulation: S1/T1 - S2/T2 - S3/T3			
S1 and S2 Current	0-37.5A		0-56A
T1 and T2 Time	0.01-0.5Sec.		
S3 Current	0-18.75A		0-28A
T3 Time	0.01-9.999Sec. or Cont.		
MEASUREMENTS			
VOLTAGE READBACK V METER			
Range	700V		
Resolution	0.0125V		
Accuracy	±0.05% of (reading + range)		
Parameter	Vrms,V Max/Min, +/-Vpk		
CURRENT READBACK A METER			
Range	9.375Arms/18.75Arms		14Arms/28Arms
Resolution	0.2mA/0.4mA		0.3mA/0.6mA
Accuracy	±0.05% of (reading + range) @ 50/60Hz		
Parameter	Irms,I Max/Min, +/-Ipk		
WATT READBACK W METER			
Range	2800W		3750W
Resolution	0.05W		0.0625W
Accuracy	±0.1% of (reading + range)		
VA METER	VrmsxArms Correspond To Vrms and Arms		
Power Factor METER			
Range	+/- 0.000-1.000		
Accuracy	±(0.002±(0.001/PF)*F)		
Frequency METER(V)			
Range	DC,40-70Hz		
Accuracy	0.1%		
Other Parameter METER			
VA, VAR, CF, I, Ipeak, Imax, Imin, Vmax, Vmin, IHD, VHD, ITHD, VTHD			
OTHERS			
Start up Loading	Yes, Power on loading during Inverter / UPS start up		
Load ON / OFF Angle	0 - 359 degree can be programmed for the angle of load ON and load OFF loading		
Half Cycle and SCR/TRIAC Loading	Positive or Negative half cycle, 90° Trailing edge or Leading edge current waveform can be programmed		
Master/Slave (3 Phase or Parallel Application)	Yes, 1 master and upto 7 slave units		
External Programming Input (OPTION)	F.S / 10Vdc, Resolution 0.1V		
External SYNC Input	TTL		
Vmonitor (Isolated)	±700V / ±10V		
Imonitor (Isolated)	±56.25Apk / ±10Vpk		±84Apk / ±10Vpk
Interface (OPTION)	GPIB ; RS-232 ; LAN ; USB		
MAX. Power Consumption	150VA		
Operation Temperature *2	0 - 40 °C		
Current of Input Impedance(mA)@50/60Hz ; @ 400Hz	-V*0.3 ; -V*2.2		-V*0.4 ; -V*2.95
Dimension (H x W x D)	177 x 440 x 558 mm		177 x 440 x 558 mm
Weight	27.5Kg		33.5Kg

PEL-022 GPIB Card



PEL-023 RS-232 Card



PEL-024 LAN Card



PEL-025 USB Card



PEL-028 HANDLES, U-shaped handle (for AEL-5006/5008/5012/5015)



PEL-029 HANDLES Rack Accessories (for AEL-5002/5003/5004)



*1 ms (millisiemens) is the unit of conductance(G), one siemens equal to 1/Ω
 *2 Operating temperature range is 0-40°C, all specification apply for 25°C±5°C, Except as noted
 *3 Turbo mode for up to 2X Current rating & Power rating support Fuse, Short/OPP/OPP test function

* All specifications apply for 50/60Hz
 * All specifications subject to change without notice
 * Input AC Power : 100-240 Vac ±10%, 50/60Hz, Single-phase

AC & DC Electronic Load

ORDERING INFORMATION

AEL-5002-350-18.75	350V/18.75A/1875W	AC & DC Electronic Load
AEL-5003-350-28	350V/28A/2800W	AC & DC Electronic Load
AEL-5004-350-37.5	350V/37.5A/3750W	AC & DC Electronic Load
AEL-5006-350-56	350V/56A/5600W	AC & DC Electronic Load
AEL-5008-350-75	350V/75A/7500W	AC & DC Electronic Load
AEL-5012-350-112.5	350V/112.5A/11250W	AC & DC Electronic Load
AEL-5015-350-112.5	350V/112.5A/15000W	AC & DC Electronic Load
AEL-5019-350-112.5	350V/112.5A/18750W	AC & DC Electronic Load
AEL-5023-350-112.5	350V/112.5A/22500W	AC & DC Electronic Load
AEL-5002-425-18.75	425V/18.75A/1875W	AC & DC Electronic Load
AEL-5003-425-28	425V/28A/2800W	AC & DC Electronic Load
AEL-5004-425-37.5	425V/37.5A/3750W	AC & DC Electronic Load
AEL-5006-425-56	425V/56A/5600W	AC & DC Electronic Load
AEL-5008-425-75	425V/75A/7500W	AC & DC Electronic Load
AEL-5012-425-112.5	425V/112.5A/11250W	AC & DC Electronic Load
AEL-5015-425-112.5	425V/112.5A/15000W	AC & DC Electronic Load
AEL-5019-425-112.5	425V/112.5A/18750W	AC & DC Electronic Load
AEL-5023-425-112.5	425V/112.5A/22500W	AC & DC Electronic Load
AEL-5003-480-18.75	480V/18.75A/2800W	AC & DC Electronic Load
AEL-5004-480-28	480V/28A/3750W	AC & DC Electronic Load

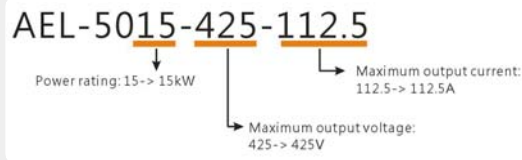

ACCESSORIES : HD-DSUB 15 PIN Parallel wire

OPTIONAL ACCESSORIES

PEL-022	GPIB Card	GTL-246	USB Cable, USB 2.0, A-B Type, 1200mm
PEL-023	RS-232 Card	GTL-248	GPIB Cable, Double Shielded, 2000mm
PEL-024	LAN Card	GTL-250	GPIB Cable, Double Shielded, 600mm
PEL-025	USB Card		
PEL-028	HANDLES, U-shaped handle(fixed to the bracket) (for AEL-5006/5008/5012/5015)		
PEL-029	HANDLES Rack Accessories(for AEL-5002/5003/5004)		
PEL-030	GPIB+RS-232 Card		

Note: * Regarding the product delivery date, please contact your regional sales representative.

Combined Test Solutions,
4 Commerce Way, Stanbridge Road,
Leighton Buzzard, LU7 4RW

T: 01525 374466
E: sales@ctstest.co.uk
W: www.ctstest.co.uk

