



Dual Measurement Multimeter

GDM-8351

USER MANUAL

PART NO. 82DM-83510E01



This manual contains proprietary information, which is protected by copyright. All rights are reserved. No part of this manual may be photocopied, reproduced or translated to another language without prior written consent of Good Will company.

The information in this manual was correct at the time of printing. However, Good Will continues to improve products and reserves the rights to change specification, equipment, and maintenance procedures at any time without notice.

Table of Contents

SAFETY INSTRUCTIONS	5
GETTING STARTED	10
Characteristics	11
Appearance	13
Set Up.....	23
OPERATION.....	28
Basic Measurement Overview	30
AC/DC Voltage Measurement.....	32
AC/DC Current Measurement	37
Resistance Measurement	42
Diode Test	45
Capacitance Measurement	46
Continuity Test.....	48
Frequency/Period Measurement	51
Temperature Measurement	53
Dual Measurement Overview	57
Advanced Measurement Overview	62
dBm/dB/W Measurement	63
Max/Min Measurement.....	66
Relative Measurement	67
Hold Measurement	69
Compare Measurement.....	70
Math Measurement.....	72
SYSTEM/DISPLAY CONFIGURATION	76
View Serial Number	77
View Version Number	77
Brightness Settings.....	78
Input Resistance Settings	79

Frequency/Period Input Jack Settings.....	80
Digital Filter.....	81
Restore Factory Default Settings	85
Trigger	86
DIGITAL I/O.....	88
Digital I/O Overview	89
REMOTE CONTROL	93
Configure Remote Control Interface	94
Return to Local Control	98
COMMAND OVERVIEW	99
Command Syntax	99
Command List.....	103
FAQ	138
APPENDIX	139
System Menu Tree.....	139
Factory Default Settings	140
Replacing the AC Source Fuse	141
Replacing the Input Fuse.....	142
Status system	144
Specifications	145
Additional Specifications	150
Dimensions	156
Declaration of Conformity.....	157
INDEX.....	158

S SAFETY INSTRUCTIONS

This chapter contains important safety instructions that you must follow during operation and storage. Read the following before any operation to ensure your safety and to keep the instrument in the best possible condition.

Safety Symbols

These safety symbols may appear in this manual or on the instrument.



WARNING

Warning: Identifies conditions or practices that could result in injury or loss of life.



CAUTION

Caution: Identifies conditions or practices that could result in damage to the DMM or to other properties.



DANGER High Voltage



Attention Refer to the Manual



Protective Conductor Terminal



Earth (ground) Terminal



Do not dispose electronic equipment as unsorted municipal waste. Please use a separate collection facility or contact the supplier from which this instrument was purchased.

Safety Guidelines

General Guideline • Make sure that the voltage input level does not exceed DC1000V/AC750V.



CAUTION

- Make sure the current input level does not exceed 12A.
- Do not place any heavy object on the instrument.
- Avoid severe impact or rough handling that can lead to damaging the instrument.
- Do not discharge static electricity to the instrument.
- Use only mating connectors, not bare wires, for the terminals.
- Do not block or obstruct the cooling fan vent opening.
- Do not perform measurement at the source of a low-voltage installation or at building installations (Note below).
- Do not disassemble the instrument unless you are qualified as service personnel.
- Make sure that the COM terminal to earth is limited to 500Vpk.
- Remove all test leads before disconnecting the mains power cord from the socket.

(Note) EN 61010-1:2010 specifies the measurement categories and their requirements as follows. The GDM-8351 falls under category II 600V.

- Measurement category IV is for measurement performed at the source of low-voltage installation.
 - Measurement category III is for measurement performed in the building installation.
 - Measurement category II is for measurement performed on the circuits directly connected to the low voltage installation.
-

- Power Supply
- AC Input voltage: 100/120/220/240 V AC
 - 50/60Hz
 - The power supply voltage should not fluctuate more than 10%.
 - Connect the protective grounding conductor of the AC power cord to an earth ground, to avoid electrical shock.
-



- Fuse
- Fuse type: 0.125AT 100/120VAC
0.063AT 220/240 VAC
 - Make sure the correct type of fuse is installed before power up.
 - To avoid risk of fire, replace the fuse only with the specified type and rating.
 - Disconnect the power cord before fuse replacement.
 - Make sure the cause of a fuse blowout is fixed before fuse replacement.
-



- Cleaning the Instrument
- Disconnect the power cord before cleaning.
 - Use a soft cloth dampened in a solution of mild detergent and water. Do not spray any liquid.
 - Do not use chemicals containing harsh material such as benzene, toluene, xylene, and acetone.
-

- Operation Environment
- Location: Indoor, no direct sunlight, dust free, almost non-conductive pollution (Note below)
 - Temperature: 0°C to 50°C
 - Humidity: 0~35°C: < 90%RH
>35°C: <80%RH
 - Altitude: <2000m

(Note) EN 61010-1:2010 specifies the pollution degrees and their requirements as follows. The GDM-8351 falls under degree 2.

- Pollution refers to “addition of foreign matter, solid, liquid, or gaseous (ionized gases), that may produce a reduction of dielectric strength or surface resistivity”.
- Pollution degree 1: No pollution or only dry, non-conductive pollution occurs. The pollution has no influence.
- Pollution degree 2: Normally only non-conductive pollution occurs. Occasionally, however, a temporary conductivity caused by condensation must be expected.
- Pollution degree 3: Conductive pollution occurs, or dry, non-conductive pollution occurs which becomes conductive due to condensation which is expected. In such conditions, equipment is normally protected against exposure to direct sunlight, precipitation, and full wind pressure, but neither temperature nor humidity is controlled.

Storage environment

- Location: Indoor
- Temperature: -40°C to 70°C
- Humidity: 0~35°C: <90%RH
>35°C: <80%RH

Disposal



Do not dispose this instrument as unsorted municipal waste. Please use a separate collection facility or contact the supplier from which this instrument was purchased. Please make sure discarded electrical waste is properly recycled to reduce environmental impact.

Power cord for the United Kingdom

When using the unit in the United Kingdom, make sure the power cord meets the following safety instructions.

NOTE: This lead/appliance must only be wired by competent persons



WARNING: THIS APPLIANCE MUST BE EARTHED

IMPORTANT: The wires in this lead are coloured in accordance with the following code:

Green/ Yellow:	Earth
Blue:	Neutral
Brown:	Live (Phase)



As the colours of the wires in main leads may not correspond with the coloured marking identified in your plug/appliance, proceed as follows:

The wire which is coloured Green & Yellow must be connected to the Earth terminal marked with either the letter E, the earth symbol  or coloured Green/Green & Yellow.

The wire which is coloured Blue must be connected to the terminal which is marked with the letter N or coloured Blue or Black.

The wire which is coloured Brown must be connected to the terminal marked with the letter L or P or coloured Brown or Red.

If in doubt, consult the instructions provided with the equipment or contact the supplier.

This cable/appliance should be protected by a suitably rated and approved HBC mains fuse: refer to the rating information on the equipment and/or user instructions for details. As a guide, a cable of 0.75mm² should be protected by a 3A or 5A fuse. Larger conductors would normally require 13A types, depending on the connection method used.

Any exposed wiring from a cable, plug or connection that is engaged in a live socket is extremely hazardous. If a cable or plug is deemed hazardous, turn off the mains power and remove the cable, any fuses and fuse assemblies. All hazardous wiring must be immediately destroyed and replaced in accordance to the above standard.

G E T T I N G S T A R T E D

This chapter describes the GDM-8351 multimeter in a nutshell, including accessories, package contents, its main features and front / rear panel introduction.

Characteristics	11
Accessories.....	12
Appearance	13
GDM-8351 Front Panel.....	13
Display Overview	19
Rear Panel	21
Set Up.....	23
Tilting the Stand.....	23
Power Up.....	24
How to Use the Instrument.....	25

Characteristics

The GDM-8351 is a portable, dual-display digital multimeter suitable for a wide range of applications, such as production testing, research, and field verification.

Performance	<ul style="list-style-type: none">• DCV accuracy: 0.012%• High current range: 10A• High Voltage range: 1000V• High ACV frequency response: 100kHz
Features	<ul style="list-style-type: none">• The fastest sampling rate is (320 Readings / sec) for ADC and PC transmission.• The diode test open-circuit voltage is \doteq 6V/1mA.• 120000 count display• Multiple functions: ACV, DCV, ACI, DCI, 2WR, 4WR, Cap, Freq, Period, Temp, Continuity, Diode test, MAX/MIN, Avg, REL, dB, dBm, Hold, MX+B, 1/X, REF, %, Compare.• Manual or Auto ranging• AC true RMS• Data logging to PC using an Excel Add-In.
Interface	<ul style="list-style-type: none">• USB device port supports USB CDC and USB TMC.• RS232• Digital I/O port can be used in either pass/fail testing (Compare function) or have the output state remotely controlled. Only one function at a time can be used.
Software	<ul style="list-style-type: none">• Excel Addins• LABVIEW driver

Accessories

Standard Accessories	Part number	Description
	82DM-83510E x1	CD-ROM (User Manual, Software, Driver)
	82DM-83511M x1	Safety Instruction Sheet
	GTL-207	Test leads
Optional Accessories	Part number	Description
	GTL-246	USB Cable, USB 2.0, A-B type, 1200mm
	GTL-205	Temperature Probe Adapter with Thermal Coupling (K-type)

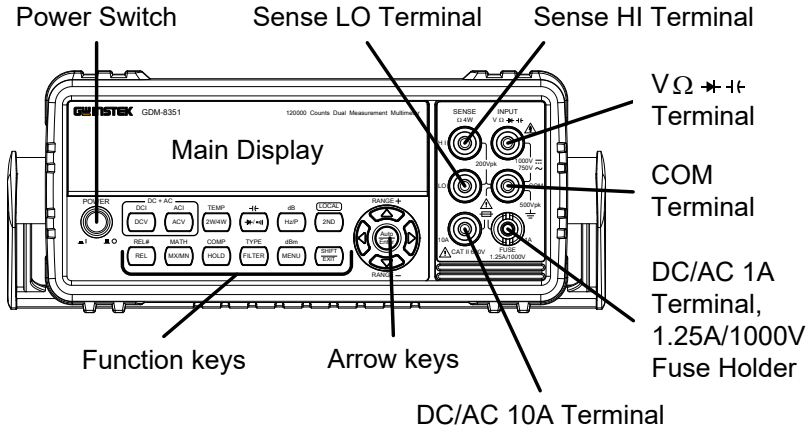

Appearance

GDM-8351 Front Panel

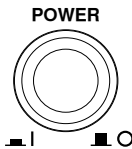

Power Switch



Turns On  or Off  the main power. For the power up sequence, see page 24.

Main Display

Shows measurement results and parameters. For display configuration details, see page 78 (brightness setting).

For an overview of the main display, see page 19.

V Ω → ← Input Terminal

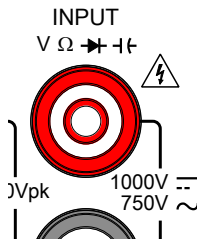

This terminal is used for all measurements except for DC/AC current measurements.

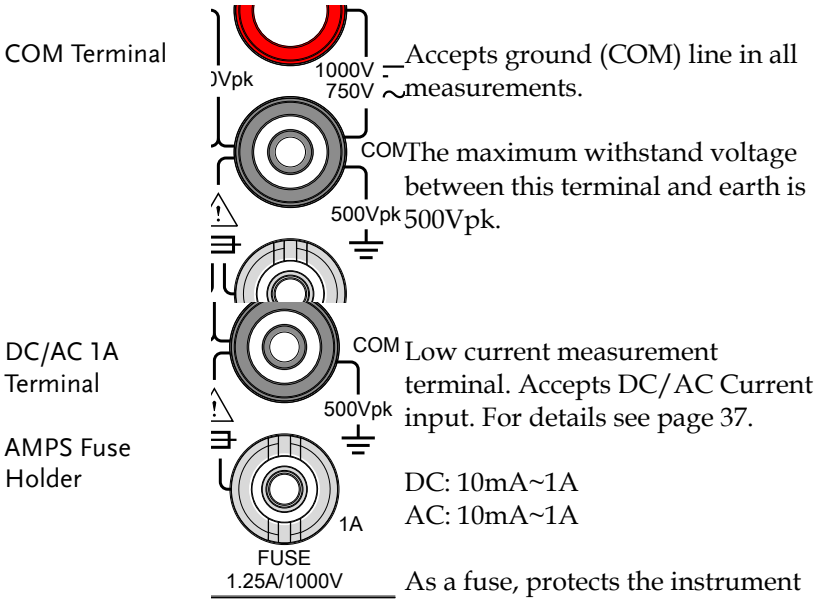

For the fuse replacement procedure, see page 142.

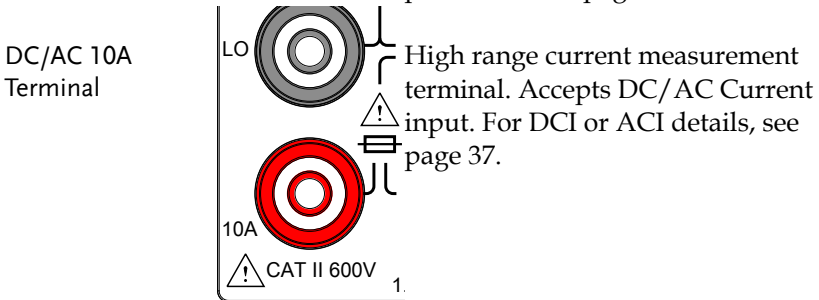

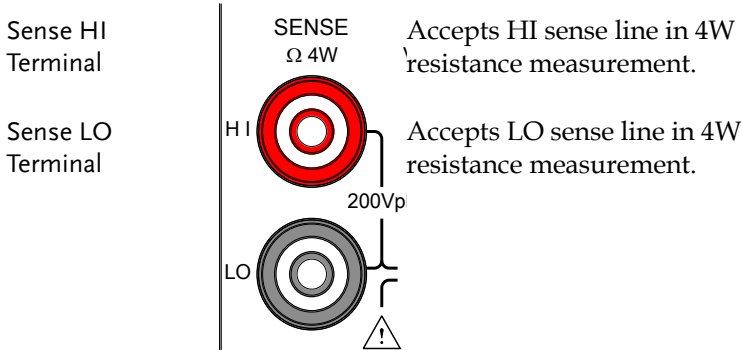



Measurement Keys
 The top row of measurement keys are used for basic DMM measurements such as voltage, current, resistance, capacitance and frequency. The bottom row of measurement functions are used for more advanced functions.

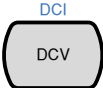

Each key has a primary and secondary function. The secondary function is accessed in conjunction with the SHIFT key.

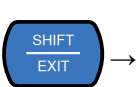
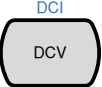
Upper Measurement keys

DCV  Measures DC Voltage (page 32).

DCI (SHIFT→DCV)  →  Measures DC Current (page 37).

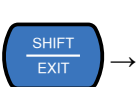
ACV  Measures AC Voltage (page 32).

ACI (SHIFT→ACV)  →  Measures AC Current (page 37).

DCV + ACV

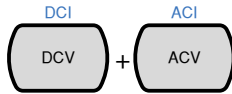

Measures DC + AC voltage (page 32).

DCI+ACI

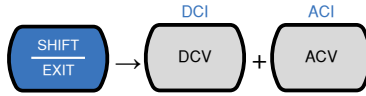

Measures DC + AC current (page 37).

2W/4W

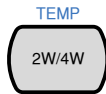

Measures resistance (2W or 4W) See page 42.

TEMP
(SHIFT → 2W/4W)

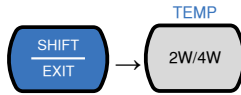

Measures temperature. See page 53.

→ / ∞)

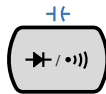

Measures diodes or continuity, depending on the selected mode. See page 45 and 48, respectively.

±
(SHIFT → → / ∞)

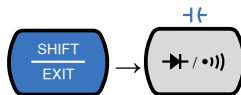

Measures capacitance. See page 46.

Hz/P

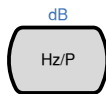

Measures the frequency or period of a signal, depending on the selected mode. See page 51.

dB
(SHIFT → Hz/P)

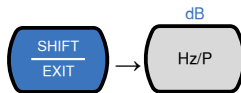

Measures dB. See page 65.

2ND



As the 2ND key, selects the measurement item on the 2nd display (page 57). Pressing and holding for more than 1 second turns off the 2nd display.

As the Local key, releases the unit from remote control and returns the instrument to local panel operation (page 97).

Lower Measurement keys

REL



Measures the Relative value (page 67).

REL#
(SHIFT→REL)

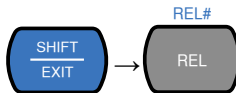

Manually sets the reference value for the Relative value measurement.

MX/MN

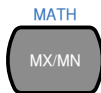

Measures the Maximum or the Minimum value (page 66).

MATH
(SHIFT→
MX/MN)

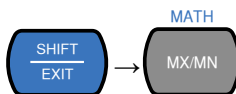

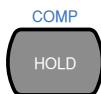

Enters the Math measurement mode. The supported math functions include $MX+B$, $REF\%$ and $1/X$. See page 72 for details.

HOLD

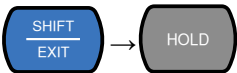

Activates the Hold function (page 69).

COMP
(SHIFT→HOLD)  Activates the compare measurement function. See page 70.

FILTER  Turns the digital filter on or off. See page 81.

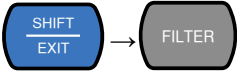
TYPE
(SHIFT→FILTER)  Sets the type of filter and the size of the rolling window. See page 82.

MENU  Enters the configuration menu for System Settings, Measurement Settings, Temperature measurement settings, I/O settings, Terminal character settings and Firmware installation. See page 76 for the system menu.

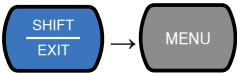
dBm
(SHIFT→MENU)  Measures dBm/W, see page 63.

SHIFT/EXIT  When used as a SHIFT key, it is used to access the secondary functions associated with the measurement keys.

When used as an EXIT key, it will exit out of menu systems.

AUTO/ENTER



When used as an AUTO key, it will set the range of the selected function to autorange.

When used as an ENTER key, it will confirm the entered value or menu item.

Arrow Keys

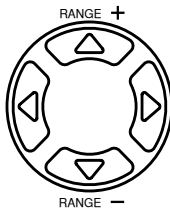

The arrow keys are used to navigate the menu system and edit values.

The Up and Down arrow keys will also manually set the range for the voltage and current measurements.

The Left and Right arrow keys will also toggle the refresh rate between the fast, medium and slow (F, M, S) rates.

Display Overview

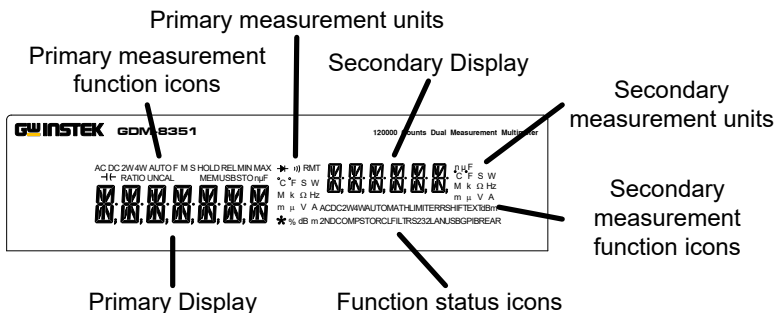

Primary Measurement Function Icons

Displays the primary measurement function.

Primary Measurement Units	Displays the units for the primary measurement function.
Secondary Display	Displays the results of the secondary measurement.
Secondary Measurement Units	Displays the units for the secondary measurement function.
Secondary Measurement function icons	Displays the secondary measurement function.
Function Status Icons	Display status icons for operations/functions that are not linked to the primary or secondary functions.
Primary Display	Displays the results of the primary measurement.

Rear Panel

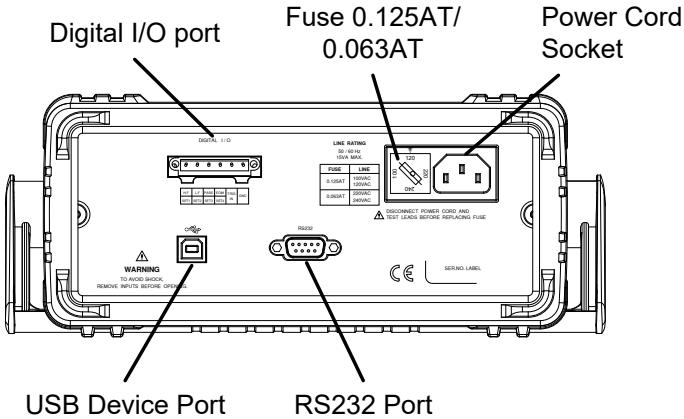

Digital I/O Port

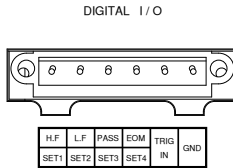

The Digital I/O port is used for outputting the comparison test results, external triggering and as a user-defined output port. See page 89.

Power Cord Socket

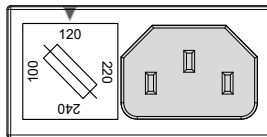

Accepts the power cord. AC 100/120/220/240V ±10%, 50/60Hz

For power on sequence, see page 24.

Fuse Socket

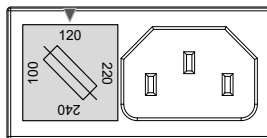

Holds the main fuse:

100/120 VAC: 0.125AT
220/240 VAC: 0.063AT

For fuse replacement details, see page 141.

RS232

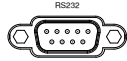

RS232 port. This port is used for remote control. See page 94.

USB Device Port

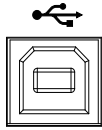

Type B USB port. This port is used for remote control. See page 94.

Set Up

Tilting the Stand

From the base of the handle, gently pull the handle out sideways and then rotate it to one of the following positions.

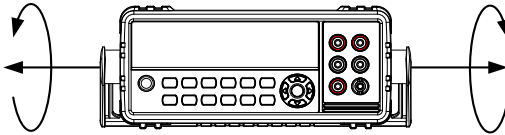

Horizontal
position

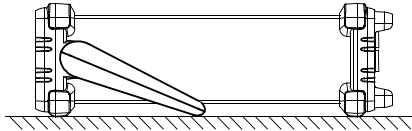

Tilt stand
position

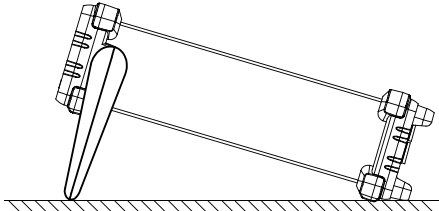

Carry position

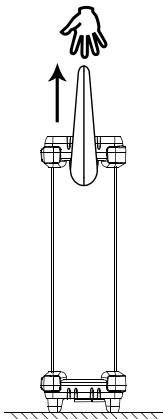

Power Up

Steps

1. Ensure the correct line voltage is lined up with the arrow on the fuse holder. If not, see page 141 to set the line voltage and fuse.

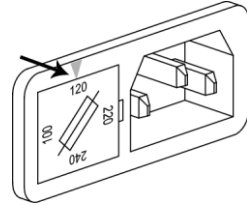

2. Connect the power cord to the AC voltage input.

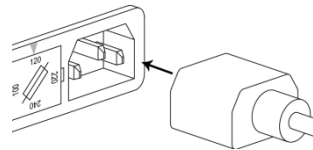

Note

Make sure the ground connector on the power cord is connected to a safety ground. This will influence the measurement accuracy.

3. Push to turn on the main power switch on the front panel.

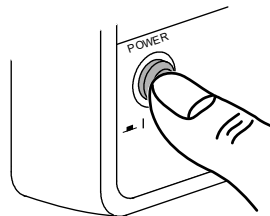

4. The display turns on and shows the last function that was used before the power was reset.

How to Use the Instrument

Background

The following section will introduce to you how to access the basic functions on the DMM as well as how to navigate the menu system and edit the parameter values.

Using the Function keys

Any of the primary functions can be used by simply pressing the desired function key.

For example:

To activate the DCV function, press the DCV key.

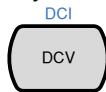

To activate a secondary function, first press the SHIFT key followed by the function key for the secondary function.

For example: To activate DCI measurement, first press the SHIFT key. SHIFT will be highlighted on the display. Next, press the DCV function key. This will activate the DCI mode.

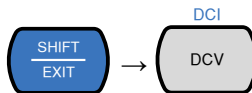

Navigating the Menu System

The menu system is navigated with the Up, Down, Left and Right arrow keys, the Auto/Enter key and the SHIFT/EXIT key.

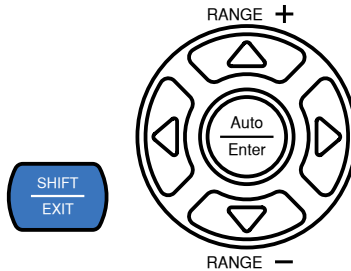

To enter the menu system, press the MENU key. See page 139 for the System Menu tree.

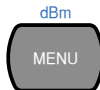

- Pressing the Left and Right arrow keys will navigate to each of the menu items on the current menu level.
- Pressing the Down key will go down to the next level of the menu tree.
- Conversely pressing the Up key will allow you to go back to the previous menu level.
- Pressing Down or Enter on the last item in a menu tree will allow you to edit the settings or parameters for that particular item or setting.
- Pressing the Exit key will allow you to exit from the current settings and return to the previous menu tree level.

Editing a Setting or Parameter

When you access a menu or parameter setting, the Up, Down, Left and Right keys can be used again to edit the parameter as well.

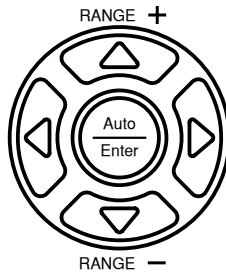

- If a setting or parameter is flashing, it indicates that that particular parameter can be edited.
- Pressing the Left or Right arrow key will allow you to select a digit or character to edit.
- Pressing the Up or Down keys will allow you to edit the selected character.

OPERATION

Basic Measurement Overview	30
Refresh Rate	30
Reading Indicator	31
Automatic/Manual Triggering	31
AC/DC Voltage Measurement	32
Select the Voltage Range	33
Voltage Conversion Table	35
Crest Factor Table	36
AC/DC Current Measurement	37
Select the Current Range	39
Resistance Measurement	42
Select the Resistance Range	44
Diode Test	45
Capacitance Measurement	46
Select the Capacitance Range	47
Continuity Test	48
Set Continuity Threshold	49
Continuity Beeper Settings	50
Frequency/Period Measurement	51
Frequency/Period Settings	52
Temperature Measurement	53
Set the Temperature Units	54
Select Thermocouple Type	55

Set the Reference Junction Temperature.....	56
Dual Measurement Overview.....	57
Supported dual measurement modes.....	57
Using Dual Measurement Mode.....	58
Advanced Measurement Overview	62
Supported Advanced Measurement Functions	62
dBm/dB/W Measurement.....	63
dBm/dB Calculation.....	63
Measuring dBm/W	63
Measure dB	65
Max/Min Measurement	66
Relative Measurement.....	67
Hold Measurement	69
Compare Measurement	70
Math Measurement	72
Math Measurement Overview	72
Measure MX+B	72
Measure 1/X.....	73
Measure Percentage.....	74

Basic Measurement Overview

Refresh Rate

Background The refresh rate defines how frequently the DMM captures and updates measurement data. A faster refresh rate yields a lower accuracy. A slower refresh rate yields a higher accuracy. Consider these tradeoffs when selecting the refresh rate.

For further details, please see the specifications.

Refresh rate (Reading/S)	Function	S	M	F
	Continuity/Diode	10	40	320
	DCV/DCI	10	40	320
	ACV/ACI	10	40	320
	Frequency/Period	1	9.8	83
	Temperature	10	40	320
	Resistance	10	40	320
	Capacitance	2	2	2

- Steps**
1. Press the left or right arrow keys to change the refresh rate.
 2. The refresh rate will be shown at the top of the display. F ↔ M ↔ S



Note

The refresh rate cannot be set for capacitance measurement.

Reading Indicator

Overview

1. The reading indicator * next to the 1st display flashes according to the refresh rate setting.

0000.078 *^v

Automatic/Manual Triggering

Overview

By default, the GDM-8351 automatically triggers according to the refresh rate. See the previous page for refresh rate setting details.

The TRIG IN pin of the digital I/O port or the *TRG remote command can be used to manually trigger acquisition when the trigger mode is set to EXT. See page 86 for trigger setting details.



Note

Manual triggering is not supported for capacitance measurements.

AC/DC Voltage Measurement

The GDM-8351 can measure up to 750VAC or 1000VDC, however the CATII measurement is only rated up to 600V.

Set to ACV/DCV Measurement

1. Press the DCV or ACV key to measure DC or AC voltage.
For AC + DC voltage, press the ACV and DCV keys at the same time.
2. The mode will switch to AC, DC or AC+DC mode immediately, as shown below.

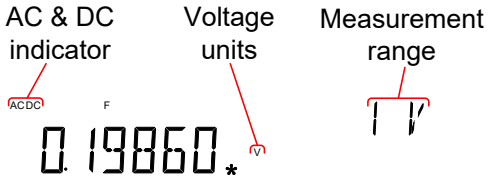

Connection

Connect the test lead between the VΩ \rightarrow and the COM terminal. The display updates the reading.

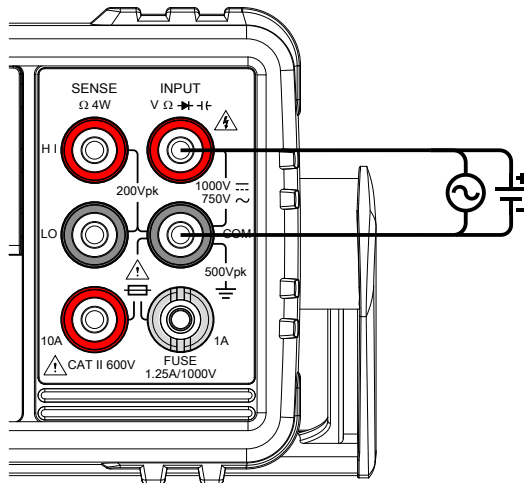

Select the Voltage Range

The voltage range can be set automatically or manually.

Auto Range	To turn the automatic range selection On/Off, press the AUTO key.
------------	---

Manual Range	Press the Up or the Down key to select the range. The AUTO indicator turns Off automatically. If the appropriate range is unknown, select the highest range.
--------------	--

Selectable Voltage Ranges	Range	Resolution	Full scale
		100mV	1 μ V
	1V	10 μ V	1.2V
	10V	0.1mV	12V
	100V	1mV	120V
	750V (AC)	10mV	765V
	1000V (DC)	10mV	1020V



Note

For further details, please see the specifications on page 145.



Note

DC voltages with AC components cannot be accurately measured if the DC+AC component exceeds the dynamic range for the selected DC range. Any voltage exceeding the dynamic range will be clipped at the upper/lower range limit. Under these conditions the range that is chosen with the Auto range function may be too small.

For example:

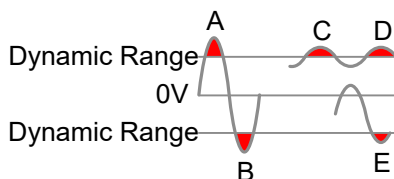

A,B: Input exceeds the dynamic range.

C,D: The DCV offset causes the input to exceed the upper dynamic range.

E: The DCV offset causes the input to exceed the lower dynamic range.





The DC voltage range should be manually selected when all of the following conditions are true:

- When DCV measurement is used.
- When the signals being measured contain both DC and AC components.
- When the amplitude of the AC component in the measured signal is higher or lower than the dynamic range of the range being currently selected by the auto-range function.

Maximum DCV Dynamic Range	Selected DCV Range	Dynamic Range
	DC 100mV	$\pm 180\text{mVmax}$
	DC 1V	$\pm 1.8\text{Vmax}$
	DC 10V	$\pm 18\text{Vmax}$
	DC 100V	$\pm 180\text{Vmax}$
	DC 1000V	$\pm 1000\text{Vmax}$

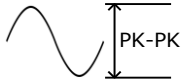
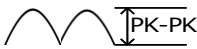
Voltage Conversion Table

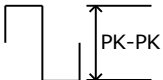
This table shows the relationship between an AC and DC reading for various waveforms.

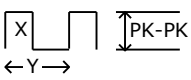
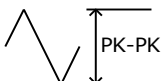







Waveform	Peak to Peak	AC (True RMS)	DC
Sine	2.828	1.000	0.000
			
Rectified Sine (full wave)	1.414	0.435	0.900
			
Rectified Sine (half wave)	2.000	0.771	0.636
			
Square	2.000	1.000	0.000
			
Rectified Square	1.414	0.707	0.707
			
Rectangular Pulse	2.000	$2K$ $K = \sqrt{(D - D^2)}$ $D = X/Y$	$2D$ $D = X/Y$
			
Triangle Sawtooth	3.464	1.000	0.000
			

Crest Factor Table

Background Crest factor is the ratio of the peak signal amplitude to the RMS value of the signal. It determines the accuracy of AC measurement.

If the crest factor is less than 3.0, voltage measurement will not result in error due to dynamic range limitations at full scale.

If the crest factor is more than 3.0, it usually indicates an abnormal waveform as seen from the below table.

Crest Factor Table	Waveform	Shape	Crest factor
	Square wave		1.0
	Sine wave		1.414
	Triangle sawtooth		1.732
	Mixed frequencies		1.414 ~ 2.0
	SCR output 100% ~ 10%		1.414 ~ 3.0
	White noise		3.0 ~ 4.0
	AC Coupled pulse train		>3.0
	Spike		>9.0

AC/DC Current Measurement

The GDM-8351 series DMMs have two input terminals for current measurement. A 1A terminal for current less than 1A and a 10A terminal for measurements up to 10A.

The units can measure 0 ~ 10A for both AC and DC current.

Set to AC/DC Measurement

1. Press SHIFT → DCV or SHIFT → ACV to measure DC or AC current, respectively.

For AC+DC current, press SHIFT followed by both the DCV and ACV key at the same time.

2. The mode will switch to AC, DC or AC+DC mode immediately, as shown below.

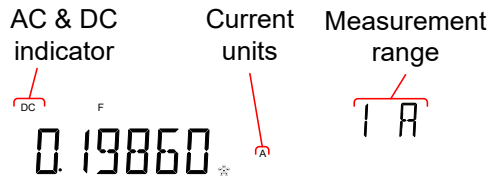

Connection

Connect the test lead between the 10A terminal and the COM terminal or DC/AC 1A terminal and the COM terminal, depending on the input current.

For current $\leq 1A$ use the 1A terminal; For current up to 10A use the 10A terminal. The display updates the reading.

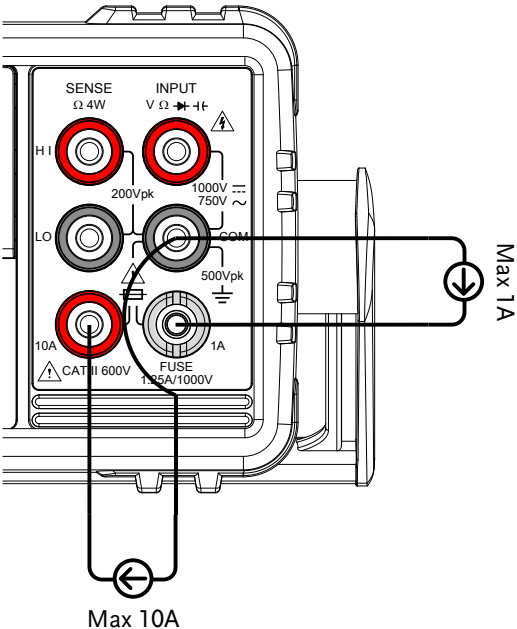

Select the Current Range

The current range can be set automatically or manually.

Auto Range To turn the automatic range selection On/Off, press the AUTO key. The most appropriate range for the currently used input jack will be automatically selected. The DMM is able to do this by remembering the last manually selected range and using that information to determine the smallest current range that the auto-range function will switch to.

When the current input is switched to another terminal, the range must be manually set.

Manual Range Press the Up or the Down key to select the range. The AUTO indicator turns Off automatically. If the appropriate range is unknown, select the highest range.

Selectable Current Ranges	Range	Resolution	Full scale	INJACK
	10mA	100nA	12mA	1A
	100mA	1μA	120mA	1A
	1A	100μA	1.2A	1A
	10A	1mA	12A	10A



Note

For further details, please see the specifications on page 145.



Note

DC currents with AC components cannot be accurately measured if the DC+AC component exceed the dynamic range for the selected DC range. Any current exceeding the dynamic range will be clipped at the upper/lower range limit. Under these conditions the range that is chosen with the Auto range function may be too small.

For example:

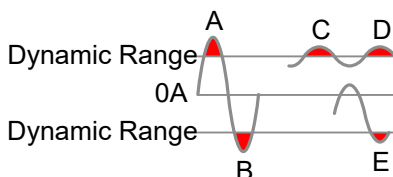

A,B: Input exceeds the dynamic range.

C,D: The DCI offset causes the input to exceed the upper dynamic range.

E: The DCI offset causes the input to exceed the lower dynamic range.

The DC current range should be manually selected when all of the following conditions are true:

- When DCI measurement is used.
- When the signals being measured contain both DC and AC components.
- When the amplitude of the AC component in the measured signal is higher or lower than the dynamic range of the range being currently selected by the auto-range function.

Maximum DCI Dynamic Range	Selected DCI Range	Dynamic Range
	DC 10mA	± 30mA max
	DC 100mA	± 300mA max
	DC 1A	± 1.25A max
	DC10A	± 12A max

Resistance Measurement

Measurement Type	2-wire	Uses the standard V-COM ports. Recommended for measuring resistances larger than 1k Ω .
	4-wire	Compensates the test lead effect using the 4W compensation ports(HI/LO sense ports), in addition to the standard V-COM ports. Recommended for measuring sensitive resistances smaller than 1k Ω .

Set to 2W or 4W Measurement

1. Press the 2W/4W key once to activate 2W resistance measurement.

Press the 2W/4W key twice to activate 4W resistance measurement.

2. The mode will switch to the selected resistance mode immediately, as shown below.

Display

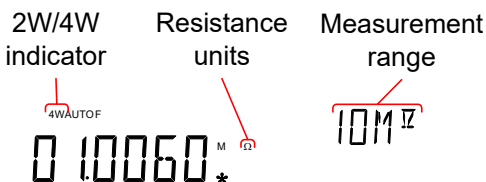

Connection

For 2W measurement, connect the test leads between the V Ω \rightarrow \leftarrow terminal and the COM terminal.

For 4W measurement, connect the test leads between the V Ω \rightarrow \leftarrow terminal and the COM terminal, as you would for 2W measurement. Connect the sense leads between the LO and HI sense terminals.

Select the Resistance Range

The resistance range can be set automatically or manually.

Auto Range	To turn the automatic range selection On/Off, press the AUTO key.
------------	---

Manual Range	Press the Up or the Down key to select the range. The AUTO indicator turns Off automatically. If the appropriate range is unknown, select the highest range.
--------------	--

Selectable Resistance Ranges	Range	Resolution	Full scale
	100Ω	1mΩ	120Ω
	1kΩ	10mΩ	1.2kΩ
	10kΩ	100mΩ	12kΩ
	100kΩ	1Ω	120kΩ
	1MΩ	10Ω	1.2MΩ
	10MΩ	100Ω	12MΩ
	100MΩ	1kΩ	120MΩ



Note

For further details, please see the specifications on page 147.

Diode Test

The diode test checks the forward bias characteristics of a diode by running a constant forward bias current of approximately 1mA through the DUT.

Set to Diode Measurement

1. Press the \rightarrow/\bullet key once to activate diode measurement.
Note: pressing the \rightarrow/\bullet key twice will activate the continuity measurement instead.
2. The mode will switch to Diode mode immediately, as shown below.

Display

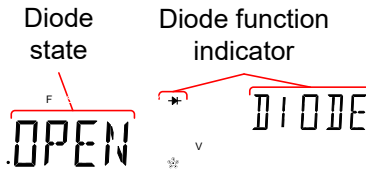

Connection

Connect the test lead between the $V\Omega\rightarrow/\bullet$ terminal and COM terminal; Anode-V, Cathode-COM. The display updates the reading.

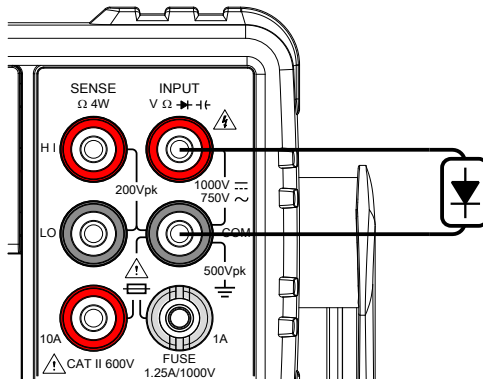

Capacitance Measurement

The capacitance measurement function checks the capacitance of a component.

Set to
Capacitance
Measurement

1. Press the SHIFT → \rightarrow (F) keys to activate capacitance measurement.
2. The mode will switch to capacitance mode immediately, as shown below.

Display

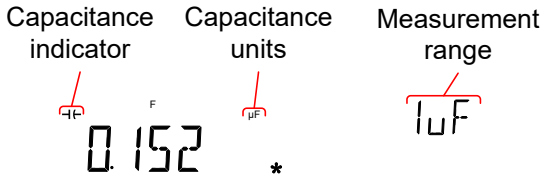

Connection

Connect the test lead between the V Ω \rightarrow (F) terminal and COM terminal; Positive-V, Negative-COM. The display updates the reading.

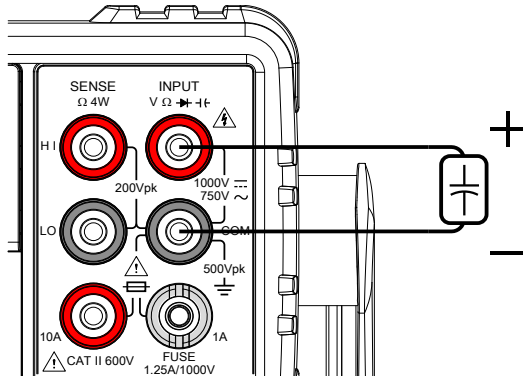

Select the Capacitance Range

The capacitance range can be set automatically or manually.

Auto Range	To turn the automatic range selection On/Off, press the AUTO key.
------------	---

Manual Range	Press the Up or the Down key to select the range. The AUTO indicator turns Off automatically. If the appropriate range is unknown, select the highest range.
--------------	--

Selectable Capacitance Ranges	Range	Resolution	Full scale
	10nF	10pF	12nF
	100nF	100pF	120nF
	1μF	1nF	1.2μF
	10μF	10nF	12μF
	100μF	100nF	120μF



Note

For further details, please see the specifications on page 149.



Note

The refresh rate settings and the EXT trigger cannot be used in the capacitance mode.

Continuity Test

The continuity test checks that the resistance in the DUT is low enough to be considered continuous (of a conductive nature).

- Procedure
1. Press the \rightarrow/Ω key *twice* to activate continuity testing.
Note: pressing the \rightarrow/Ω key once will activate diode testing.
 2. The mode will switch to continuity testing immediately, as shown below.

Display

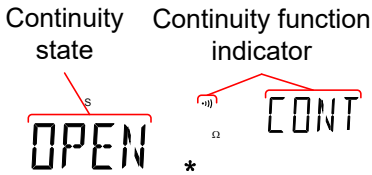

Connection

Connect the test lead between the $V\Omega \rightarrow/\Omega$ terminal and COM terminal. The display updates the reading.

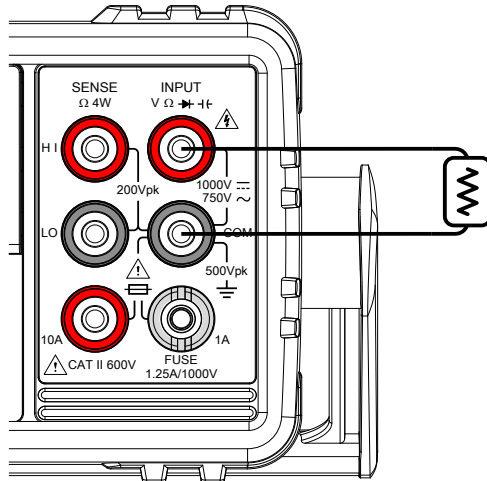

Set Continuity Threshold

The continuity threshold defines the maximum resistance allowed in the DUT when testing the continuity.

Range	Threshold	0 to 1000Ω (Default Threshold: 10Ω)
	Resolution	1Ω

- Procedure
1. Press MENU.
 2. Go to the MEAS menu on level 1
 3. Go to the CONT menu on level 2
 4. Set the continuity threshold level in ohms.
 5. Press the Enter key to confirm the continuity settings.
 6. Press EXIT to exit the CONT setting menu.

Display

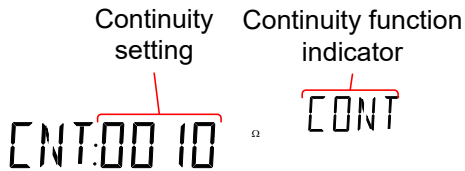

Continuity Beeper Settings

The beeper setting defines how the GDM-8351 notifies the continuity test result to the user.

Note: When the Beeper setting is off it will also turn off the keypad tones as well as any error or warning tones.

Range	PASS	Beeps when the continuity passes.
	FAIL	Beeps when the continuity fails.
	OFF	Beeper is turned off.

- Procedure
1. Press MENU.
 2. Go to the SYSTEM menu on level 1
 3. Go to the BEEP menu on level 2
 4. Set the BEEP setting to PASS, FAIL or OFF.
 5. Press the Enter key to confirm the beeper settings.
 6. Press EXIT to exit the BEEP setting menu.

Display

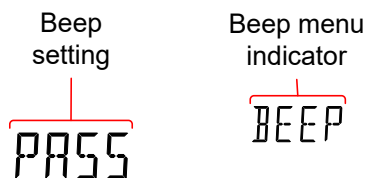

Frequency/Period Measurement

The GDM-8351 can be used to measure the frequency or period of a signal. This function can measure either the voltage frequency/period or current frequency/period, depending on which jack the input signal is input from.

Range	Frequency	10Hz~1MHz
	Period	1.0 μ s ~100ms

Procedure

To measure frequency, press the Hz/P key once. The frequency will be displayed on the primary screen and the range will be displayed on the secondary display.

To measure the period, press the Hz/P key twice. The period will be displayed on the primary screen and the range will be displayed on the secondary display.

Display

Frequency or Voltage/Current Measurement period units range setting

Connection

Connect the test lead between the V Ω \rightarrow \rightarrow terminal and the COM terminal. The display updates the reading.

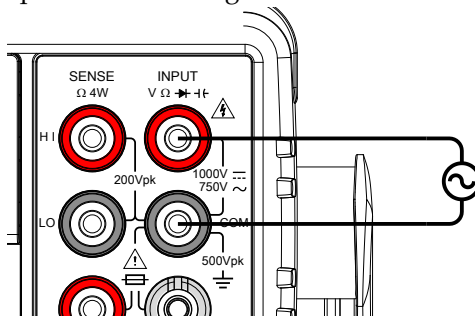

Frequency/Period Settings

The input voltage/current range for frequency/period measurements can be set to Auto range or to Manual. By default, the voltage/current range is set to Auto for both the period and frequency.

Range	Voltage	100mV, 1V, 10V, 100V, 750V
	Current	10mA, 100mA, 1A, 10A



Note

The input jack setting determines whether the voltage frequency/period or current frequency/period is being measured. See page 80 for details.

Manual Range Set the range with the Up and Down keys. The AUTO indicator will turn off when a new range is selected.

Autorange

1. Press the Auto/Enter key.
2. AUTO will be displayed on the screen again.

Display	Autorange indicator	Voltage/Current range setting

Note Pressing the 2nd key twice will toggle the view of the second display between the voltage/current range and the menu function (FREQ or PERIOD).

Note that the voltage/current range can actually still be set even when the secondary display has been toggled to show the menu function.

Temperature Measurement

The GDM-8351 can measure temperature using a thermocouple. To measure temperature, the DMM accepts a thermocouple input and calculates the temperature from the voltage fluctuation. The thermocouple type and reference junction temperature are also considered.

Temperature Range & Type	Thermocouple: -200°C ~ +300°C
	Type: J, K, T

Procedure To make temperature measurements, press SHIFT → 2W/4W (TEMP). The temperature mode appears showing the temperature on the primary display and the type of sensor on the secondary display.

Display

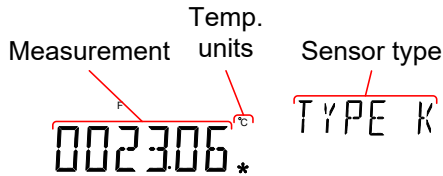

Connection

Connect the sensor lead between the VΩ terminal and the COM terminal. The display updates the reading.

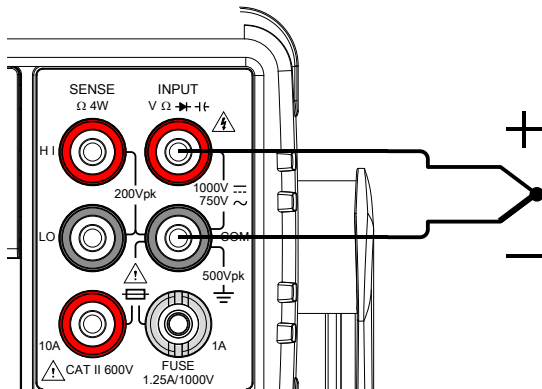

Set the Temperature Units

Range	Units	°C, °F
-------	-------	--------

- Procedure
1. Press the MENU key.
 2. Go to TEMP on level 1.
 3. Go to UNIT on level 2.
 4. Select either C (Celsius) or F (Fahrenheit).
 5. Press the Enter key to confirm.
 6. Press the EXIT key to exit from the temperature menu.

Display

Temperature
unit setting

Unit menu
indicator

UNIT: F

UNIT

Select Thermocouple Type

The GDM-8351 accepts thermocouple inputs and calculates the temperature from the voltage difference of two dissimilar metals. Thermocouple type and reference junction temperature are also considered.

Thermocouple type and range	Type	Measurement Range	Resolution
	J	-200 to +300 °C	0.01 °C
	K	-200 to +300 °C	0.01 °C
	T	-200 to +300 °C	0.01 °C

- Procedure
1. Press the MENU key.
 2. Go to TEMP on level 1.
 3. Go to SENSOR on level 2.
 4. Select the thermocouple type (J, K, T).
 5. Press the Enter key to confirm.
 6. Press the EXIT key to exit from the temperature menu.

Display

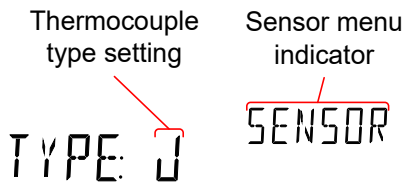

Set the Reference Junction Temperature

When a thermocouple is connected to the DMM, the temperature difference between the thermocouple lead and the DMM input terminal should be taken into account and be cancelled out; otherwise an erroneous temperature might be added. The value of the reference junction temperature should be determined by the user.

Range	SIM	0 ~ 50°C (default: 23.00°C)
	Resolution	0.01°C

- Procedure
1. Press the MENU key.
 2. Go to TEMP on level 1.
 3. Go to SIM on level 2.
 4. Set the SIM (simulated) reference junction temperature.
 5. Press the Enter key to confirm.
 6. Press the EXIT key to exit from the temperature menu.

Display

Reference junction
temperature setting

21.20

SIM menu
indicator

SIM

Dual Measurement Overview

The dual measurement mode allows you to use the 2nd display to show another item, thus allowing you to view two different measurement results on the screen.

When the multimeter is used in dual measurement mode, both displays are updated from either a single measurement or from two separate measurements. If the primary and secondary measurement modes have the same range, rate and rely on the same fundamental measurement, then a single measurement is taken for both displays; such as ACV and frequency/period measurements. If the primary and secondary displays use different measurement functions, ranges or rates, then separate measurements will be taken for each display. For example, ACV and DCV measurements.

Most of the basic measurement functions, except for resistance/continuity can be used in the dual measurement mode.

Supported Dual Measurement Modes

The following table lists all the measurement functions that are supported with the dual measurement function.

Supported Dual Measurement modes	Primary Display	Secondary Display					
		ACV	DCV	ACI	DCI	Hz/P	Ω
ACV		●	●	●	●	●	X
DCV		●	●	●	●	X	X
ACI		●	●	●	●	●	X
DCI		●	●	●	●	X	X
Hz/P		●	X	●	X	●	X
Ω		X	X	X	X	X	●

Using Dual Measurement Mode

Procedure

1. Choose one of the basic measurement functions from the table above to set the measurement mode for the primary display.

For example, press DCV to set the first display to DCV measurement.

2. To set a measurement mode for the second display, press the 2ND key and then select the second measurement mode.

For example, press 2ND, SHIFT, ACV(ACI) to select ACI measurement for the second display.

Display

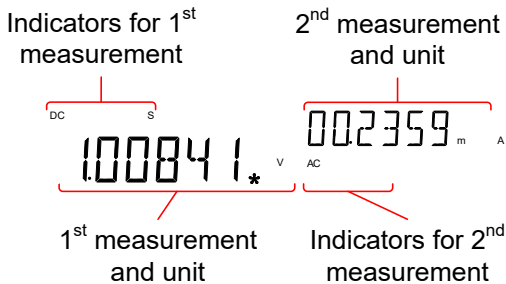

Editing the Measurement Parameters

After the secondary measurement function has been activated, the rate, range and measurement item can be edited for either the primary or secondary display. Note however, it is more practical to configure the first or second measurement items before activating dual measurement mode.

To edit measurement parameters in dual measurement mode, you must first set which display is the *active* display. The 2ND icon under the secondary display determines which display is the active display.

Procedure

1. Toggle whether the primary or secondary display is the active display by pressing the 2ND key:

Primary display is the active display: 2ND *is not* visible on the display.

Secondary display is the active display: 2ND *is* visible on the display.



Do not hold the 2ND key. This will turn the dual measurement mode off.

2. Edit the range, rate or measurement item for the active display in the same way as for single measurement operation. See the Basic Measurement chapter for details (page 30).
-

Turn Off 2nd Measurement

To turn Off the second measurement, press and hold the 2ND key for more than 1 second.

Voltage/Frequency/Period and Current Measurement

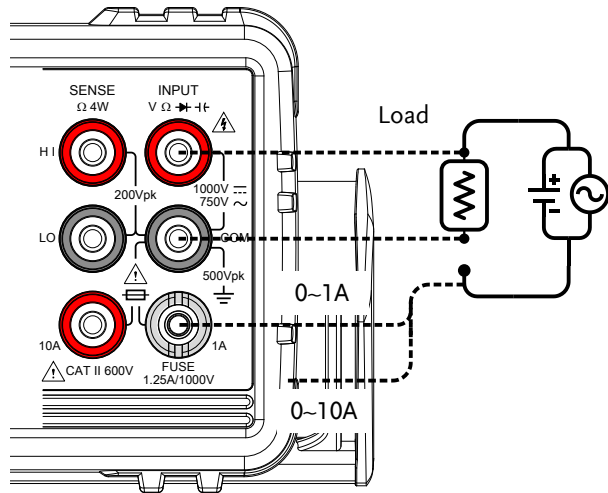

Note: DC Current measurements will be displayed as a negative value as the polarity of the current leads has been reversed.

Please take into account the resistance of the test leads and internal resistance of the current connection as it is in series with the test circuit.

The above measuring configuration is used to measure the voltage present on the resistance under test and the current through the resistance under test when using the DCI/DCV or ACI/ACV dual measurement function.

Advanced Measurement Overview

Advanced measurement mainly refers to the type of measurement which uses the result obtained by one of the basic measurements: ACV, DCV, ACI, DCI, Resistance, Diode/Continuity, Frequency/Period, and Temperature.

Supported Advanced Measurement Functions

The following table lists all the advanced measurement functions and which of the basic measurement functions that they support.

Advanced Meas.	Basic Measurement						
	ACV/ DCV	ACI/ DCI	Ω	Hz/P	TEMP	DIODE	CAP
dB	•	X	X	X	X	X	X
dBm	•	X	X	X	X	X	X
Max/Min	•	•	•	•	•	X	•
Relative	•	•	•	•	•	X	•
Hold	•	•	•	•	•	X	X
Compare	•	•	•	•	•	X	•
Math	•	•	•	•	•	X	X

dBm/dB/W Measurement

dBm/dB Calculation

Overview Using the ACV or DCV measurement results, the DMM calculates the dB or dBm value based on a reference resistance value in the following way:

$$\text{dBm} = 10 \times \log_{10} (1000 \times V_{\text{reading}}^2 / R_{\text{ref}})$$

$$\text{dB} = \text{dBm} - \text{dBm}_{\text{ref}}$$

$$W = V_{\text{reading}}^2 / R_{\text{ref}}$$

Where:

V_{reading} = Input Voltage, ACV or DCV;

R_{ref} = Reference resistance simulating an output load;

dBm_{ref} = Reference dBm value

Measuring dBm/W

- Procedure
1. Select ACV or DCV measurement. See page 32.
 2. To measure dBm, press SHIFT → MENU(dBm)

The primary display will show the dBm measurement while the secondary display shows the reference resistance.

Display



Setting the Reference Resistance

To set the reference resistance, use the Up and Down arrow keys.

The selectable reference resistances are shown below.

Selectable reference resistances

2	4	8	16	50	75	93
110	124	125	135	150	250	300
500	600	800	900	1000	1200	8000

View the result in Watts

When the reference resistance is less than 50Ω, it is possible to calculate the power (in watts). If the reference resistance is equal to or greater than 50Ω, then this step can be ignored.

Press SHIFT → MENU(dBm) again to view the result in watts.

Display

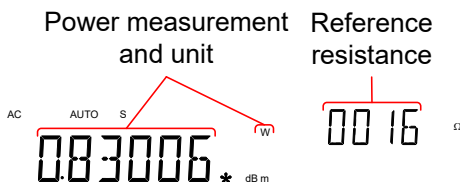

Exit dBm Measurement

Press SHIFT → MENU(dBm) again to exit the dBm measurement, or simply activate another measurement function.

Measure dB

dB is defined as [dBm-dBmref]. When the dB measurement is activated, the DMM calculates the dBm using the reading at the first moment and stores it as dBmref.

- Procedure
1. Select ACV or DCV measurement. See page 32.
 2. Press the SHIFT → Hz/P(dB) keys to activate the dB measurement mode.

The 1st display shows the dB reading, the second display shows the voltage reading.

Display

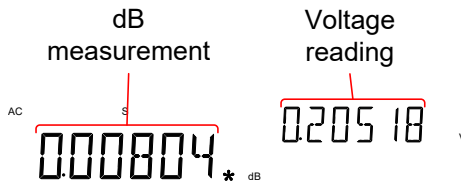

View the dBm Reference Value

To view the dBm reference value, press the 2ND key.

The Up and Down arrow keys can also be used to change the voltage range or the reading.

Exit dB Measurement

Press the SHIFT → Hz/P(dB) keys again to exit the dB measurement, or simply activate another measurement function.

Max/Min Measurement

Maximum and Minimum measurement function stores the highest (maximum) or lowest (minimum) reading and shows it on the first display when the 2ND key is pressed.

Applicable measurements	The Max/Min function can be used with the following basic measurement functions: ACV, DCV, ACI, DCI, Ω , Hz/P, TEMP, \pm
Procedure	For Max measurement, press the MX/MN key once. For Min measurement, press the MX/MN key twice.

Display	Basic meas. function	Max/Min indicator	Measurement range
	AC	S	MAX
	0205 17.* V		V

View Max/Min Value	Press the 2ND key to view the Max or Min value.
--------------------	---

Display	Max/Min reading	Max/Min mode
	AC	S
	MAX	←-MAX
	0205 17.* V	

Deactivate Max/Min Measurement	Hold the MX/MN key for two seconds to deactivate, or simply activate another measurement function.
--------------------------------	--

Relative Measurement

Relative measurement stores a value, typically the data at that instant, as the reference. The measurement following the reference is displayed as the delta between the reference. The reference value will be cleared upon exiting.

Applicable measurements

The relative function can be used with the following basic measurement functions: ACV, DCV, ACI, DCI, Ω , Hz/P, TEMP, \pm

Procedure

Press the REL key. The measurement reading at that instant becomes the reference value.

Display



View Relative Reference Value

Press the 2ND key to view the relative reference value at full scale.

Display

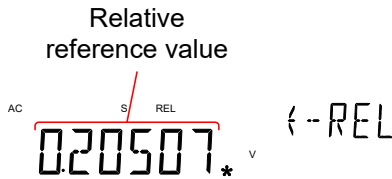

Manually Set the Relative Reference Value

1. To manually set the relative reference value, press SHIFT → REL(REL#).

The REL value is displayed on the screen at full scale.

2. Use the Left and Right arrow keys to navigate to the digit to be edited or to select the decimal point.

Use the Up and Down arrow keys to edit the selected digit or to place the position of the decimal point.



3. Press the Enter key to confirm, alternatively press Exit to cancel setting the relative reference value.

Display

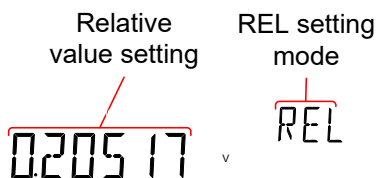

Deactivate Relative Measurement

Press the REL key again to deactivate the Relative measurement mode, or simply activate another measurement function.

Hold Measurement

The Hold Measurement function retains the current measurement data and updates it only when it exceeds the set threshold (as a percentage of the retained value).

Applicable measurements The hold function can be used with the following basic measurement functions: ACV, DCV, ACI, DCI, Ω , Hz/P, TEMP

- Procedure**
1. Press the HOLD key.
 2. The measurement reading appears on the primary display and the hold threshold on the secondary display.

Display



Set the Hold Threshold Use the Up and Down arrow keys to select a hold threshold level, as a percentage.

Range 0.01%, 0.1%, 1%, 10%

Deactivate Hold Measurement Press the HOLD key for 2 seconds to deactivate the hold measurement, or simply activate another measurement function.

Compare Measurement

Compare measurement checks to see if the measurement data stays between a specified upper (high) and lower (low) limit.

Applicable measurements The compare function can be used with the following basic measurement functions:
ACV, DCV, ACI, DCI, Ω , Hz/P, TEMP, \pm

- Procedure
1. Press SHIFT → HOLD(COMP).
 2. The high limit setting appears.

Use the Left and Right arrow keys to navigate to the digit to be edited, or to select the decimal point.

Use the Up and Down arrow keys to edit the selected digit, or to place the position of the decimal point.



3. Press the Enter key to save the high limit setting and automatically go on to the low limit setting.
4. Enter the low limit setting in the same fashion as the high setting.
5. Press the Enter key to confirm the low limit settings.
6. The compare measurement results will appear immediately:

If the current measurement reading is between

the high and low limits, PASS will be displayed on the secondary display, If the reading is below the low limit, LOW will be displayed. If the reading is above the high limit, HIGH will be displayed.

Display

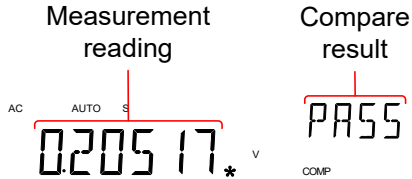

Deactivate
Compare
Measurement

Press SHIFT → HOLD(COMP) to deactivate compare measurements, or simply activate another measurement function.

Math Measurement

Math Measurement Overview

Math measurement runs three types of mathematical operations, MX+B, 1/X and Percentage based on the other measurement results.

Applicable Measurements	The math function can be used with the following basic measurement functions: ACV, DCV, ACI, DCI, Ω, Hz/P, TEMP	
Overview of Math Functions	MX+B	Multiplies the reading (X) by the factor (M) and adds/subtracts offset (B).
	1/X	Inverse. Divides 1 by the reading (X).
	Percentage	Runs the following equation: $\frac{(\text{Reading}X - \text{Reference})}{\text{Reference}} \times 100\%$

Measure MX+B

- Procedure
1. Press SHIFT → MX/MN(MATH) to enter the MATH menu.

The MX+B setting appears. The M factor will be flashing, indicating that the M factor is to be set.
 2. Use the Left and Right arrow keys to navigate to the digit to be edited or to select the decimal point.

Use the Up and Down arrow keys to edit the selected digit or to place the position of the

decimal point.

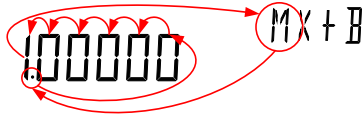

3. Press Enter to confirm the M factor settings and to automatically move onto the B offset setting.
4. Edit the B offset in the same fashion as the M factor was edited.
5. Press Enter to confirm the B offset setting and to begin the MX+B measurement.

Display

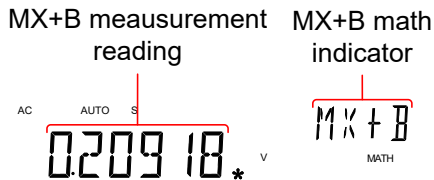

Deactivate Math Measurement

Press SHIFT → MX/MN(MATH) to deactivate the MATH function, or simply activate another measurement function.

Measure 1/X

Procedure

1. Press SHIFT → MX/MN(MATH) to enter the MATH menu.

The MX+B setting appears.

2. Press the Down key twice to skip past MX+B settings and go to the 1/X settings.

1/X will be flashing in the secondary display.

INVERSE 1/x

3. Press Enter to activate the 1/X math function.
The results begin immediately.

Display

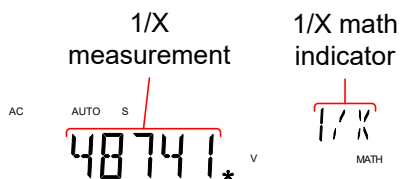

Deactivate Math
Measurement

Press the SHIFT → MX/MN(MATH) to deactivate the MATH function, or simply activate another measurement function.

Measure Percentage

Procedure

1. Press SHIFT → MX/MN to enter the MATH menu.
2. The MX+B setting appears. Press the Up key to skip past MX+B settings and go to the REF% settings.

REF% will be flashing in the secondary display.

3. Use the Left and Right arrow keys to navigate to the digit to be edited or to select the decimal point.

Use the Up and Down arrow keys to edit the selected digit or to place the position of the decimal point.



4. Press Enter to confirm the REF% setting and to begin the Percentage measurement.

Display

Calculated percentage measurement

% function indicator



Deactivate Math Measurement

Press SHIFT → MX/MN to deactivate the MATH function, or simply activate another measurement function.

S

SYSTEM/DISPLAY

CONFIGURATION

View Serial Number.....	77
View Version Number.....	77
Brightness Settings	78
Input Resistance Settings	79
Frequency/Period Input Jack Settings	80
Digital Filter.....	81
Digital Filter Overview	81
Digital Filter Type Settings.....	83
Restore Factory Default Settings.....	85
Trigger	86
Trigger Settings.....	86
External Trigger	87

View Serial Number

- Procedure
1. Press the MENU key.
 2. Go to SYSTEM on level 1.
 3. Go to S/N on level 2.
 4. The serial number will be displayed across both the primary and secondary display.

Display

SN: GDM 990001

Exit Press the EXIT key twice to go back to the measurement screen.

View Version Number

- Procedure
1. Press the MENU key.
 2. Go to FW on level 1.
 3. Go to VER on level 2.
 4. The firmware version number will be displayed in the secondary display.
 5. Press Exit to exit from the version menu.

Display

VERSION V 100



Note

For details about firmware updates, please contact the GW Instek Service Center or visit the GW Instek website at www.gwinstek.com.

Brightness Settings

The display has 5 settable brightness levels.

Range	Brightness	1 (dim) ~ 5 (bright)
-------	------------	----------------------

- | | |
|-----------|--|
| Procedure | <ol style="list-style-type: none"> 1. Press the MENU key. 2. Go to SYSTEM on level 1. 3. Go to LIGHT on level 2. 4. Set the light setting between 1 (dim) and 5 (bright). 5. Press the Enter key to confirm. 6. Press the EXIT key to exit from the brightness settings. |
|-----------|--|

Display	Brightness setting
---------	--------------------

LIGHT 3 LEVEL 3

Input Resistance Settings

The 100mV and 1V DC voltage ranges can be set to an input resistance of 10MΩ or 10GΩ. This setting is only applicable for DC voltage.

Range	Input resistance	10MΩ, 10GΩ
	Default	10MΩ

- Procedure
1. Press the MENU key.
 2. Go to MEAS on level 1.
 3. Go to INPUT R on level 2.
 4. Set the input resistance to 10MΩ or 10GΩ
 5. Press the Enter key to confirm.
 6. Press the EXIT key to exit from the input resistance menu.

Display

Input resistance
setting

10G

INPUT

Frequency/Period Input Jack Settings

The INJACK settings set which input terminal is used for frequency or period measurements.

Range	Injack	VOLT, 1A, 10A
	Default	VOLT

- Procedure
1. Press the MENU key.
 2. Go to MEAS on level 1.
 3. Go to INJACK on level 2.
 4. Set the INJACK setting to either VOLT, 1A or 10A.
 5. Press the Enter key to confirm.
 6. Press the EXIT key to exit from the INJACK menu.

Display INJACK setting



VOLT

INJACK

Digital Filter

Digital Filter Overview

Filter Basics The digital filter converts the analog input signal into digital format before passing it to the internal circuits for processing. The filter affects the amount of noise included in the measurement result.

Filter Type The digital filter averages a specific number of input signal samples to generate one reading. The filter type defines the averaging method. The following diagrams show the differences between each filter type, using 4 samples per reading as an example.

Moving Filter The moving filter takes in one new sample and discards the oldest sample per reading. This is the default behavior when the digital filter is not specified, and is recommended for most applications.

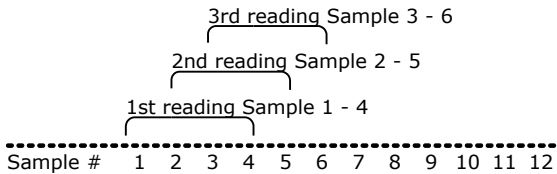

Repeating Filter The repeating filter renews all the samples per reading.

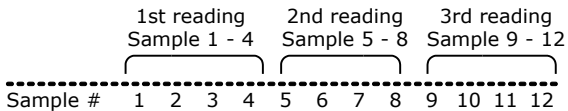

Filter Count Filter count defines the number of samples to be averaged per reading. More samples offer low noise but a longer delay between measurements. Less samples offer high noise but a shorter delay between measurements.

Range: 2 ~ 320

Filter Window The filter window defines the threshold for when the digital filter data is updated again. When the AD data falls in the range between TH and TL, the filter keeps processing. When the AD data falls out of the range between TH and TL, the filter will restart. When measuring unstable signals, appropriately setting the filter window can improve the measurement speed.

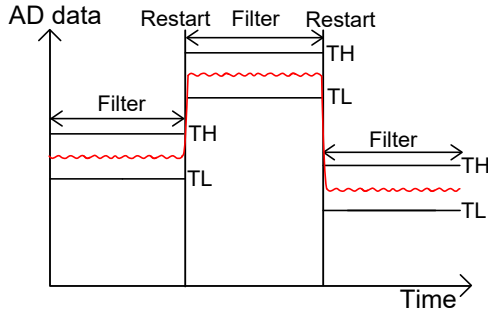

TH: Threshold High, TL: Threshold Low

Filter Window Formula $\text{Previous data} \cdot (1 - \text{window}) < \text{threshold} < \text{previous data} \cdot (1 + \text{window})$.

Range: 10%, 1%, 0.1%, 0.01% and none

Digital Filter Type Settings

Procedure

1. Press SHIFT → FILTER(TYPE) to enter the (Digital Filter) Type settings menu.
2. Use the Left and Right arrow keys to navigate to the filter type setting or to select the digit to be edited.

Use the Up and Down arrow keys to edit the selected digit or to toggle the filter type (REP<>MOV).

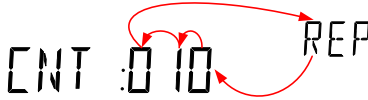

3. Press Enter to confirm the filter type and the CNT setting. The DMM will now automatically go to the WINDOW setting.
4. Use the Up and Down arrow keys to set the window threshold settings.



5. Press Enter to confirm the settings.
6. Press EXIT to cancel.

Display



Filter indicator



Deactivate Digital
Filter

Press FILTER to deactivate the FILTER
function.

Restore Factory Default Settings

The factory default settings can be restored at anytime from the System menu. Please see the Appendix on page 140 for a list of the factory default settings.

Range	Factory DEF	YES, NO
Procedure	<ol style="list-style-type: none"> 1. Press the MENU key. 2. Go to SYSTEM on level 1. 3. Go to FACTORY on level 2. 4. Set the (FACTORY) DEF setting to YES or NO. Choosing YES will restore the factory default settings. 5. Press the Enter key to confirm and to restore the factory default settings immediately. <p>“OK DEF” will be displayed when the default settings are restored.</p>	

Display Factory default setting

DEF

Trigger

The measurements can be triggered internally or externally. When set to internal, the DMM will be triggered automatically according to the refresh rate. When set to external, the DMM will wait for an external trigger signal from the Digital I/O port or from the *TRG command. See page 88 & 137 for more details.

Trigger Settings

Range	Trigger	INT, EXT
Procedure	<ol style="list-style-type: none"> 1. Press the MENU key. 2. Go to MEAS on level 1. 3. Go to TRIG on level 2. 4. Set the TRIG setting to either INT or EXT. 5. Press the Enter key to confirm. 6. Press the EXIT key to exit from the TRIG menu. 	
Display	INJACK setting	
		TRIG

External Trigger

The external trigger uses the digital I/O pin for manual triggering of the DMM. Pin 5 of the digital I/O port is normally high. To trigger the DMM a low pulse of $\geq 10\mu\text{s}$ is needed.

The *TRG command can also be used to externally trigger the DMM when the DMM is in the external trigger mode. See page 137 for details.

Digital I/O

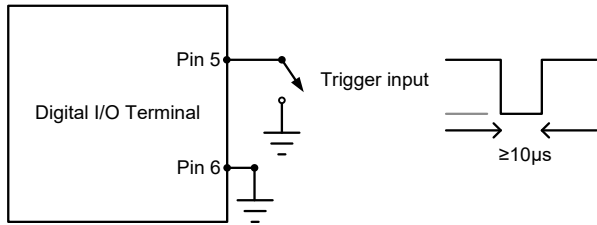

DIGITAL I/O

Digital I/O Overview 89

 Normal Mode..... 90

 User Mode..... 91

Digital I/O Overview

The Digital I/O port is a dual function port. By default (Normal Mode) the port is used with the compare function to output Hi Fail, Lo Fail, Pass, and EOM (end of measurement) signals. In addition there is also a TRIG IN input pin.

As a secondary function (User Mode), the Digital I/O port can have the output state of pins 1 ~4 controlled via remote control.

Pinout

DIGITAL I/O

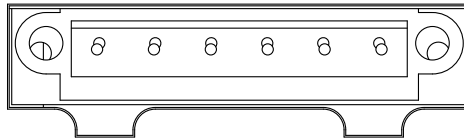

H.F	L.F	PASS	EOM	TRIG	GND
SET1	SET2	SET3	SET4	IN	

Pin No.	Normal Mode	User Mode
1	High Fail	Set 1
2	Low Fail	Set 2
3	Pass	Set 3
4	EOM	Set 4
5	TRIG IN	TRIG IN
6	Ground	Ground

Wiring Diagram
Pins 1 ~ 4

Pins 1 ~ 4 are open-collector outputs, with a max input of 30mA. All outputs are active low.

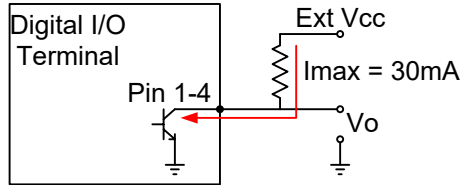

Wiring Diagram
Trig In (Pin 5)

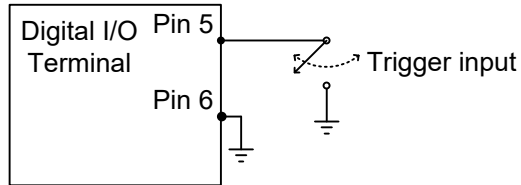

Normal Mode

Overview

The Normal Mode outputs the pass/fail results of the Compare function. Each signal is an active low signal. In addition an active low pulse of approximately 5 μ s is output to indicate the end of compare measurement (EOM).

When the input signal exceeds the high threshold or the low threshold, the High Fail or Low Fail pin is pulled low. When the signal stays within the threshold levels, the Pass pin is pulled low.

Timing Diagram

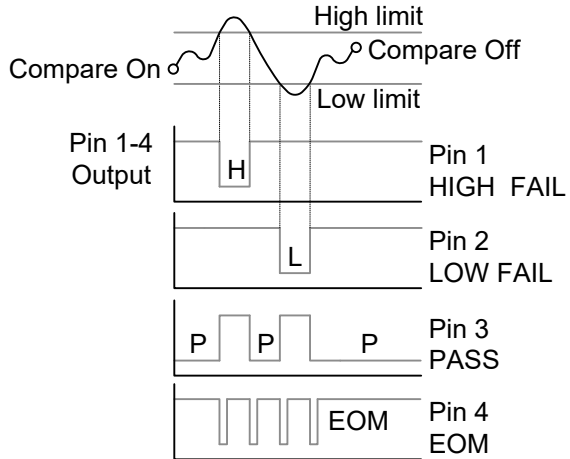

User Mode

User mode can only be used when using a remote control interface. Likewise this mode can only be enabled or disabled via remote control. Please see the digital I/O commands on page 133 for full usage details.

Related Commands	DIGitalio:MODE {USER NORM ?} DIGitalio{X}:SETup {ON OFF}
------------------	---

- | | |
|-----------|---|
| Procedure | <ol style="list-style-type: none"> 1. Connect to the GDM-8351 remotely, see page 93 for remote control options. 2. Enable the user mode using the DIGitalio:MODE command. See page 133. 3. Set the state of pins 1 ~ 4 using the DIGitalio{X}:SETup command. See page 133. |
|-----------|---|
-

Example	DIG:MODE?	Queries the mode.
	>NORM	Returns Norm mode.
	DIG:MODE USER	Sets to USER mode.
	DIG1:SETup ON	Turns pin1 output on.
	DIG2:SETup ON	Turns pin2 output on.
	DIG3:SETup ON	Turns pin3 output on.
	DIG4:SETup ON	Turns pin4 output on.
	DIG4:SETup?	Queries pin4 output state.
	>1	Returns pin4 output state.
	DIG:MODE NORM	Sets back to NORM mode.

RREMOTE CONTROL

This chapter describes basic configuration of IEEE488.2 based remote control. For a command list, refer to the Command Overview chapter on page 99.

Configure Remote Control Interface.....	94
USB Interface	94
Configure USB Interface	94
Configure RS232 Interface	95
Configure EOL Character	97
Return to Local Control	98

Configure Remote Control Interface

USB Interface

The USB device port on the rear panel is used for remote control. The USB port can be configured as either a TMC or CDC interface.

When configured as a TMC interface, the DMM can be controlled using National Instruments NI-Visa software*. NI-Visa version 3.0 and above supports USB TMC.

When configured to CDC, the USB port on the DMM will appear as a virtual COM port to a connected PC. Any terminal program that can communicate via a serial port can be used for remote control. Before the DMM can be used for remote control using the CDC or TMC USB class, install the appropriate CDC or TMC USB driver included on the User Manual CD.



Note

*To use the TMC interface National Instruments Measurement and Automation Explorer can be used. This program is available on the NI website, www.ni.com, via a search for the VISA Run-time Engine page, or “downloads” at the following URL, <http://www.ni.com/visa/>

Configure USB Interface

USB Configuration	PC connector	Type A, host
	DMM connector	Rear panel Type B, slave
	Speed	1.1/2.0 (full speed/high speed)
	USB Class	TMC (USB T&M class), CDC (Communications device class)
	Hardware flow control	Off
	Data Bits	8
	Stop bit	1

- Steps
1. Connect the USB cable to the rear panel type B USB port.
 2. Press MENU.
 3. Go to I/O on level 1.
 4. Go to USB on level 2.
 5. Select USB-CDC or USB-TMC.

Display

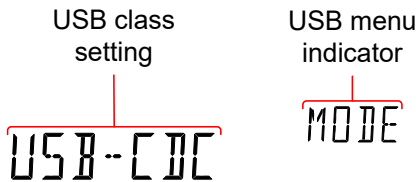

Configure RS232 Interface

RS232 Configuration	Selectable Baud rate	9600, 19200, 38400, 57600, 115200
	Parity	None
	Hardware flow control	Off
	Data Bits	8
	Stop bit	1

- Steps
1. Connect the RS232 cable to the rear panel RS232 port.

2. Press MENU.
3. Go to I/O on level 1.
4. Go to RS232 on level 2 and press Enter.
5. The baud rate settings appear. Set the baud rate.
6. Press Enter to confirm the RS232 settings.
7. Press EXIT to exit from the System menu.

Display

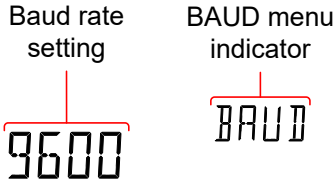

RS232 Pin Assignments

Pin 2: RxD
 Pin 3: TxD
 Pin 5: GND
 Pin 1, 4, 6 ~ 9: No Connection

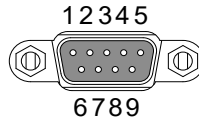

PC Connection

Use a Null Modem connection as shown in the diagram below.

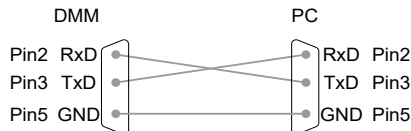

Configure EOL Character

Overview The TX EOL settings set the EOL (end of line) character for return messages. The EOL characters that can be received from a PC include CR, LF, CR+LF or LF+CR, with CR+LF being the most common.

EOL Characters CR+LF, LF+CR, CR, LF

- Steps**
1. Press MENU.
 2. Go to TX TERM on level 1.
 3. Go to TX EOL on level 2.
 4. Set the EOL character.
 5. Press Enter to confirm the EOL settings.
 6. Press EXIT to exit from the System menu.

Display

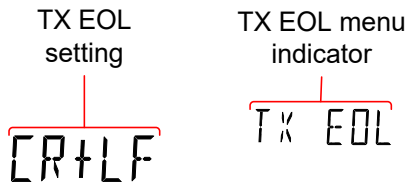

Return to Local Control

Background When the unit is in remote control mode, the RMT icon above the main display can be seen. When this icon is not displayed, it indicates that the unit is in local control mode.

- Procedure**
1. Press the LOCAL/2ND key when in remote mode.
 2. The unit will go back into local mode and the RMT icon will turn off.

Display

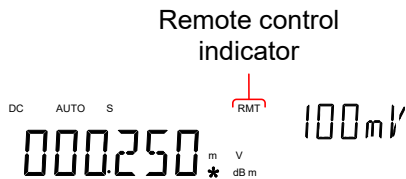

COMMAND OVERVIEW

The Command overview chapter lists all programming commands in functional order as well as alphabetical order. The command syntax section shows you the basic syntax rules you have to apply when using commands.

Command Syntax

Compatible Standard	IEEE488.2	Partial compatibility
	SCPI, 1994	Partial compatibility

Command Structure

SCPI (Standard Commands for Programmable Instruments) commands follow a tree-like structure, organized into nodes. Each level of the command tree is a node. Each keyword in a SCPI command represents each node in the command tree. Each keyword (node) of a SCPI command is separated by a colon (:). For example, the diagram below shows an SCPI sub-structure and a command example.

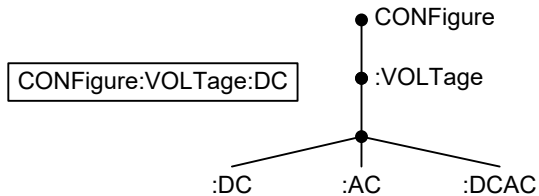

Command Types There are a number of different instrument commands and queries. A command sends instructions or data to the unit and a query receives data or status information from the unit.

Command types

Simple A single command with/without a parameter

Example CONFigure:VOLTage:DC

Query A query is a simple or compound command followed by a question mark (?). A parameter (data) is returned.

Example CONFigure:RANGe?

Command Forms Commands and queries have two different forms, long and short. The command syntax is written with the short form of the command in capitals and the remainder (long form) in lower case.

The commands can be written either in capitals or lower-case, just so long as the short or long forms are complete. An incomplete command will not be recognized.

Below are examples of correctly written commands.

Long form CONFigure:DIODe
 CONFIGURE:DIODE
 Configure:diode

Short form CONF:DIOD
 conf:diod

Square Brackets Commands that contain square brackets indicate that the contents are optional. The function of the command is the same with or without the square bracketed items, as shown below. For example, for the query:

[SENSe:]UNIT?
Both SENSE:UNIT? and UNIT? are valid forms.

Command
Format

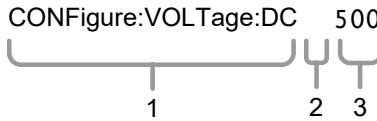

1. Command header
2. Space
3. Parameter 1

Common Input Parameters	Type	Description	Example
	<Boolean>	boolean logic	0, 1
	<NR1>	integers	0, 1, 2, 3
	<NR2>	decimal numbers	0.1, 3.14, 8.5
	<NR3>	floating point with exponent	4.5e-1, 8.25e+1
	<NRf>	any of NR1, 2, 3	1, 1.5, 4.5e-1
	[MIN] (Optional parameter)	For commands, this will set the setting to the lowest value. This parameter can be used in place of any numerical parameter where indicated. For queries, it will return the lowest possible value allowed for the particular setting.	

[MAX] (Optional parameter)	<p>For commands, this will set the setting to the highest value. This parameter can be used in place of any numerical parameter where indicated.</p> <p>For queries, it will return the highest possible value allowed for the particular setting.</p>
Automatic parameter range selection	<p>The GDM-8351 automatically sets the command parameter to the next available value.</p>
Example	<p>conf:volt:dc 2</p> <p>This will set the measurement item to DC Voltage and the range to 10V. There is no 2V range so the DMM selects the next available range, 10V.</p>
Message Terminator (EOL)	<p>Remote Command</p> <p>Marks the end of a command line. The following messages are in accordance with IEEE488.2 standard.</p> <p>LF, CR, CR+LF, LF+CR</p> <p>The most common EOL character is CR+LF</p>
Message Separator	<p>EOL or ; (semicolon)</p> <p>Command Separator</p>

Command List

Configure Commands (Display 1)

CONFigure:VOLTage:DC.....	108
CONFigure:VOLTage:AC.....	108
CONFigure:VOLTage:DCAC.....	108
CONFigure:CURRent:DC.....	108
CONFigure:CURRent:AC.....	109
CONFigure:CURRent:DCAC.....	109
CONFigure:RESistance.....	109
CONFigure:FRESistance.....	109
CONFigure:FREQuency.....	110
CONFigure:PERiod.....	110
CONFigure:CONTInuity.....	110
CONFigure:DIODE.....	110
CONFigure:TEMPerature:TCOuple.....	110
CONFigure:CAPacitance.....	111
CONFigure:FUNCTion?.....	111
CONFigure:RANGe?.....	111
CONFigure:AUTO.....	111
CONFigure:AUTO?.....	111

Configure Commands (Display 2)

CONFigure2:VOLTage:DC.....	112
CONFigure2:VOLTage:AC.....	112
CONFigure2:CURRent:DC.....	112
CONFigure2:CURRent:AC.....	112
CONFigure2:RESistance.....	113
CONFigure2:FRESistance.....	113
CONFigure2:FREQuency.....	113
CONFigure2:PERiod.....	113
CONFigure2:OFF.....	113
CONFigure2:FUNCTion?.....	114
CONFigure2:RANGe?.....	114
CONFigure2:AUTO.....	114
CONFigure2:AUTO?.....	114

Measure Commands

MEASure:VOLTage:DC?	115
MEASure:VOLTage:AC?	115
MEASure:VOLTage:DCAC?	115
MEASure:CURRent:DC?	115
MEASure:CURRent:AC?	116
MEASure:CURRent:DCAC?	116
MEASure:RESistance?	116
MEASure:FRESistance?	116
MEASure:FREQuency?	116
MEASure:PERiod?	117
MEASure:CONTInuity?	117
MEASure:DIODE?	117
MEASure:CAPacitance?	117
MEASure:TEMPerature:TCouple?	117
MEASure2:VOLTage:DC?	118
MEASure2:VOLTage:AC?	118
MEASure2:CURRent:DC?	118
MEASure2:CURRent:AC?	118
MEASure2:RESistance?	118
MEASure2:FRESistance?	119
MEASure2:FREQuency?	119
MEASure2:PERiod?	119

Sense Commands

[SENSe:]TEMPerature:TCouple:TYPE	119
[SENSe:]TEMPerature:TCouple:TYPE?	119
[SENSe:]TEMPerature:RJUNction:SIMulated	120
[SENSe:]TEMPerature:RJUNction:SIMulated?	120
[SENSe:]DETector:RATE	120
[SENSe:]DETector:RATE?	120
[SENSe:]AVERage:TCONtrol	120
[SENSe:]AVERage:TCONtrol?	120
[SENSe:]AVERage:COUNT	121
[SENSe:]AVERage:COUNT?	121
[SENSe:]AVERage:WINDow	121
[SENSe:]AVERage:WINDow?	121
[SENSe:]AVERage:STATe	121
[SENSe:]AVERage:STATe?	121
[SENSe:]FREQuency:INPutjack	122

[SENSe:]FREQuency:INPutjack?	122
[SENSe:]PERiod:INPutjack	122
[SENSe:]PERiod:INPutjack?	122
[SENSe:]CONTinuity:THReshold	122
[SENSe:]CONTinuity:THReshold?	122
[SENSe:]UNIT	123
[SENSe:]UNIT?	123
[SENSe:]FUNctIon[1/2]	123
[SENSe:]FUNctIon[1/2]?	123

Calculate Commands

CALCulate:FUNctIon	124
CALCulate:FUNctIon?	124
CALCulate:STATe	124
CALCulate:STATe?	124
CALCulate:MINimum?	124
CALCulate:MAXimum?	124
CALCulate:HOLD:REFerence	125
CALCulate:HOLD:REFerence?	125
CALCulate:REL:REFerence	125
CALCulate:REL:REFerence?	125
CALCulate:LIMit:LOWer	125
CALCulate:LIMit:LOWer?	125
CALCulate:LIMit:UPPer	125
CALCulate:LIMit:UPPer?	126
CALCulate:DB:REFerence	126
CALCulate:DB:REFerence?	126
CALCulate:DBM:REFerence	126
CALCulate:DBM:REFerence?	126
CALCulate:MATH:MMFactor	126
CALCulate:MATH:MMFactor?	126
CALCulate:MATH:MBFactor	127
CALCulate:MATH:MBFactor?	127
CALCulate:MATH:PERCent	127
CALCulate:MATH:PERCent?	127

Trigger Commands

READ?	128
VAL1?	128
VAL2?	128

TRIGger:SOURce	129
TRIGger:SOURce?	129
TRIGger:AUTO	129
TRIGger:AUTO?	129
SAMPlE:COUNT	129
SAMPlE:COUNT?	129
TRIGger:COUNT	130
TRIGger:COUNT?	130

System Commands

SYSTem:BEEPer:STATe	131
SYSTem:BEEPer:STATe?	131
SYSTem:BEEPer:ERRor	131
SYSTem:BEEPer:ERRor?	131
SYSTem:BEEPer	131
SYSTem:ERRor?	131
SYSTem:VERSion?	131
SYSTem:DISPlay	132
SYSTem:DISPlay?	132
SYSTem:SERial?	132
INPut:IMPedance:AUTO	132
INPut:IMPedance:AUTO?	132
DISPlay:TEXT	132
DISPlay:TEXT?	132
DISPlay:TEXT:CLEar	133
DIGitalio:MODE	133
DIGitalio:MODE?	133
DIGitalio[1 2 3 4]:SETup	133
DIGitalio[1 2 3 4]:SETup?	133

Status Commands

STATus:QUESTionable:ENABLE	134
STATus:QUESTionable:ENABLE?	134
STATus:QUESTionable:EVENT?	134
STATus:PRESet	134

Interface Commands

SYSTem:LOCal	134
SYSTem:REMote	134
SYSTem:RWLock	135

Common Commands

*CLS	135
*ESE?	135
*ESE	135
*ESR?	135
*IDN?	136
*OPC?	136
*OPC	136
*PSC?	136
*PSC	136
*RST	136
*SRE?	136
*SRE	136
*STB?	137
*TRG.....	137

CONFigure Commands

CONFigure:VOLTage:DC

Sets measurement to DC Voltage on the first display and specifies the range.

Parameter: [None] | [Range(<NRf> | MIN | MAX | DEF)]

Example: CONF:VOLT:DC 1

Sets the voltage range to 1 volt.

CONFigure:VOLTage:AC

Sets measurement to AC Voltage on the first display and specifies the range.

Parameter: [None] | [Range(<NRf> | MIN | MAX | DEF)]

Example: CONF:VOLT:AC

Sets the AC range to auto range.

CONFigure:VOLTage:DCAC

Sets measurement to DC+AC Voltage on the first display and specifies the range.

Parameter: [None] | [Range(<NRf> | MIN | MAX | DEF)]

Example: CONF:VOLT:DCAC

Sets the DC+AC voltage range to auto range.

CONFigure:CURRent:DC

Sets measurement to DC Current on the first display and specifies the range.

Parameter: [None] | [Range(<NRf> | MIN | MAX | DEF)]

Example: CONF:CURR:DC 10e-3

Sets the DC current range to 10mA.

CONFigure:CURRent:AC

Sets measurement to AC Current on the first display and specifies the range.

Parameter: [None] | [Range(<NRf> | MIN | MAX | DEF)]

Example: CONF:CURR:AC 10e-2

Sets the measurement mode to ACI with a 100mA range.

CONFigure:CURRent:DCAC

Sets measurement to DC+AC Current on the first display and specifies the range.

Parameter: [None] | [Range(<NRf> | MIN | MAX | DEF)]

Example: CONF:CURR:DCAC 10e-2

Sets the measurement mode to DC+AC Current with a 100mA range.

CONFigure:RESistance

Sets measurement to 2W Resistance on the first display and specifies range.

Parameter: [None] | [Range(<NRf> | MIN | MAX | DEF)]

Example: CONF:RES 10e3

Sets the range to 10k Ω .

CONFigure:FRESistance

Sets measurement to 4W Resistance on the first display and specifies range.

Parameter: [None] | [Range(<NRf> | MIN | MAX | DEF)]

Example: CONF:FRES 10e3

Sets the range to 10k Ω .

CONFigure:FREQuency

Sets measurement to Frequency on the first display and specifies the range.

Parameter: [None] | [Range(<NRf> | MIN | MAX | DEF)]

Example: CONF:FREQ MAX

Sets the frequency measurement range to max.

CONFigure:PERiod

Sets measurement to Period on the first display and specifies the range.

Parameter: [None] | [Range(<NRf> | MIN | MAX | DEF)]

Example: CONF:PER

Sets the DMM to period measurement using the autorange.

CONFigure:CONTInuity

Sets measurement to Continuity on the first display.

Parameter: None

CONFigure:DIODE

Sets measurement to Diode on the first display.

Parameter: None

CONFigure:TEMPerature:TCouple

Sets measurement to Temperature thermocouple on the first display.

Parameter: [None] | [Type(J | K | T)]

Example: CONF:TEMP:TCO J

Sets the measurement mode to TCO with a type J sensor.

CONFigure:CAPacitance

Sets measurement to Capacitance on the first display.

Parameter: [None] | [Range(<NRf> | MIN | MAX | DEF)]

Example: CONF:CAP 10E-6

Sets the measurement mode to Capacitance with a 10 μ F Range.

CONFigure:FUNCtion?

Returns the current function on the first display.

Return parameter: VOLT, VOLT:AC, VOLT:DCAC, CURR, CURR:AC, CURR:DCAC, RES, FRES, FREQ, PER, TEMP, DIOD, CONT, CAP

CONFigure:RANGe?

Returns the current range on the first display.

Return Parameter:

DCV: 0.1(100mV), 1(1V), 10(10V), 100(100V), 1000(1000V)

ACV: 0.1(100mV), 1(1V), 10(10V), 100(100V), 750(750V)

ACI: 0.01(10mA), 0.1(100mA), 1(1A), 10(10A)

DCI: 0.01(10mA), 0.1(100mA), 1(1A), 10(10A)

RES: 10E+1(100 Ω), 10E+2(1k Ω), 10E+3(10k Ω), 10E+4 (100k Ω), 10E+5(1M Ω), 10E+6(10M Ω), 10E+7(100M Ω)

FRES: 10E+1(100 Ω), 10E+2(1k Ω), 10E+3(10k Ω), 10E+4 (100k Ω), 10E+5(1M Ω), 10E+6(10M Ω), 10E+7(100M Ω)

CAP: 10E-9(10nF), 10E-8(100nF), 10E-7(1 μ F), 10E-6(10 μ F), 10E-5(100 μ F)

CONFigure:AUTO

Sets Auto-Range on or off on the first display.

Parameter: ON | OFF

Example: CONF:AUTO ON

CONFigure:AUTO?

Returns the Auto-Range status of the function on the 1st display.

Return Parameter: 0 | 1, 1=Auto range, 0=Manual range

Secondary Display: CONFigure2 Commands

CONFigure2:VOLTage:DC

Sets measurement to DC Voltage on the second display and specifies the range.

Parameter: [None] | [Range(<NRf> | MIN | MAX | DEF)]

Example: CONF2:VOLT:DC 1

Sets the voltage range to 1 volts.

CONFigure2:VOLTage:AC

Sets measurement to AC Voltage on the second display and specifies the range.

Parameter: [None] | [Range(<NRf> | MIN | MAX | DEF)]

Example: CONF2:VOLT:AC

Sets the measurement mode to AC voltage.

CONFigure2:CURREnt:DC

Sets measurement to DC Current on the second display and specifies the range.

Parameter: [None] | [Range(<NRf> | MIN | MAX | DEF)]

Example: CONF2:CURR:DC 10e-3

Sets the DC current range to 10mA on the second display.

CONFigure2:CURREnt:AC

Sets measurement to AC Current on the second display and specifies the range.

Parameter: [None] | [Range(<NRf> | MIN | MAX | DEF)]

Example: CONF2:CURR:AC 10e-2

Sets the measurement mode to ACI with a 100mA range on the second display.

CONFigure2:RESistance

Sets measurement to 2W Resistance on the second display and specifies the range.

Parameter: [None] | [Range(<NRf> | MIN | MAX | DEF)]

Example: CONF2:RES 10e3

Sets the range to 10k Ω on the second display.

CONFigure2:FRESistance

Sets measurement to 4W Resistance on the second display and specifies the range.

Parameter: [None] | [Range(<NRf> | MIN | MAX | DEF)]

Example: CONF2:FRES 10e3

Sets the range to 10k Ω on the second display.

CONFigure2:FREQuency

Sets measurement to Frequency on the second display and specifies the range.

Parameter: [None] | [Range(<NRf> | MIN | MAX | DEF)]

Example: CONF2:FREQ MAX

Sets the frequency measurement range to max on the second display.

CONFigure2:PERiod

Sets measurement to Period on the second display and specifies the range.

Parameter: [None] | [Range(<NRf> | MIN | MAX | DEF)]

Example: CONF2:PER

Sets the DMM to period measurement using the previous range on the second display.

CONFigure2:OFF

Turns the second display function off.

Parameter: None.

CONFigure2:FUNCTION?

Returns the current function on the second display.

Return parameter: VOLT, VOLT:AC, CURR, CURR:AC, RES, FRES, FREQ, PER, NON

CONFigure2:RANGE?

Returns the range of the current function on the second display.

Return parameter:

DCV: 0.1(100mV), 1(1V), 10(10V), 100(100V), 1000(1000V)

ACV: 0.1(100mV), 1(1V), 10(10V), 100(100V), 750(750V)

ACI: 0.01(10mA), 0.1(100mA), 1(1A), 10(10A)

DCI: 0.01(10mA), 0.1(100mA), 1(1A), 10(10A)

RES: 10E+1(100Ω) 10E+2(1kΩ), 10E+3(10kΩ), 10E+4 (100kΩ), 10E+5(1MΩ), 10E+6(10MΩ) , 10E+7(100MΩ)

FRES: 10E+1(100Ω) 10E+2(1kΩ), 10E+3(10kΩ), 10E+4 (100kΩ), 10E+5(1MΩ), 10E+6(10MΩ) , 10E+7(100MΩ)

CONFigure2:AUTO

Sets Auto-Range on or off on the 2nd display.

Parameter: ON | OFF

Example: CONF2:AUTO ON

CONFigure2:AUTO?

Returns the Auto-Range status of the function on the 2nd display.

Return Parameter: 0 | 1, 1=Auto range, 0=Manual range

Measure Commands

MEASure:VOLTage:DC?

Returns the DC voltage measurement on the first display.

Parameter: [None] | [Range(<NRf> | MIN | MAX | DEF)]

Example: MEAS:VOLT:DC?

> +0.10348E-01

Returns the DC voltage measurement as 0.010348 V.

MEASure:VOLTage:AC?

Returns the AC voltage measurement on the first display.

Parameter: [None] | [Range(<NRf> | MIN | MAX | DEF)]

Example: MEAS:VOLT:AC?

> +0.09020E-01

Returns the AC voltage measurement as 0.009020V.

MEASure:VOLTage:DCAC?

Returns the DC+AC voltage measurement on the first display.

Parameter: [None] | [Range(<NRf> | MIN | MAX | DEF)]

Example: MEAS:VOLT:DCAC?

> +0.10123E-01

Returns the DC+AC voltage measurement as 0.010123V.

MEASure:CURRent:DC?

Returns the DC current measurement on the first display.

Parameter: [None] | [Range(<NRf> | MIN | MAX | DEF)]

Example: MEAS:CURR:DC?

> +0.00703E-02

Returns the DC current measurement as 0.0703 mA.

MEASure:CURRent:AC?

Returns the AC current measurement on the first display.

Parameter: [None] | [Range(<NRf> | MIN | MAX | DEF)]

Example: MEAS:CURR:AC?

> +0.00872E-02

Returns the AC current measurement as 0.0872mA.

MEASure:CURRent:DCAC?

Returns the DC+AC current measurement on the first display.

Parameter: [None] | [Range(<NRf> | MIN | MAX | DEF)]

Example: MEAS:CURR:DCAC?

>+0.01245E-02

Returns the DC+AC current measurement as 0.1245 mA.

MEASure:RESistance?

Returns the 2W resistance measurement on the first display.

Parameter: [None] | [Range(<NRf> | MIN | MAX | DEF)]

Example: MEAS:RES?

> +1.00156E+03

Returns the 2W measurement as 1.00156k Ω .

MEASure:FRESistance?

Returns the 4W resistance measurement on the first display.

Parameter: [None] | [Range(<NRf> | MIN | MAX | DEF)]

Example: MEAS:FRES?

> +1.11365E+03

Returns the 4W measurement as 1.11365k Ω .

MEASure:FREQuency?

Returns the frequency measurement on the first display.

Parameter: [None] | [Range(<NRf> | MIN | MAX | DEF)]

Example: MEAS:FREQ?

> +1.00123E+03

Returns the frequency (1.00123kHz).

MEASure:PERiod?

Returns the period measurement on the first display.

Parameter: [None] | [Range(<NRf> | MIN | MAX | DEF)]

Example: MEAS:PER? MAX

Returns the period at the maximum range.

MEASure:CONTInuity?

Returns the continuity measurement on the first display.

Example: MEAS:CONT?

Returns the continuity.

MEASure:DIODe?

Returns the diode measurement on the first display.

Example: MEAS:DIOD?

Returns the diode measurement.

MEASure:CAPacitance?

Returns the capacitance measurement on the first display.

Example: MEAS:CAP?

Returns the capacitance measurement.

MEASure:TEMPerature:TCOuple?

Returns the temperature for the selected thermocouple type on the first display.

Parameter:[NONE] | J | K | T

Example: MEAS:TEMP:TCO? J

> +0.02667E+03

Returns the temperature measurement.

MEASure2:VOLTage:DC?

Returns the DC voltage measurement on the second display.

Parameter: [None] | [Range(<NRf> | MIN | MAX | DEF)]

Example: MEAS2:VOLT:DC?

>+0.10321E-01

Returns the DC voltage measurement as 0.010321V.

MEASure2:VOLTage:AC?

Returns the AC voltage measurement on the second display.

Parameter: [None] | [Range(<NRf> | MIN | MAX | DEF)]

Example: MEAS2:VOLT:AC?

>+0.10020E-01

Returns the AC voltage measurement as 0.010020V.

MEASure2:CURRent:DC?

Returns the DC current measurement on the second display.

Parameter: [None] | [Range(<NRf> | MIN | MAX | DEF)]

Example: MEAS2:CURR:DC?

>+0.00856E-02

Returns the DC current measurement as 0.0856 mA.

MEASure2:CURRent:AC?

Returns the AC current measurement on the second display.

Parameter: [None] | [Range(<NRf> | MIN | MAX | DEF)]

Example: MEAS2:CURR:AC?

> +0.01254E-02

Returns the AC current measurement as 0.1254mA.

MEASure2:RESistance?

Returns the 2W resistance measurement on the second display.

Parameter: [None] | [Range(<NRf> | MIN | MAX | DEF)]

Example: MEAS2:RES?

> +1.05203E+03

Returns the 2W measurement.

MEASure2:FRESistance?

Returns the 4W resistance measurement on the second display.

Parameter: [None] | [Range(<NRf> | MIN | MAX | DEF)]

Example: MEAS2:FRES?

> +1.00023E+03

Returns the 4W measurement.

MEASure2:FREQuency?

Returns the frequency measurement on the second display.

Parameter: [None] | [Range(<NRf> | MIN | MAX | DEF)]

Example: MEAS2:FREQ?

> +1.01122E+03

Returns the frequency (1.01122kHz).

MEASure2:PERiod?

Returns the period measurement on the second display.

Parameter: [None] | [Range(<NRf> | MIN | MAX | DEF)]

Example: MEAS2:PER? MAX

Returns the period at the maximum range.

SENSe Commands

[SENSe:]TEMPerature:TCouple:TYPE

Sets thermocouple type.

Parameter: Type(J | K | T)

Example: SENS:TEMP:TCO:TYPE J

Sets the thermocouple to type J.

[SENSe:]TEMPerature:TCouple:TYPE?

Returns the thermocouple type.

Return parameter: J, K, T

[SENSe:]TEMPerature:RJUNction:SIMulated

Set temperature simulation value.

Parameter: <NRf>(0.00 ~ 50.00)

Example: SENS:TEMP:RJUN:SIM 25.00

Sets the thermocouple junction temperature to 25°C.

[SENSe:]TEMPerature:RJUNction:SIMulated?

Returns temperature simulation value.

Return parameter: <NR1> (+0000~+5000) ,where +0000=0.00°C,
+5000=50.00°C

[SENSe:]DETEctor:RATE

Sets the detection rate (sample rate)

Parameter: RATE(S | M | F)

Example: SENS:DET:RATE S

Sets the rate to slow (S).

[SENSe:]DETEctor:RATE?

Returns the sample rate.

Return parameter: SLOW, MID, FAST

[SENSe:]AVERage:TCONtrol

Selects the digital filter.

Parameter: MOV | REP

Example: SENS:AVER:TCON MOV

Sets the digital filter to the moving filter.

[SENSe:]AVERage:TCONtrol?

Returns the current digital filter type.

Return parameter: MOV(moving), REP(repeating)

[SENSe:]AVERAge:COUNT

Sets the digital filter average count.

Parameter: <NR1> (2~320) | MIN | MAX

Example: SENS:AVER:COUN 100

Sets the digital filter average count to 100.

[SENSe:]AVERAge:COUNT?

Returns the current digital filter average count.

Return parameter: <NR1>(+002 ~ +320)

[SENSe:]AVERAge:WINDow

Sets the digital filter window.

Parameter: 0.01 | 0.1 | 1 | 10 | 0 (none)

Example: SENS:AVER:WIND 0.1

Sets the digital filter window to 0.1%.

[SENSe:]AVERAge:WINDow?

Returns the current digital filter window value.

Return parameter: 0.01, 0.1, 1, 10, NONE

[SENSe:]AVERAge:STATe

Turns the digital filter on or off.

Parameter: ON | OFF

Example: SENS:AVER:STAT ON

Turns the digital filter on.

[SENSe:]AVERAge:STATe?

Returns the state of the digital filter (on or off).

Return parameter: 0 | 1, 0=OFF, 1=ON

[SENSe:]FREQuency:INPutjack

Assigns an input terminal for the frequency function.

Parameter: (0 | 1 | 2) 0=volt, 1=1A, 2=10A

Example: SENS:FREQ:INP 0

Sets the input jack to the Volt input terminal.

[SENSe:]FREQuency:INPutjack?

Returns the assigned input terminal used for the frequency function.

Return Parameter: VOLT, 1A, 10A

[SENSe:]PERiod:INPutjack

Assigns an input terminal for the period function.

Parameter: (0 | 1 | 2) 0=volt, 1=1A, 2=10A

Example: SENS:PER:INP 0

Sets the input jack to the Volt input terminal.

[SENSe:]PERiod:INPutjack?

Returns the assigned input terminal used for the period function.

Return Parameter: VOLT, 1A, 10A

[SENSe:]CONTInuity:THReshold

Sets the continuity threshold in ohms.

Parameter: <NRf> (0 ~ 1000)

Example: SENS:CONT:THR 500

Sets the continuity threshold to 500 ohms.

[SENSe:]CONTInuity:THReshold?

Returns the continuity threshold.

Return Parameter: <NR1> (0~1000)

[SENSe:]UNIT

Sets the temperature unit.

Parameter: C|F

Example: SENS:UNIT C

Sets the temperature unit to °C.

[SENSe:]UNIT?

Returns the temperature unit.

[SENSe:]FUNCTION[1/2]

Sets the function for the first or second display.

Parameter:

(display1): "VOLT[:DC]", "VOLT:AC", "VOLT:DCAC",
 "CURR[:DC]", "CURR:AC", "CURR:DCAC", "RES", "FRES",
 "FREQ", "PER", "TEMP:TCO", "DIOD", "CONT", "CAP"

(display2): "VOLT[:DC]", "VOLT:AC", "CURR[:DC]",
 "CURR:AC", "RES", "FRES", "FREQ", "PER", "NON"

Example: SENS:FUNC1 "VOLT:DC"

Sets the 1st display to the DCV function.

[SENSe:]FUNCTION[1/2]?

Returns the function displayed on the first or second display.

Return parameter:

(display 1): VOLT, VOLT:AC, VOLT:DCAC, CURR,
 CURR:AC, CURR:DCAC, RES, FRES, FREQ, PER, TEMP:TCO,
 DIOD, CONT, CAP

(display 2): VOLT, VOLT:AC, CURR, CURR:AC, RES, FRES,
 FREQ, PER, NON

CALCulate Commands

CALCulate:FUNCtion

Sets the Advanced function.

Parameter: OFF | MIN | MAX | HOLD | REL | COMP | DB |
DBM | MXB | INV | REF

Example: CALC:FUNC REL

Sets the Advanced function to REL (relative)

CALCulate:FUNCtion?

Returns the current Advanced function.

CALCulate:STATe

Turns the Advanced function on/off.

Parameter: ON | OFF

Example: CALC:STAT OFF

Turns the Advanced function off.

CALCulate:STATe?

Returns the status of the Advanced function.

Return Parameter: 0 | 1, 1=ON, 0=OFF

CALCulate:MINimum?

Returns the minimum value from the Max/Min measurement.

CALCulate:MAXimum?

Returns the maximum value from the Max/Min measurement.

CALCulate:HOLD:REFeRence

Sets the percentage threshold for the Hold function.

Parameter: <NRf> (0.01, 0.1, 1, 10)

Example: CALC:HOLD:REF 10

Sets the hold percentage to 10%.

CALCulate:HOLD:REFeRence?

Returns the percentage threshold from the Hold function.

CALCulate:REL:REFeRence

Sets the reference value for the relative function.

Parameter: <NRf> | MIN | MAX

Example: CALC:REL:REF MAX

Sets the reference value to the maximum allowed.

CALCulate:REL:REFeRence?

Returns the reference value from the relative function.

CALCulate:LIMit:LOWer

Sets the lower limit of the compare function.

Parameter: <NRf> | MIN | MAX

Example: CALC:LIM:LOW 1.0

Sets the lower limit to 1.0

CALCulate:LIMit:LOWer?

Returns the lower limit of the compare function.

CALCulate:LIMit:UPPer

Sets the upper limit of the compare function.

Parameter: <NRf> | MIN | MAX

Example: CALC:LIM:UPP 1.0

Sets the upper limit to 1.0

CALCulate:LIMit:UPPer?

Returns the upper limit of the compare function.

CALCulate:DB:REFerence

Sets the reference value for the dB function.

Parameter: <NRf> | MIN | MAX

Example: CALC:DB:REF MAX

Sets the reference voltage for dB measurements to the maximum allowed.

CALCulate:DB:REFerence?

Returns the reference voltage from the dB function.

CALCulate:DBM:REFerence

Sets the resistance value for the dBm function.

Parameter: <NRf> | MIN | MAX

Example: CALC:DBM:REF MAX

Sets the resistance value for dBm measurements to the maximum allowed.

CALCulate:DBM:REFerence?

Returns the resistance value from the dBm function.

CALCulate:MATH:MMFactor

Sets the scale factor M for math measurements.

Parameter: <NRf> | MIN | MAX

Example: CALC:MATH:MMF MIN

Sets the scale factor M to the minimum allowed value.

CALCulate:MATH:MMFactor?

Returns the scale factor M used in the math measurement.

CALCulate:MATH:MBFactor

Sets the offset factor B for math measurements.

Parameter: <NRf> | MIN | MAX

Example: CALC:MATH:MBF MIN

Sets the offset factor B to the minimum allowed value.

CALCulate:MATH:MBFactor?

Returns the offset factor B used in the math measurement.

CALCulate:MATH:PERCent

Sets the reference value for the Percent function.

Parameter: <NRf> | MIN | MAX

Example: CALC:MATH:PERC MAX

Sets the reference value for the Percent function to the maximum.

CALCulate:MATH:PERCent?

Returns the reference value setting for the Percent function.

TRIGger Commands

READ?

Returns 1st and 2nd display value.

Example1:

```
SAMP:COUN 4(USBTMC)
READ?(count = SAMP:COUN/2, rounded up)
>+0.10212E-01,+0.00000E+00,+0.10348E-01,+0.00000E+00
Queries 2 counts of measurement samples from the first and
second display.
```

Example2:

```
SAMP:COUN 3(USBCDC or RS232)
READ?(Count = 3)
>+0.10212E-01,+0.00000E+00,+0.10348E-01,+0.00000E+00,
+0.10123E-01, +0.00000E+00
Queries 3 counts of measurement samples from the first and
second display.
```

VAL1?

Returns the 1st display reading

Example: SAMP:COUN 3 (all remote interfaces)

```
VAL1?
>+0.10212E-01,+0.10348E-01, +0.10123E-01
Queries 3 counts of measurement samples from the 1st display.
```

VAL2?

Returns the 2nd display reading.

Example: SAMP:COUN 3 (all remote interfaces)

```
VAL2?
>+0.10212E-01,+0.10348E-01, +0.10123E-01
Queries 3 counts of measurement samples from the 2nd display.
```

TRIGger:SOURce

Selects the trigger source.

Parameter: INT | EXT

Example: TRIG:SOUR INT

Sets the trigger source as internal.

TRIGger:SOURce?

Returns current trigger source.

TRIGger:AUTO

Turns Trigger Auto mode on/off.

Parameters: ON | OFF

Example: TRIG:AUTO OFF

Turns the Trigger Auto mode off.

TRIGger:AUTO?

Returns the Trigger Auto mode.

Return parameter: 0 | 1, 0=OFF, 1=ON

SAMPle:COUNt

Sets the number of samples.

Parameter: <NR1>(CDC:1 ~ 9999 | TMC:1 ~ 320) | MIN | MAX

Example: SAMP:COUN 10

Sets the number of samples to 10.

SAMPle:COUNt?

Returns the number of samples.

Parameter: None | MIN | MAX

TRIGger:COUNT

Sets the number of trigger counts.

Parameter: <NR1>(1 ~ 9999) | MIN | MAX

Example: TRIG:COUN 10

Sets the number of trigger counts to 10.

TRIGger:COUNT?

Returns the number of trigger counts.

Parameter: None | MIN | MAX

SYSTEM Related Commands

SYSTEM:BEEPer:STATe

Selects the beeper mode; no beep, beep on fail and beep on pass.

Parameter: <NR1>(0 | 1 | 2) 0=no beep, 2=fail, 1=pass

Example: SYST:BEEP:STAT 0

Turns the beeper off.

SYSTEM:BEEPer:STATe?

Returns the beeper mode.

Return parameter: Beep on Pass | Beep on Fail | No Beep

SYSTEM:BEEPer:ERRor

Sets the beeper to sound on an SCPI error.

Parameter: ON | OFF

Example: SYST:BEEP:ERR ON

Allows the beeper to sound when an SCPI error occurs.

SYSTEM:BEEPer:ERRor?

Returns the beeper error mode.

Return parameter: 0 | 1, 0=OFF, 1=ON

SYSTEM:BEEPer

Issues a single beep.

Parameter: NONE

SYSTEM:ERRor?

Returns the current system error, if any.

SYSTEM:VERSion?

Returns system version.

Return Parameter: X.XX.

SYSTem:DISPlay

Turns the Display on/off.

Parameter: ON | OFF

Example: SYST:DISP ON

Turns the display on.

SYSTem:DISPlay?

Returns the status of the display

Return parameter: 0 | 1, 0=OFF, 1=ON

SYSTem:SERial?

Returns the serial number (nine characters/numbers)

INPut:IMPedance:AUTO

Sets the input impedance for DCV mode (100mV range and 1V range).

Parameter: ON(10G) | OFF(10M)

Example: INP:IMP:AUTO ON

Turns the Automatic input impedance on.

INPut:IMPedance:AUTO?

Returns the input impedance mode.

Return parameter: <Boolean>(0 | 1) (0=OFF(10M), 1=ON(10G))

DISPlay:TEXT

Write a message to the display.

Parameter: Text can contain alphanumeric characters including spaces, '+', '-', '/', up to 13 characters.

Example: DISP:TEXT "DMM TEST"

Write "DMM TEST" to the display.

DISPlay:TEXT?

Returns the displayed message.

DISPlay:TEXT:CLEAr

Clear message from display.

Parameter: NONE

Example: DISP:TEXT:CLE

DIGitalio:MODE

Sets the mode for Digital I/O.

Parameter: NORM | USER

Example: DIG:MODE NORM

Sets the Digital I/O Mode to normal.

DIGitalio:MODE?

Returns the Digital I/O mode.

Return parameter: NORM | USER

DIGitalio[1|2|3|4]:SETup

Sets the status for Digital I/O(only for user mode).

Parameter: ON | OFF

Example: DIG1:SET ON

DIGitalio[1|2|3|4]:SETup?

Returns the Digital I/O status (only for User mode).

Return parameter: 0 | 1, 0=OFF, 1=ON

STATus Report Commands

STATus:QUESTionable:ENABLE

Set bits in the Questionable Data Enable register.

STATus:QUESTionable:ENABLE?

Returns the contents of the Questionable Data Enable register.

STATus:QUESTionable:EVENT?

Returns the contents of the Questionable Data Event register.

STATus:PRESet

Clears the Questionable Data Enable register.

Example: STAT:PRES

Interface Commands

SYSTem:LOCal

Enables local control (front panel control) and disables remote control.

SYSTem:REMote

Enables remote control and disables local control (front panel control). Local control can be recalled by pressing the 2ND or local button.

SYSTem:RWLock

Enables remote control and disables local control (front panel control). Once this command has been issued, pressing the 2ND or local buttons will not return the user to local control. The only way to return to local mode is to issue the SYSTem:LOCAl command.

IEEE 488.2 Common Commands

***CLS**

Clears the Event Status register (Output Queue, Operation Event Status, Questionable Event Status, Standard Event Status)

***ESE?**

Returns the ESER (Event Status Enable Register) contents.

Example: *ESE?

>130

Returns 130. ESER=10000010

***ESE**

Sets the ESER contents.

Parameter: <NR1> (0~255)

Example: *ESE 65

Sets the ESER to 01000001

***ESR?**

Returns SESR (Standard Event Status Register) contents.

Example: *ESR?

>198

Returns 198. SESR=11000110

*IDN?

Returns the manufacturer, model No., serial number and system version number.

Example: *IDN?

>GWInstek,GDM8351,00000000,1.0

*OPC?

"1" is placed in the output queue when all the pending operations are completed.

*OPC

Sets the operation complete bit (bit0) in SERS (Standard Event Status Register) when all pending operations are completed.

*PSC?

Returns power On clear status.

Return parameter: <Boolean>(0 | 1) 0= don't clear, 1=clear

*PSC

Clears power On status.

Parameter: <Boolean>(0 | 1) 0=don't clear, 1= clear

*RST

Recalls default panel setup.

*SRE?

Returns the SRER (Service Request Enable Register) contents.

*SRE

Sets SRER contents.

Parameter: <NR1>(0~255)

Example: *SRE 7

Sets the SRER to 00000111.

*STB?

Returns the SBR (Status Byte Register) contents.

Example:*STB?

>64

Returns the contents of the SBR as 01000000.

*TRG

Manually triggers the DMM.

For the following command sets, please refer to the status system diagram on page 144.

STAT: QUES: EVEN?

STAT: QUES: ENAB

STAT: QUES: ENAB?

*ESR?

*ESE

*ESE?

*STB?

*SRE

*SRE?

FAQ

The DMM performance doesn't match the specifications.

Make sure the device is powered On for at least 30 minutes, within 18~28°C. This is necessary to stabilize the unit to match the specifications.

The measured voltage does not match the expected value.

There are a number of reasons why the measured value may not match the expected values.

1. Ensure that all connections are connected securely and have a good contact at all times. Poor contacts could result in erroneous measurements.
2. Ensure that the appropriate input resistance has been set in the System menu. For 100mv and 1V ranges, the input resistance can be set to either 10MΩ or 10GΩ.
3. When measuring AC voltage or current, the RMS of the voltage peak is measured, not the voltage peak. See page 35 for details.
4. The measurement rate settings can have an effect on the accuracy of the measurement. Slow measurements are more accurate, while the fast rate is not as accurate.
5. Ensure that an appropriate range setting is used. If a too-large range is used, the resolution or the measurement may be affected.

For more information, contact your local dealer or GWInstek at www.gwinstek.com / marketing@goodwill.com.tw.

APPENDIX

System Menu Tree

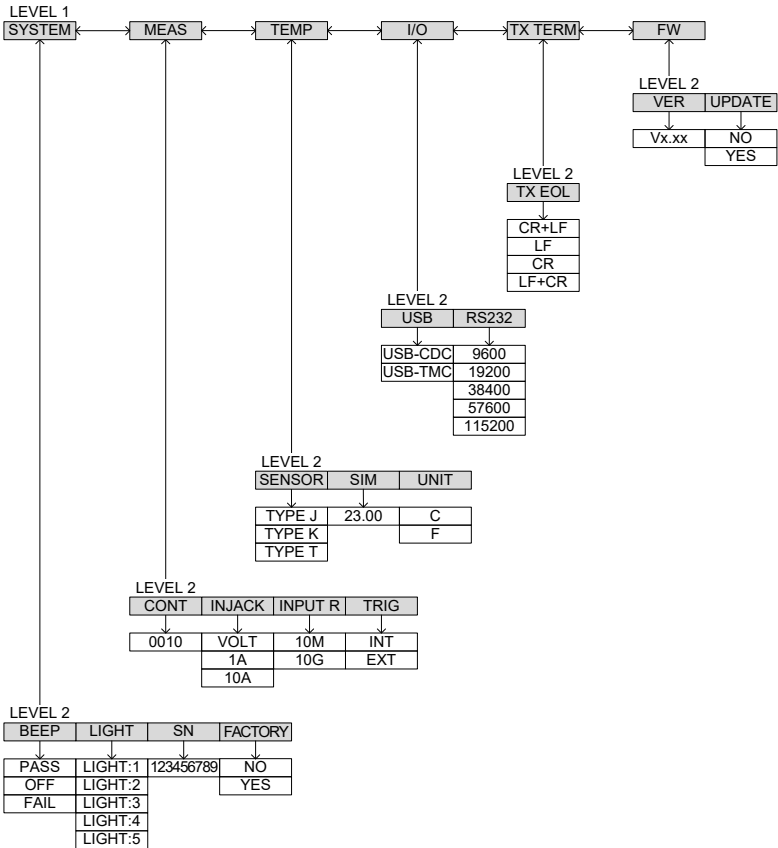

Factory Default Settings

Measurement Item	DCV
Range	AUTO
Rate	S
SYSTEM Menu	BEEP: Pass LIGHT: 3 S/N: N/A FACTORY: NO
MEAS Menu	CONT: 0010 Ω INJACK: VOLT INPUT R: 10M
TEMP Menu	SENSOR: TYPE J SIM: 23.00 UNIT: C
I/O Menu	USB: USB-CDC
TX Term	EOL:CR+LF
FW	N/A

Replacing the AC Source Fuse

Fuse Ratings	Type	Rating	Size
	0.125AT	100VAC, 120VAC	5mm X 20mm
	0.063AT	220VAC, 240VAC	5mm X 20mm



Note

Only replace the fuse with a fuse of the correct type and rating.

Steps

1. Turn the DMM off and take out the power cord.
2. Remove the fuse socket using a flathead screwdriver.

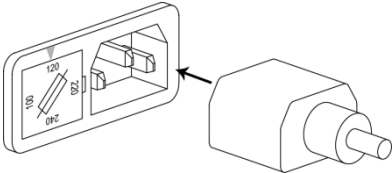

3. Remove the fuse in the holder and replace with the correct type and rating.

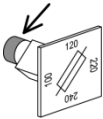

4. Ensure the correct line voltage is lined up with the arrow on the fuse holder. Insert the fuse socket.

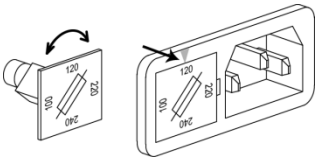

Replacing the Input Fuse

Fuse Rating	Type	Rating	Size
	F1.25A	1.25A 1000V	6.3mm X 32mm



Note

Only replace the fuse with a fuse of the correct type and rating.

- Steps
1. Turn the DMM off.
 2. Press the fuse holder with your finger and turn anticlockwise. This will release the fuse holder from the panel.

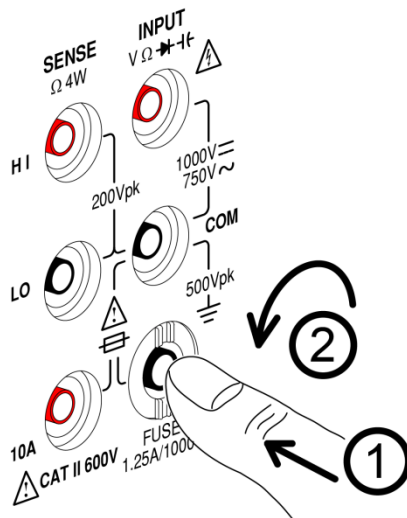

3. Replace the fuse at the end of the holder with the correct type and rating.

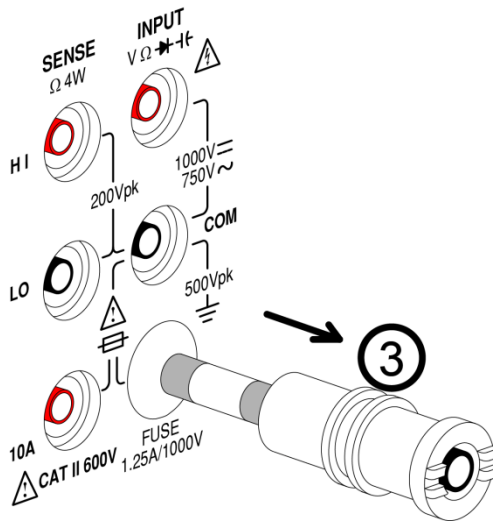

4. Push the fuse holder back into the panel and turn clockwise when the fuse holder is level with the front panel.

Status system

The diagram below is a description of the status system

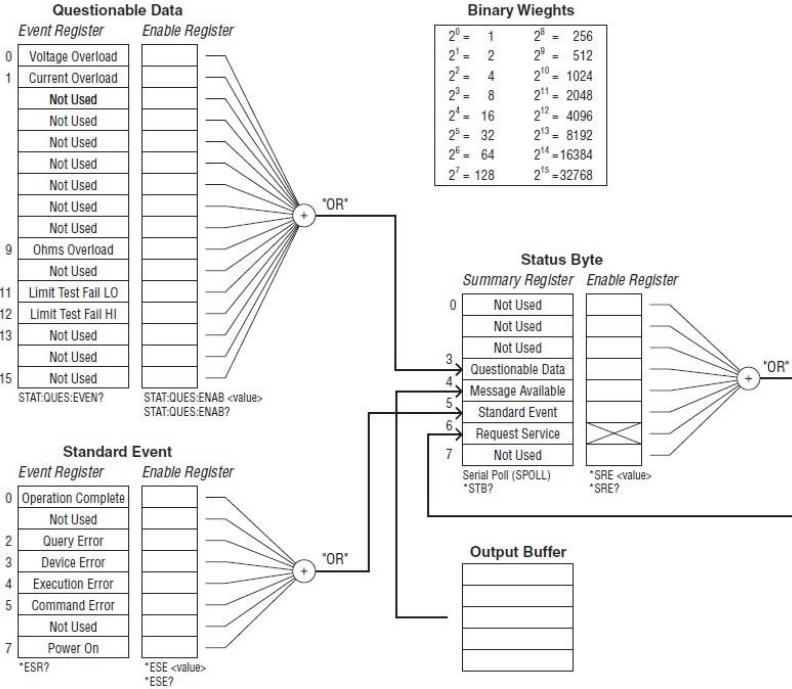

For the following command sets, please refer to the diagram above.

STAT: QUES: EVEN?

STAT: QUES: ENAB

STAT: QUES: ENAB?

*ESR?

*ESE

*ESE?

*STB?

*SRE

*SRE?

Specifications

The specifications apply when the DMM is warmed up for at least 30 minutes and operates in the slow rate.

Below are the basic conditions required to operate the DMM within specifications:

- Calibration: Yearly
- Accuracy: \pm (% of Reading + Digits)
- The power supply cable must be grounded to ensure accuracy.
- All specifications are applicable to the main (1st) display only.

General Specifications

Specification Conditions:

Temperature: 23 °C \pm 5 °C

Humidity: <80%RH, 75%RH for resistance measurement readings greater than 10M Ω

Operating Environment: (0~50 °C)

Temperature Range: 0~35 °C, Relative Humidity: <90%RH;
>35 °C, Relative Humidity: <80%RH

Indoor use only

Altitude: 2000 meters

Pollution degree 2

Storage Conditions (-40~70 °C)

Temperature Range: 0~35 °C, Relative Humidity: <90%RH;
>35 °C, Relative Humidity: <80%RH

General:

Power Consumption: Max 15VA

Dimensions: 107mm(H) X 264.4mm(D) X 300.2mm(L) (with bumpers)
88mm(H) X 228mm(D) X 276mm(L) (without bumpers)

Weight: Approximately 2.9 kg

DC Voltage

Range ^[1]	Resolution	Full Scale	Accuracy
100.000mV	0.001mV	120.000	0.012% + 8
1.00000 V	0.00001V	1.20000	0.012% + 5
10.0000 V	0.0001V	12.0000	0.012% + 5
100.000 V	0.001V	120.000	0.012% + 5
1000.00 V ^[2]	0.01 V	1020.00	0.012% + 5

[1] When the input value exceeds the full scale of the selected range, the display will show -OL- (over load) on the display.

[2] The specifications are guaranteed to an input voltage of 1000V. A beeping alarm will go off when the input voltage is higher than 1000V.

DC Current

Range ^[1]	Resolution	full scale	Accuracy
10.0000mA	0.0001mA	12.0000	0.05% + 5
100.000mA	0.001mA	120.000	0.05% + 5
1.00000A	0.00001 A	1.20000	0.2% + 5
10.0000A ^[2]	0.0001 A	12.0000	0.2% + 5

[1] When the input value exceeds the full scale of the selected range, the display will show -OL- (over load) on the display.

[2]The specifications are guaranteed to an input of 10A. A beeping alarm will go off when the input value is higher than 10A.

Diode

Test voltage	Resolution	Maximum reading	Accuracy
6V	0.0001 V	5.9999V	0.012% + 5

* The diode test voltage is 6V, 1mA.

Continuity

Range	Resolution	Maximum reading	Accuracy
1000.00Ω	0.01Ω	1200.00	0.1% + 8

* Without REL function, add 0.2 Ω additional error.

Resistance ^[1] ^[2]

Range	Resolution	full scale	Current source	Accuracy (4W)
100.000Ω	0.001Ω	120.000	1mA	0.05% + 8
1.00000KΩ	0.00001KΩ	1.20000	1 mA	0.05% + 5
10.0000KΩ	0.0001KΩ	12.0000	100μA	0.05% + 5
100.000KΩ	0.001KΩ	120.000	10μA	0.05% + 5
1.00000MΩ	0.00001MΩ	1.20000	1μA	0.05% + 5
10.0000MΩ	0.0001MΩ	12.0000	0.5μA	0.3% + 5
100.000MΩ	0.001MΩ	120.000	0.5μA//10M	3.0% + 8

[1] Specifications are for 4-wire resistance measurement, or 2-wire resistance measurement using the REL function. Without the REL function, add 0.2 Ω additional error when using 2-wire resistance measurement.

[2] When measuring resistances greater than 500kΩ, please use shielded test leads to eliminate the noise interference that may be induced by standard test leads.

AC Voltage ^[1] ^[2]

Range	Resolution	Full Scale	20 Hz to 45 Hz	45 Hz to 10kHz	10 kHz to 30 kHz	30 kHz to 100 kHz
100.000mV	0.001mV	120.000	1% + 100	0.3% + 100	1.5% + 300	5% + 300
1.00000 V	0.00001V	1.20000	1% + 100	0.2% + 100	1% + 100	3% + 200
10.0000 V	0.0001V	12.0000	1% + 100	0.2% + 100	1% + 100	3% + 200
100.000 V	0.001V	120.000	1% + 100	0.2% + 100	1% + 100	3% + 200
750.00 V ^[3]	0.01V	765.00	1% + 100	0.2% + 100	1% + 100	3% + 200

[1] Specifications are for sine wave inputs that are greater than 5% range.

[2] Rate in Fast, Input ACV Frequency > 200Hz.

[3] The specifications are guaranteed to an input of 750V. A beeping alarm will go off when the input value is higher than 750V.

AC Current

Range ^{[1][3]}	Resolution	Full Scale	Accuracy		
			20 Hz to 45 Hz	45 Hz to 2 kHz	2 kHz to 10kHz
10.0000mA	0.0001mA	12.0000	1.5% + 100	0.5% + 100	2% + 200
100.000mA	0.001mA	120.000	1.5% + 100	0.5% + 100	2% + 200
1.00000A	0.00001A	1.20000	1.5% + 100	0.5% + 100	2% + 200 ^[2]
10.0000A ^[4]	0.0001A	12.0000	1.5% + 100	1% + 100	-

[1] Specifications are for sine wave inputs that are greater than 5% of range.

[2] Input current (5k ~ 10kHz)<220mArms.

[3] The accuracy of ACI+DCI is equal to ACI's with 10 more digits added.

[4] The specifications are guaranteed to 10A. A beeping alarm will go off when the input current being measured is higher than 10A.

Frequency Accuracy

Rate	10Hz to 1MHz ^[1]
Slow (>10Hz)	
Med (>20Hz)	0.01% + 3
Fast (>200Hz)	

[1] 750Vac range limited to 100kHz or 8x10⁷ Volt-Hz on other ranges.

Voltage Measurement Sensitivity

Range	10 Hz to 100kHz	100kHz to 1MHz
100mV	40 mVrms	0.3Vrms
1V	At least 5% of voltage range	1Vrms
10V ~ 750V	At least 5% of voltage range	At least 5% of voltage range

Current Measurement Sensitivity

Range	20 ~ 10kHz
10mA ~ 10A	At least 5% of current range

Thermocouple Specifications

Type	Measurement Range	Resolution	Accuracy (-200 ~ 0°C)	Accuracy (0 ~ 300°C)
J, K, T	-200 ~ +300°C	0.01°C	0.4°C	0.2°C

*Specifications do not include probe accuracy.

Capacitance

Range	Resolution	Full Scale	Test Current	Accuracy
10.00nF ^[1]	0.01nF	12.00	10μA	2.0%+10
100.0nF	0.1nF	120.0	10μA	2.0%+4
1.000μF	0.001μF	1.200	100μA	2.0%+4
10.00μF	0.01μF	12.00	1mA	2.0%+4
100.0μF	0.1μF	120.0	1mA	2.0%+4

*Specifications are for film Capacitance inputs that are greater than 10% range.

[1] 10nF capacitance measurements may be affected by the stray capacitance on the test cables. Before testing, use the REL function to compensate for the stray capacitance from the test cables.

Additional Specifications

The Additional Specifications apply in addition to the Specifications listed on page 145 when the operating temperature exceeds 18°C ~ 28°C.

DC Voltage

Measurement method: Sigma Delta A-to-D converter.

Input protection: 1000V peak on all ranges.

Range	Typical Input Impedance
100mV/1V	10.0 MΩ±2% or >10GΩ
10 V	11.1 MΩ±2%
100 V	10.1 MΩ±2%
1000 V	10.0 MΩ±2%

Rate	Additional Rate Error Count
Med	50
Fast	200

DC Current

* 10mA~1A range has a 3V voltage limit protection and F1.25A/1000V fuse protection.

And 10A range has a F12A/600V fuse protection.

Shunt resistance

Range	Shunt	Burden voltage
10mA	1Ω	< 0.15V
100mA	1Ω	< 1.5V
1A	0.1Ω	< 0.8V
10A	0.01Ω	< 0.6V

Rate	Additional Rate Error Count
Med	60
Fast	200

AC Voltage (AC Coupling Mode/AC + DC Coupling Mode)

Measurement method: AC coupled true RMS - measure the AC component with up to 400 VDC bias on any range.

Crest Factor: Maximum 3 at full scale.

Input Impedance: 1 MΩ ± 2% in parallel with <100 pF on all ranges.

Maximum input voltage: 750 Vrms on all ranges.

Input protection: 1200V peak on all ranges with gas discharge.

Rate	[1] Frequency
Med	>20Hz
Fast	>200Hz

Rate	Range	Accuracy			
		20 Hz to 45 Hz	45 Hz to 10 kHz	10 kHz to 30 kHz	30 kHz to 100 kHz
Med	100.000mV	1% + 200	0.3% + 400	1.5% + 800	5% + 1200
	1.00000 V	1% + 200	0.2% + 400	1% + 400	3% + 800
	10.0000 V	1% + 200	0.2% + 400	1% + 400	3% + 800
	100.000 V	1% + 200	0.2% + 400	1% + 400	3% + 800
	750.00 V	1% + 200	0.2% + 400	1% + 400	3% + 800
Fast	100.000mV	-	0.3% + 1000	1.5% + 1000	5% + 1500
	1.00000 V	-	0.2% + 500	1% + 500	3% + 1000
	10.0000 V	-	0.2% + 500	1% + 500	3% + 1000
	100.000 V	-	0.2% + 500	1% + 500	3% + 1000
	750.00 V	-	0.2% + 500	1% + 500	3% + 1000

*The accuracy of ACV+DCV is equal to ACV's with 10 more digits added.

[1] The accuracy of the AC voltage measurement is guaranteed only when the signal being measured has frequencies higher than what is listed here.

AC Current (AC Coupling Mode/AC + DC Coupling Mode)

Measurement method: Current to the fuse and current shunt, AC coupled true RMS measurement (measures the AC component only).

Crest factor: Maximum of 3 at full scale.

Rate	Range	Accuracy		
		20 Hz to 45 Hz	45 Hz to 2 kHz	2 kHz to 10KHz
Med	10.0000mA	1.5% + 400	0.5% + 400	2% + 800
	100.000mA	1.5% + 120	0.5% + 120	2% + 300
	1.00000A	1.5% + 120	0.5% + 120	2% + 300
	10.0000A	2% + 120	1% + 120	-
Fast	10.0000mA	-	0.5% + 500	2% + 1000
	100.000mA	-	0.5% + 200	2% + 500
	1.00000A	-	0.5% + 200	2% + 500
	10.0000A	-	1% + 200	-

Rate	Additional Rate Error Count
Med	50
Fast	500

Shunt resistance

Range	SHUNT	Burden voltage
10mA	1Ω	< 0.15V
100mA	1Ω	< 1.5V
1A	0.1Ω	< 0.8V
10A	0.01Ω	< 0.6V

Resistance (2-wire resistance and 4-wire resistance)

Measurement method: 2-wire resistance or 4-wire resistance.

Open-circuit voltage: Approximately 7.5 VDC.

Input protection: 500V_{peak} on all ranges.

Diode

Measurement method: 1mA \pm 2% constant current source.

Open-circuit voltage: Approximately 7.5 VDC.

Input protection: Input protection of 500V peak.

Rate	Additional Rate Error Count
Med	50
Fast	200

Continuity

Measurement method: 1mA \pm 2% constant current source.

Open-circuit voltage: Approximately 7.5 VDC.

Input protection: Input protection of 500V peak.

Continuity threshold: 0 Ω ~ 1000 Ω .

Threshold step: 1 Ω .

Rate	Additional Rate Error Count
Med	60
Fast	200

Frequency

Measurement method: Reciprocal counting technique.

Input impedance: $1\text{M}\Omega \pm 2\%$ in parallel with $<100\text{pF}$ on all ranges.

Maximum input voltage: 750 Vrms on all ranges.

Input protection: 1200V peak on all ranges with gas discharge.

Refresh Rate	Gate Time(sec)
Slow	1
Med	0.1
Fast	0.01

Capacitance

Measurement method: DC recharge & discharge.

Input protection: 500 Vpeak on all ranges.

The capacitor under test (C_x) is charged using a constant current source. The time to charge C_x is recorded. The capacitor is then discharged using a known resistance and the discharge time is recorded. The value of the resistance depends on the capacitance range that is selected. The charge and discharge time is used to calculate the capacitance of C_x if the selected capacitance range is equal to or less than 10nF. Only the charge time is used to calculate the capacitance of C_x if the selected capacitance range is equal to or greater than 100nF.

As measuring capacitance with the DMM is effectively a DC measurement, the measured capacitance tends to be higher than what is measured by LCR meters.

For best measurement results, first perform a zeroing of the test leads when the cables are “open” to compensate for the test lead capacitance.

Measurement Noise Rejection

DC Common mode reject ratio (DC CMRR): For 1 k Ω unbalanced LO lead, 50/60 Hz \pm 0.1%: DC > 90 dB.

Temperature Coefficients

Specified ambient temperature range accuracy is typically within the calibration temperature (Tcal) \pm 5°C range. If the operating environment of the multimeter is within 0°C to (Tcal)-5°C or (Tcal)+5°C to 50°C (specification units/°C), you must add the additional temperature coefficient errors to the accuracy specifications.

Temperature Coefficient = add \pm 0.15 x [the applicable accuracy)/°C].

Dimensions

GDM-8351

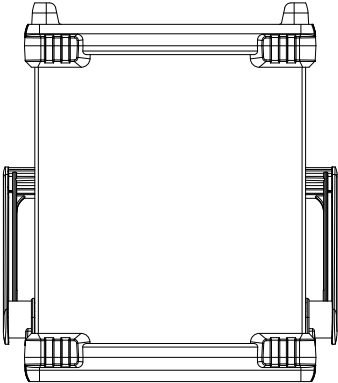

Units = mm.

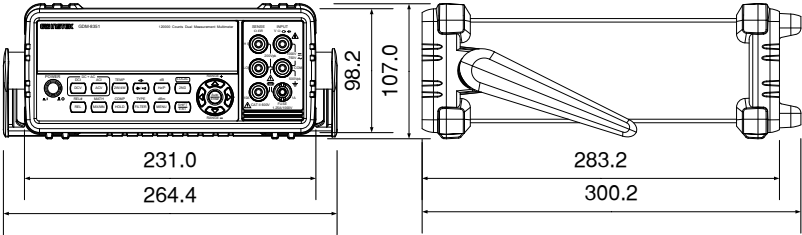

107mm(H) X 264.4mm(D) X 300.2mm(L) (with bumpers)
88mm(H) X 228mm(D) X 276mm(L) (without bumpers)

Declaration of Conformity

We

GOOD WILL INSTRUMENT CO., LTD.

No. 7-1, Jhongsing Rd, Tucheng Dist., New Taipei City 236, Taiwan

GOOD WILL INSTRUMENT (SUZHOU) CO., LTD.

No. 69 Lushan Road, Suzhou New District Jiangsu, China.

declare that the below mentioned product

Type of Product: Digital Multimeter

Model Number: GDM-8351

are herewith confirmed to comply with the requirements set out in the Council Directive on the Approximation of the Law of Member States relating to Electromagnetic Compatibility (2004/108/EC) and Low Voltage Directive (2006/95/EC).

For the evaluation regarding the Electromagnetic Compatibility and Low Voltage Directive, the following standards were applied:

© EMC	
EN 61326-1: EN 61326-2-1:	Electrical equipment for measurement, control and laboratory use -- EMC requirements (2013)
Conducted & Radiated Emission EN 55011: 2009+A1:2010	Electrostatic Discharge EN 61000-4-2: 2009
Current Harmonics EN 61000-3-2: 2006+A1: 2009+A2: 2009	Radiated Immunity EN 61000-4-3: 2006+A1:2008+A2:2010
Voltage Fluctuations EN 61000-3-3:2013	Electrical Fast Transients IEC 61000-4-4: 2012
-----	Surge Immunity EN 61000-4-5: 2006
-----	Conducted Susceptibility EN 61000-4-6: 2009
-----	Power Frequency Magnetic Field EN 61000-4-8: 2010
-----	Voltage Dip/ Interruption EN 61000-4-11: 2004

Low Voltage Equipment Directive 2006/95/EC	
Safety Requirements	EN 61010-1: 2010 EN 61010-2-030: 2010

INDEX

Accessories	12	setting	48
Advanced measurement		Conventions	25
compare.....	70	Current	
dB	65	range.....	39
dBm/ dB calculation.....	63	setting	37
dBm/W	63	Declaration of conformity	157
Digital filter settings.....	83	Digital I/O.....	88
hold	69	Normal mode	90
Math		Overview	89
1/X	73	User mode.....	91
Digital filter overview	81	Diode	
MX+B.....	72	setting	45
overview.....	72	Display overview	19
max/min	66	Disposal instructions.....	8
overview	62	Dual measurement	
Percentage.....	74	modes	57
relative.....	67	overview	57
supported functions	62	EN61010	
Brightness level.....	78	measurement category	6
Cancel remote control.....	98	pollution degree	8
Capacitance		Environment	
range	47	safety instruction	7
setting	46	Factory default settings	
Caution symbol.....	5	restore.....	85
Cleaning the instrument.....	7	Factory default settings.....	140
Command IEE488.2 commands.....	135	Frequency	
Command set		setting	51
CALCulate commands	124	Frequency/Period input jack	
CONFigure commands	108	settings.....	80
CONFigure2 commands	112	Front panel diagram.....	13
Measure commands	115	Fuse	
Remote commands.....	134	safety instruction	7
SENSe commands	119	Ground	
STATus report commands	134	symbol	5
SYSTEM related commands	131	Indicator	
TRIGger commands	128	reading	31
Continuity		Input jack settings.....	80
beeper	50	Input resistance	79
threshold	49		
Continuity			

Main features.....	11	Serial number	77
Marketing		Service operation	
contact	138	about disassembly	6
Menu tree.....	139	contact	138
Period		Specifications	145
setting	51	Status system	144
Power up.....	24	System menu tree.....	139
Rear panel		Temperature	
overview	21	reference junction temperature ..	56
Refresh rate.....	30	selection	53
Remote control	93	setting	53
Command list.....	103	SIM.....	56
Command syntax	99	thermocouple type	55
EOL	97	units	54
GPIB function check.....	94	Tilt stand	23
interface configuration		Trigger settings.....	86
RS232	95	Triggering	31
USB	94	UK power cord.....	9
TX EOL.....	97	Version number.....	77
Replacing the AC source fuse	141	Voltage	
Replacing the input fuse	142	comparison table	35
Resistance		crest factor	36
range	44	range.....	33
setting	42	setting.....	32
Return from remote control.....	98	Warning symbol.....	5
Safety instruction			
fuse.....	7		

Combined Test Solutions,
4 Commerce Way, Stanbridge Road,
Leighton Buzzard, LU7 4RW

T: 01525 374466
E: sales@ctstest.co.uk
W: www.ctstest.co.uk

