



# Digital Storage Oscilloscope

GDS-3000 Series

---

## USER MANUAL

PART NO. 82DS-33040MC1



ISO-9001 CERTIFIED MANUFACTURER

This manual contains proprietary information, which is protected by copyright. All rights are reserved. No part of this manual may be photocopied, reproduced or translated to another language without prior written consent of Combined Solutions.

The information in this manual was correct at the time of printing. However, Combined Test Solutions continues to improve products and reserves the rights to change specification, equipment, and maintenance procedures at any time without notice.

---

---

# Table of Contents

<b>SAFETY INSTRUCTIONS .....</b>	<b>5</b>
<b>GETTING STARTED .....</b>	<b>10</b>
GDS-3000 Series Overview .....	11
Appearance .....	17
Set Up.....	28
<b>QUICK REFERENCE.....</b>	<b>36</b>
Menu Tree / Operation Shortcuts .....	38
Default Settings .....	52
Built-in Help .....	54
<b>MEASUREMENT.....</b>	<b>55</b>
Basic Measurement .....	57
Cursor Measurement .....	76
Math Operation .....	82
Applications.....	87
Using Go_NoGo .....	90
Power Analysis.....	95
Serial Bus .....	96
<b>CONFIGURATION .....</b>	<b>98</b>
Acquisition .....	100
Display.....	106
Horizontal View .....	112
Vertical View (Channel).....	117
Trigger .....	125
System Info / Language / Clock .....	142
<b>SAVE/RECALL .....</b>	<b>146</b>
File Format/Utility .....	147

Create/Edit file labels.....	151
Save .....	153
Recall .....	160
Reference Waveforms .....	165
<b>FILE UTILITIES.....</b>	<b>167</b>
<b>PRINT OUT.....</b>	<b>174</b>
<b>REMOTE CONTROL CONFIG.....</b>	<b>177</b>
Interface Configuration .....	178
Web Server.....	184
<b>MAINTENANCE .....</b>	<b>187</b>
<b>FAQ .....</b>	<b>194</b>
<b>APPENDIX .....</b>	<b>197</b>
GDS-3000 Specifications.....	197
Probe Specifications .....	202
GDS-3000 Dimensions .....	204
Declaration of Conformity.....	205
<b>INDEX.....</b>	<b>206</b>

# S SAFETY INSTRUCTIONS

This chapter contains important safety instructions that you must follow during operation and storage. Read the following before any operation to insure your safety and to keep the instrument in the best possible condition.

## Safety Symbols

These safety symbols may appear in this manual or on the GDS-3000.

---



WARNING

Warning: Identifies conditions or practices that could result in injury or loss of life.



CAUTION

Caution: Identifies conditions or practices that could result in damage to the GDS-3000 or to other properties.



DANGER High Voltage



Attention Refer to the Manual



Protective Conductor Terminal



Earth (ground) Terminal



Do not dispose electronic equipment as unsorted municipal waste. Please use a separate collection facility or contact the supplier from which this instrument was purchased.

### Safety Guidelines

---

#### General Guideline



#### CAUTION

- Make sure the BNC input voltage does not exceed 300Vrms.
- Never connect a hazardous live voltage to the ground side of the BNC connectors. It might lead to fire and electric shock.
- Do not place any heavy object on the GDS-3000.
- Avoid severe impact or rough handling that leads to damaging the GDS-3000.
- Do not discharge static electricity to the GDS-3000.
- Use only mating connectors, not bare wires, for the terminals.
- Do not block the cooling fan opening.
- Do not perform measurement at a power source or building installation site (Note below).
- Do not disassemble the GDS-3000 unless you are qualified.

(Measurement categories) EN 61010-1:2001 specifies the measurement categories and their requirements as follows. The GDS-3000 falls under category II.

- Measurement category IV is for measurement performed at the source of low-voltage installation.
- Measurement category III is for measurement performed in the building installation.
- Measurement category II is for measurement performed on the circuits directly connected to the low voltage installation.
- Measurement category I is for measurements performed on circuits not directly connected to Mains.

Power Supply	<ul style="list-style-type: none"><li>• AC Input voltage: 100 ~ 240V AC, 48 ~ 63Hz, auto selection. Power consumption: 96VA.</li><li>• Connect the protective grounding conductor of the AC power cord to an earth ground, to avoid electrical shock.</li></ul>
 WARNING	
Cleaning the GDS-3000	<ul style="list-style-type: none"><li>• Disconnect the power cord before cleaning.</li><li>• Use a soft cloth dampened in a solution of mild detergent and water. Do not spray any liquid.</li><li>• Do not use chemical containing harsh material such as benzene, toluene, xylene, and acetone.</li></ul>
Operation Environment	<ul style="list-style-type: none"><li>• Location: Indoor, no direct sunlight, dust free, almost non-conductive pollution (Note below)</li><li>• Relative Humidity: ≤80%, 40°C or below; ≤45%, 41°C ~ 50°C;</li><li>• Altitude: &lt; 2000m</li><li>• Temperature: 0°C to 50°C</li></ul> <p>(Pollution Degree) EN 61010-1:2001 specifies the pollution degrees and their requirements as follows. The GDS-3000 falls under degree 2.</p> <p>Pollution refers to “addition of foreign matter, solid, liquid, or gaseous (ionized gases), that may produce a reduction of dielectric strength or surface resistivity”.</p> <ul style="list-style-type: none"><li>• Pollution degree 1: No pollution or only dry, non-conductive pollution occurs. The pollution has no influence.</li><li>• Pollution degree 2: Normally only non-conductive pollution occurs. Occasionally, however, a temporary conductivity caused by condensation must be expected.</li><li>• Pollution degree 3: Conductive pollution occurs, or dry, non-conductive pollution occurs which becomes conductive due to condensation which is expected. In such conditions, equipment is normally protected against exposure to direct sunlight, precipitation, and full wind pressure, but neither temperature nor humidity is controlled.</li></ul>
Storage environment	<ul style="list-style-type: none"><li>• Location: Indoor</li><li>• Temperature: -10°C to 60°C 40°C /93% RH 41°C ~60°C /65% RH</li></ul>

---

Disposal



Do not dispose this instrument as unsorted municipal waste. Please use a separate collection facility or contact the supplier from which this instrument was purchased. Please make sure discarded electrical waste is properly recycled to reduce environmental impact.

## Power cord for the United Kingdom

When using the oscilloscope in the United Kingdom, make sure the power cord meets the following safety instructions.

NOTE: This lead/appliance must only be wired by competent persons



**WARNING: THIS APPLIANCE MUST BE EARTHED**

IMPORTANT: The wires in this lead are coloured in accordance with the following code:

Green/ Yellow:	Earth
Blue:	Neutral
Brown:	Live (Phase)



As the colours of the wires in main leads may not correspond with the coloured marking identified in your plug/appliance, proceed as follows:

The wire which is coloured Green & Yellow must be connected to the Earth terminal marked with either the letter E, the earth symbol  or coloured Green/Green & Yellow.

The wire which is coloured Blue must be connected to the terminal which is marked with the letter N or coloured Blue or Black.

The wire which is coloured Brown must be connected to the terminal marked with the letter L or P or coloured Brown or Red.

If in doubt, consult the instructions provided with the equipment or contact the supplier.

This cable/appliance should be protected by a suitably rated and approved HBC mains fuse: refer to the rating information on the equipment and/or user instructions for details. As a guide, a cable of 0.75mm<sup>2</sup> should be protected by a 3A or 5A fuse. Larger conductors would normally require 13A types, depending on the connection method used.

Any exposed wiring from a cable, plug or connection that is engaged in a live socket is extremely hazardous. If a cable or plug is deemed hazardous, turn off the mains power and remove the cable, any fuses and fuse assemblies. All hazardous wiring must be immediately destroyed and replaced in accordance to the above standard.

# GETTING STARTED

This chapter describes the GDS-3000 in a nutshell, including its main features and front / rear panel introduction. After going through the overview, follow the Set Up section to properly set up the oscilloscope for first-time use. The Set Up section also includes a starter on how to use this manual effectively.



<b>GDS-3000 Series Overview .....</b>	<b>11</b>
Series lineup .....	11
Main Features .....	12
Accessories.....	13
Package Contents .....	16
<b>Appearance .....</b>	<b>17</b>
GDS-3504/3354/3254/3154 Front Panel .....	17
GDS-3502/3352/3252/3152 Front Panel .....	17
Rear Panel .....	23
Display.....	25
<b>Set Up.....</b>	<b>28</b>
Tilt Stand.....	28
Power Up .....	29
First Time Use .....	30
How to Use This Manual.....	32

## GDS-3000 Series Overview

### Series lineup

The GDS-3000 series consists of 8 models, divided into 2-channel and 4-channel versions.

Model name	Frequency bandwidth	Input channels	Real-time Sampling Rate
GDS-3152	150MHz	2	2.5GSa/s
GDS-3252	250MHz	2	2.5GSa/s
GDS-3352	350MHz	2	5GSa/s
GDS-3502	500MHz	2	4GSa/s
GDS-3154	150MHz	4	5GSa/s
GDS-3254	250MHz	4	5GSa/s
GDS-3354	350MHz	4	5GSa/s
GDS-3504	500MHz	4	4GSa/s

The 2 channel and 4 channel models differ in the position of the horizontal controls, the math, reference and bus keys as well as the position of the EXT trigger.

2-Channel models

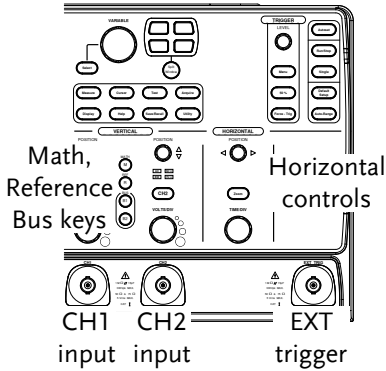

4-Channel models

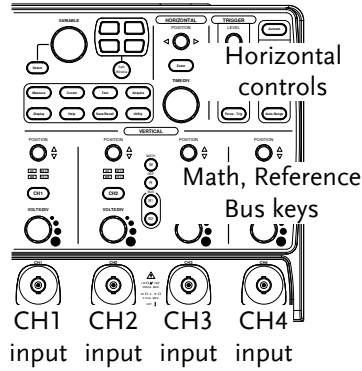

Main Features

- |             |   |
|-------------|---|
| Performance | <ul style="list-style-type: none"> <li>• High sampling rate: up to 5GSa/s real-time (4GSa/s GDS-350X), 100GSa/s equivalent-time</li> <li>• Deep memory: 25k points record length</li> <li>• Minimum 2ns peak detection</li> </ul>   |
| Features    | <ul style="list-style-type: none"> <li>• 2 and 4 channel models</li> <li>• Bandwidth up to 500 MHz</li> <li>• 5GSa/s (200ps resolution) real-time sampling rate (4GSa/s, 250ps resolution for GDS-350X)</li> <li>• 100GSa/s equivalent sample rate</li> <li>• VPO waveform processing</li> <li>• Large 8'' 800 x 600 high-resolution TFT LCD</li> <li>• Unique split window function</li> <li>• Flexible application modules</li> </ul> |

- Three standard input impedances (50Ω/75Ω/1MΩ)
- Optional power measurement functions are available for fast analysis of power quality tests
- Optional analysis software for I<sup>2</sup>C, SPI and UART serial signal triggering and decoding
- 2 and 4 channel models available up to 500 MHz
- Large 8" color TFT LCD, supporting a large 8 x 10 graticule
- On-screen Help
- 64 MB internal flash memory.
- FreeWave remote control software (free download)

- Interface
- USB host port: front and rear panel, for storage devices
  - USB slave port(Optional GPIB to USB), RS-232C port: for remote control
  - Calibration output
  - Go-No Go output
  - Trigger output
  - Ethernet port

### Accessories

Standard Accessories	Part number	Description
	82DS-33040MA1	User manual
	N/A region dependent	Power cord
Options	Option Number	Description
	DS3-PWR	Power analysis software
	DS3-SBD	Series Bus analysis software

	GPIB to USB adapter	GPIB Interface
Optional Accessories	Part number	Description
	GTC-001	Instrument cart, 470(W)x430(D)mm (U.S. type input socket)
	GTC-002	Instrument cart, 330(W)x430(D)mm (U.S. type input socket)
	GTL-110	test lead, BNC to BNC heads
	GTL-232	RS-232C cable, 9-pin Female to 9-pin female, Null modem for computer
	GTL-246	USB cable, USB2.0A-B type cable 4P
	GDB-03	Demoboard for the GDS-3000 Series DSO
	GDP-025	25MHz high voltage differential probe
	GDP-050	50MHz high voltage differential probe
	GDP-100	100MHz high voltage differential probe
	GCP-005	5A/ 40Hz~1kHz current probe
	GCP-020	200A/40Hz~10kHz current probe
	GCP-100	100A/DC~100kHz current probe
	GCP-530	50MHz/ 30A current probe
	GCP-1030	100MHz/ 30A current probe
	GCP-206P	Power supply for current probe (2 input channels)
	GCP-425P	Power supply for current probe (4 input channels)
	GTP-151R	Passive probe; 150 MHz,10X with readout
	GTP-251R	Passive probe; 250 MHz, 10X with readout

GTP-351R	Passive probe; 350 MHz, 10X with readout
GTP-501R	Passive probe, 500MHz, 10X with readout

### Drivers

USB driver

LabVIEW driver

### Package Contents

Check the contents before using the GDS-3000.

---

#### Opening the Box

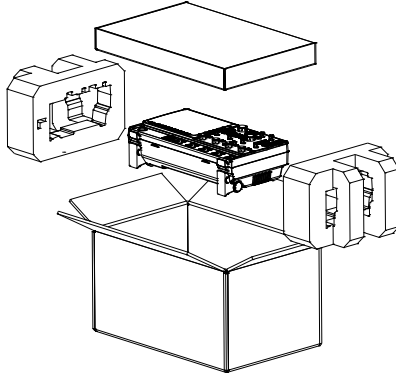

#### Contents

- Main unit
  - Probe set
    - GTP-151R for GDS-3152 / GDS-3154
    - GTP-251R for GDS-3252 / GDS-3254
    - GTP-351R for GDS-3352 / GDS-3354
    - GTP-501R for GDS-3502 / GDS-3504
  - Power cord
  - User manual (this document)
- 

#### Note

- For detailed probe specifications, see page 202.
- The programming manual, PC software, and USB driver are downloadable from the GW Instek website. Visit [www.gwinstek.com](http://www.gwinstek.com), in the oscilloscope section.

# Appearance

## GDS-3504/3354/3254/3154 Front Panel

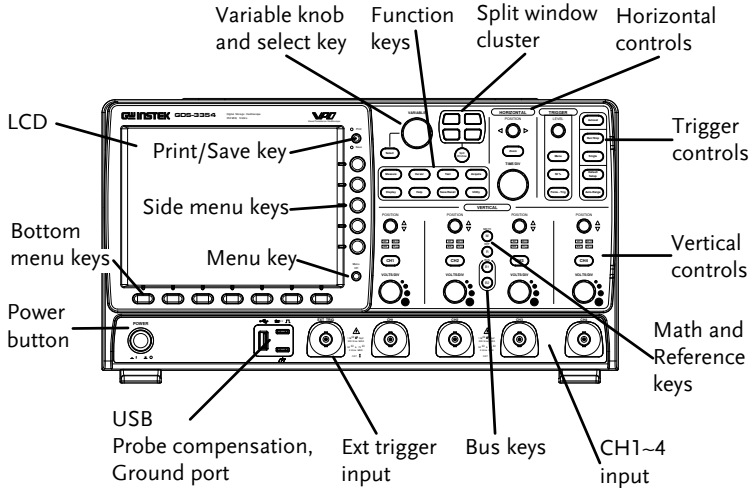

## GDS-3502/3352/3252/3152 Front Panel

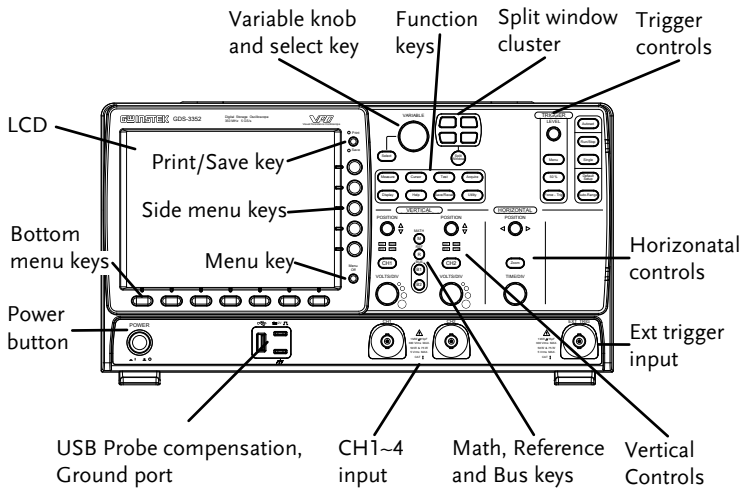

LCD Display 8" SVGA TFT color LCD. 800 x 600 resolution, wide angle view display.

Menu Key  Menu Off Use the Menu Off key to hide the onscreen menu system.



Side Menu Keys The Side menu and Bottom menu keys are used to make selections from the soft-menus on the LCD user interface.

Bottom Menu Keys

To choose menu items, use the 7 Bottom menu keys located on the bottom of the display panel.

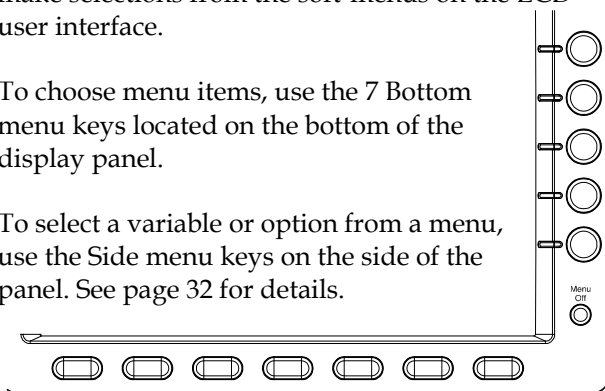
To select a variable or option from a menu, use the Side menu keys on the side of the panel. See page 32 for details.



Print/Save Key  Print The print/save key is a quick save or quick print key, depending on its configuration. For more information see pages 155(save) or 175(print).  
 Save

Variable Knob and Select Key

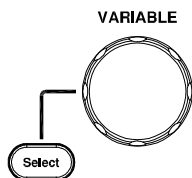

The Variable knob is used to increase/decrease values or to move between parameters.

The select key is used to make selections.

Split Window Cluster

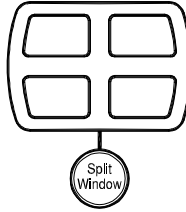

Use the Split Window key to cycle between single and split screen mode. For more details on windowing, see page 66.

Horizontal Controls

The horizontal controls are used to change the position of the cursor, set the time base settings, and to zoom into the waveforms.

Horizontal Position

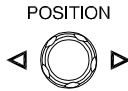

The Position knob is used to position the waveforms horizontally on the display screen.

Zoom



Press Zoom in combination with the horizontal POSITION knob.

TIME/DIV



The Time/Div knob is used to change the horizontal scale.

Trigger Controls

The trigger controls are used to control the trigger level and options.

Level Knob



Used to set the trigger level.

Trigger Menu Key



Used to bring up the trigger menu.

50% Key



















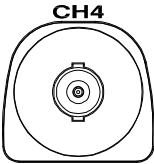



Sets the trigger level to the half way point (50%).

Force - Trig



Press to force an immediate trigger of the waveform.

Autoset		Press the Autoset key to automatically set the trigger, horizontal scale and vertical scale.
Run/Stop Key		Press to freeze (Stop) or continue (Run) signal acquisition (page59).
Single		Sets the acquisition mode to single triggering mode.
Default Setup		Resets the oscilloscope to default settings.
Auto-Range		Sets the oscilloscope range automatically.
Vertical POSITION		Sets the vertical position of the waveform.
Channel Menu Key		Press the CH1~4 key to set the channel.
VOLTS/DIV Knob		Sets the vertical scale.
Input Terminals		Accepts input signals. Input impedance, selectable: 50Ω, 75Ω, 1MΩ.
Math Key		Use the math key to set and configure math functions.

Reference Key		Press the Reference key to set or remove reference waveforms.
BUS Keys		The Serial bus decode keys are used for UART, I <sup>2</sup> C and SPI serial bus interface decoding. The serial bus decode function is an optional extra. See page 95 for details.
Function Keys	The Function Keys are used to enter and configure different functions on the GDS-3000.	
Measure		Configures and runs automatic measurements.
Cursor		Configures and runs cursor measurements.
Test		Configures and runs GW Instek applications and optional functions such as the Power Analysis measurement software.
Acquire		Configures the Acquisition mode.
Display		Configures the display settings.
Help		Shows the Help menu.
Save/Recall		Used to save and recall waveforms, images and panel settings.
Utility		Configures the print/save key, display time, language and calibration.

USB Host Port

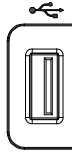

Type A, 1.1/2.0 compatible. Used for data transfer.

Ground Terminal



Accepts the DUT ground lead for common ground.

Probe Compensation Output



Outputs 2Vp-p, square wave signal for probe compensation (page 191).

External Trigger Input



Accepts external trigger signals (page 125).

Input impedance:  $1M\Omega \pm 3\%$ ,  
Voltage input:  $\pm 15V$ (peak), EXT trigger capacitance:  $\sim 16pF$ .

Power Switch

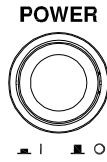

Used to turn the power on/off.

■ | ○: ON

■ | ○: OFF

Rear Panel

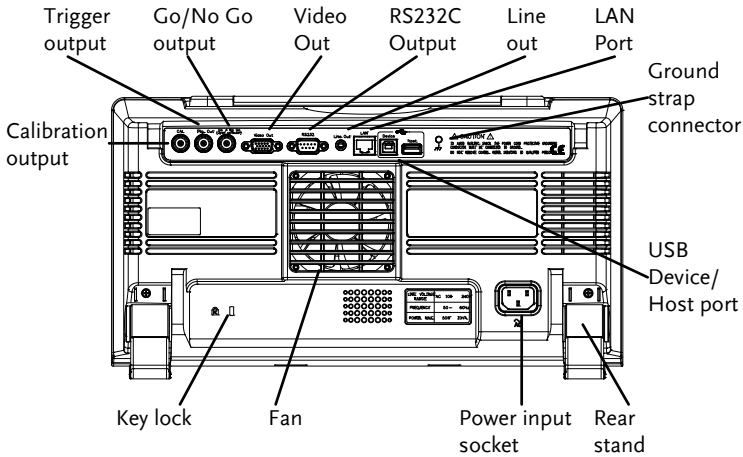

Calibration Output



Outputs the signal for vertical scale accuracy calibration (page 187).

Trigger Output



Outputs the trigger timing.

Go-No Go Output



Outputs Go-No Go test results (page 87) as 500us pulse signal.

Video Out



Outputs SVGA resolution to an external display.

RS232

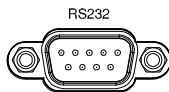

RS232 remote control.

Line Out



Audio line out.

LAN Port



Ethernet port.

Ground Strap Connector



For use with a grounding strap.

USB Device Port



The USB device port is used for remote control and for the FreeWave remote control software. USB 1.1/2.0 high speed compatible.

USB Host



The USB host port supports USB flash drives for external memory. USB 1.1/2.0 high speed compatible.

Security Slot



Kensington security slot compatible.

Power Input Socket

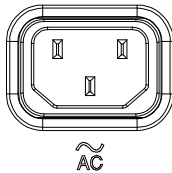

Power cord socket accepts AC mains, 100 ~ 240V, 50/60Hz.

For power up sequence, see page 29.

## Display

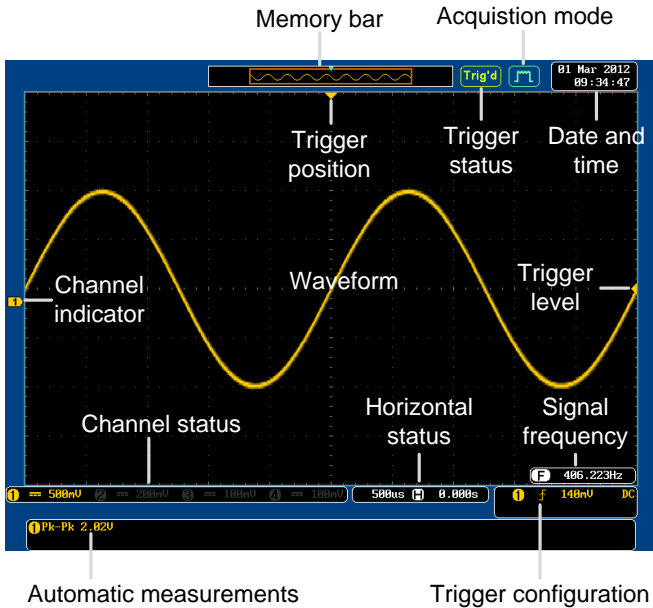

## Waveforms

Shows input signal waveforms.

Channel 1: Yellow

Channel 2: Blue

Channel 3: Pink

Channel 4: Green

## Channel Indicator

The channel indicator shows the zero volt level of the signal waveform for each activated channel. The active channel is shown with a solid color.

Math

Bus (B1)

Active channel (CH3)

Reference waveform (Ref1)

Activated channel (CH4)

## Trigger Position

Shows the position of the trigger.

## Horizontal Status

Shows the horizontal scale and position.

Date and Time  Current date and time (page 144).

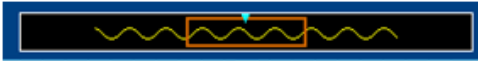
Memory Bar 

The ratio and the position of the displayed waveform compared with the internal memory (page 112).

Trigger Status  Triggered.

 Not triggered, display not updated.

 Trigger stopped. Also appears in Run/Stop (page 59).

 Roll mode.

 Auto trigger mode.

For trigger details, see page 125.

Acquisition Mode  Normal mode

 Peak detect mode

 Hi Resolution

 Average mode

For acquisition details, see page 100.

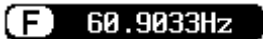
Signal Frequency  Shows the trigger source frequency.

 Indicates the frequency is less than 2Hz (lower frequency limit).

Trigger Configuration  Trigger source, slope, voltage, coupling.

 Trigger source, trigger (video), field, line, coupling.

For trigger details, see page 125.

Channel Status  Channel 1, inverted, AC coupling, 1V/Div

 Channel 1, GND coupling, 1V/Div

For channel details, see page 117.

## Set Up

### Tilt Stand

---

#### Upright

Turn the legs under the casing as shown below to have the instrument sit upright.

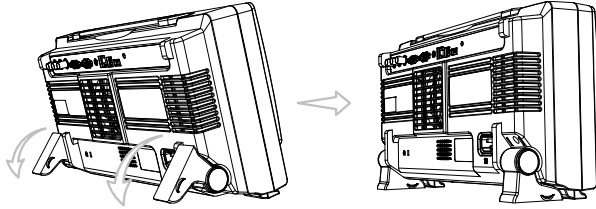

---

#### Tilt

To tilt, tilt the legs back behind the casing, as shown below.

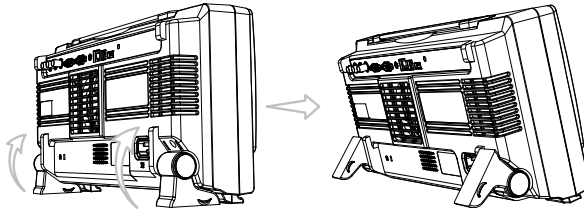

## Power Up

Step

1. Connect the power cord to the rear panel socket.

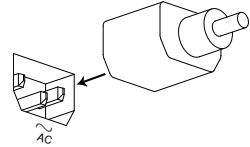

2. Press the POWER key. The display becomes active in ~ 30 seconds.



■ | ON

■ ○: OFF

Note

The GDS-3000 recovers the state right before the power is turned OFF. The default settings can be recovered by pressing the Default key on the front panel. For details, see page 160.

## First Time Use

**Background** This section describes how to connect a signal, adjust the scale, and compensate the probe. Before operating the GDS-3000 in a new environment, run these steps to make sure the instrument performs at its full potential.

1. Power On Follow the procedures on the previous page.

2. Set the Date and Time Set the date and time. Page 144

3. Reset System Reset the system by recalling the factory settings. Press the *Default Setup* key on the front panel. For details, see page 160.



4. Install Optional Software The optional software packages (Power Analysis, Serial Bus Decode) can be activated. Page 192

5. Connect Probe Connect the probe to the CH1 input terminal and probe compensation signal output (2Vp-p, 1kHz square wave).

Set the probe attenuation to x10 if the probe has adjustable attenuation.

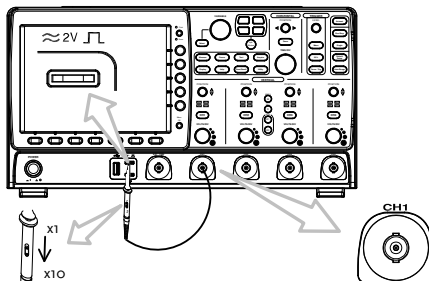

6. Capture Signal (Autoset)

Press the *Autoset* key. A square waveform appears on the center of the screen. For Autoset details, see page 58.

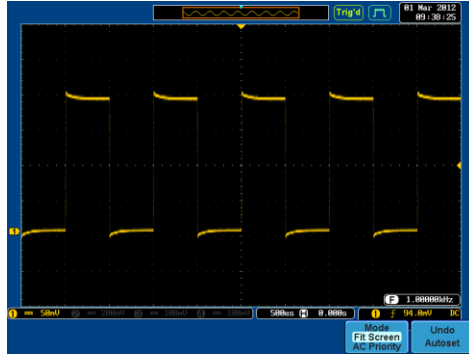

7. Select Vector Waveform

Press the *Display* key, and set the display to *Vector* on the bottom menu.

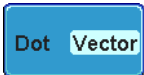
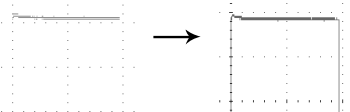
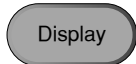

8. Compensate Probe

Turn the adjustment point on the probe to make the square waveform edge flat.

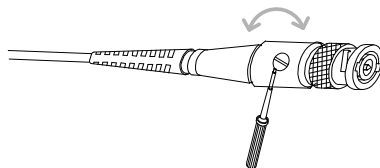
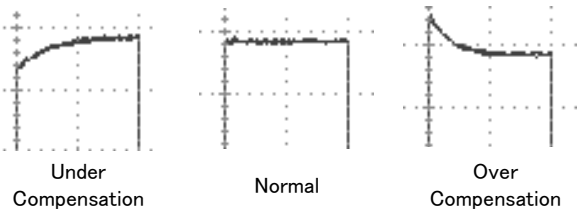

9. Start Operation Continue with the other operations.

Measurement: page 55	Configuration: page 87
Save/Recall page 146	File Utilities page 166
Print Out 174	Remote Control page 177

## How to Use This Manual

---

**Background** This section describes the conventions used in this manual to operate the GDS-3000.

Throughout the manual any reference to pressing a menu key refers to the keys directly below or beside any menu icons or parameters.

When the user manual says to “toggle” a value or parameter, press the corresponding menu item. Pressing the item will toggle the value or parameter.

Active parameters are highlighted for each menu item. For example in the example below, Coupling is currently set to DC.

If a menu item can be toggled from one value or parameter to another, both options will be visible, with the current option highlighted. In the example below the slope can be toggled from a rising slope to a falling slope.

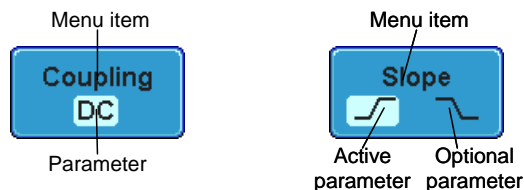

**Selecting a Menu Item or Parameter** When the user manual says to “select” a value from one of the side menu parameters, first press the corresponding menu key and use the variable knob to either scroll through a parameter list or to increase or decrease a variable.

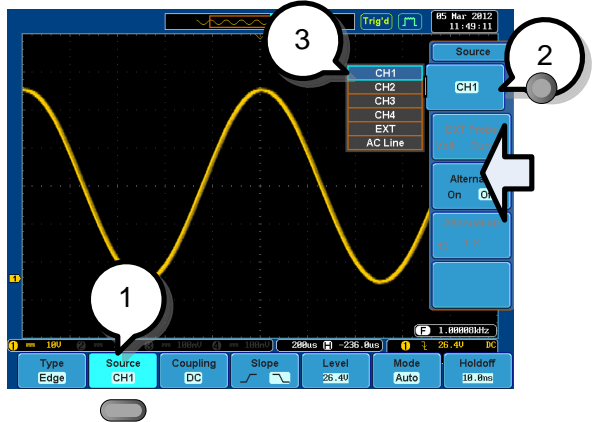

Example

1. Press a bottom menu key to access the side menu.

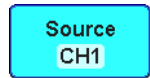

2. Press a side menu key to either set a parameter or to access a sub menu.



3. If accessing a sub menu or setting a variable parameter, use the variable knob to scroll through menu items or variables. Use the select key to confirm and exit.

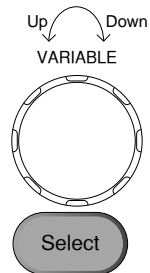

4. Press the same bottom menu key again to reduce the side menu.

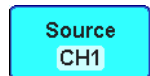

Toggling a Menu Parameter

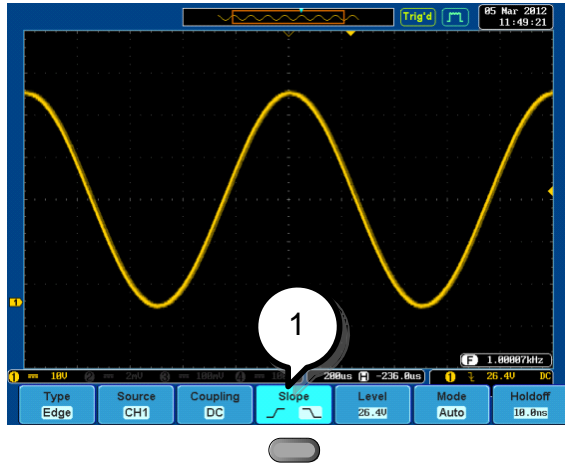

1. Press the bottom menu key to toggle the parameter.



Reduce Lower Menu

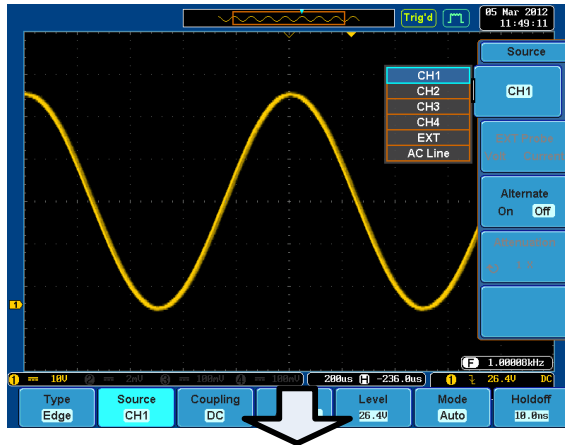

1. Press the relevant function key again to reduce the bottom menu. For example: press the trigger menu key to reduce the trigger menu.

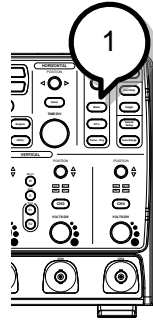

Remove All Menus

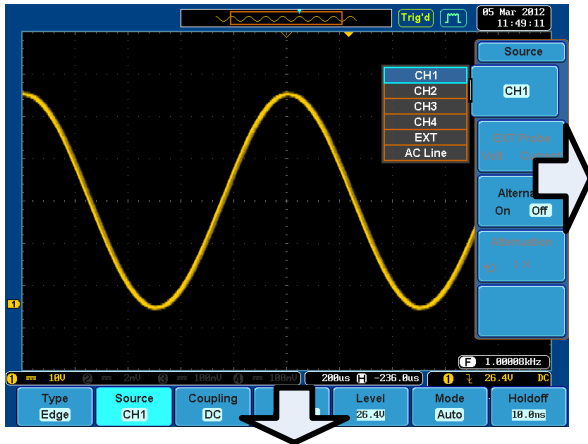

1. Press the Menu Off key to reduce each menu level.

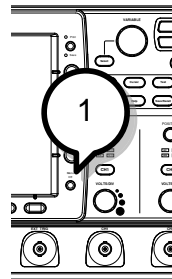

# QUICK REFERENCE

This chapter describes the GDS-3000 menu tree, shortcuts to major operations, built-in Help access, and default factory settings. Use them as a handy reference to get a quick access to the functionality.

<b>Menu Tree / Operation Shortcuts .....</b>	<b>38</b>
Convention .....	38
Acquire Key .....	39
Autoset Key .....	39
Auto-Range .....	40
CH1 ~ 4 Key .....	40
Cursor Key .....	41
Display Key .....	41
Help Key .....	41
Math Key .....	42
Measure Key .....	43
Print/Save Key .....	44
Run/Stop Key .....	44
REF Key .....	44
Save/Recall Key .....	45
Test Key .....	46
Test Key – Go-NoGo .....	46
Trigger Type Menu .....	47
Trigger Edge Menu .....	47
Trigger Delay Menu .....	47
Trigger Pulse Width Menu .....	48
Trigger Video Menu .....	48
Trigger Pulse Runt Menu .....	49
Trigger Rise & Fall Menu .....	49
Utility Key .....	50
Utility Key – I/O .....	50
Utility Key – File Utilities .....	51
Zoom Key .....	51

**Default Settings ..... 52**

**Built-in Help ..... 54**

# Menu Tree / Operation Shortcuts

## Convention

For all menu trees, bottom menu keys are shown as grey icons and side menu keys are shown in white. All menu tree operations are shown in order from top to bottom.

Below is an example of the menu tree operation for the trigger source menu and a comparison to the operation on the DSO screen.

### Menu Tree

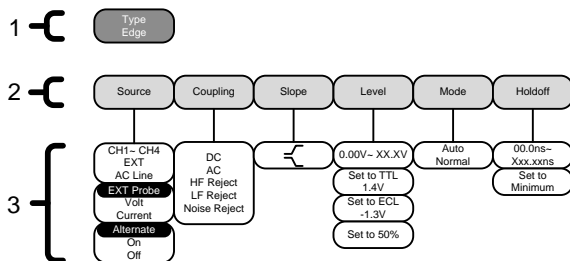

### On Screen Menu

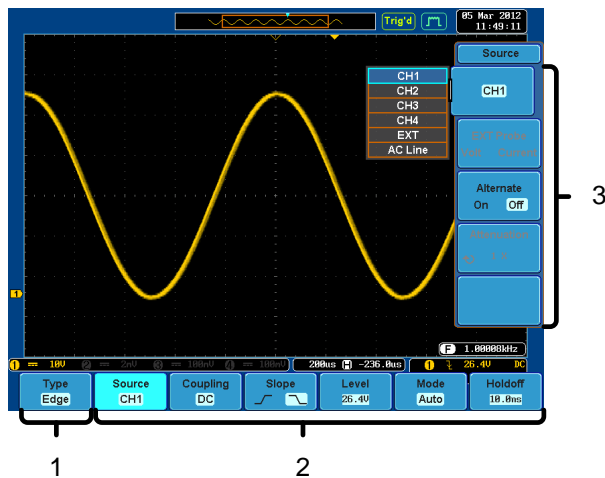

## Acquire Key

Sets the acquisition mode.

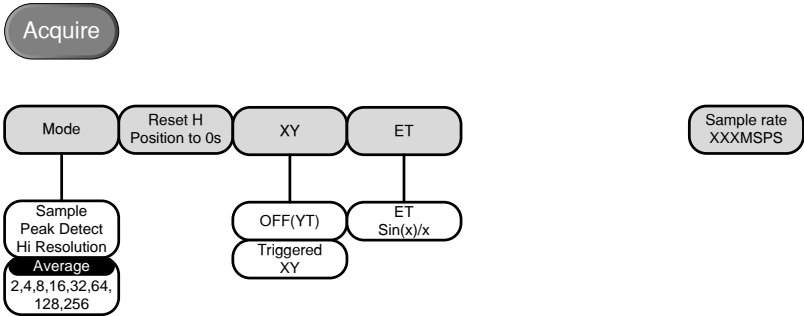

## Autoset Key

Automatically finds the signal and sets the horizontal and vertical scale.



## Auto-Range

Constantly adjusts the vertical and or horizontal scale.

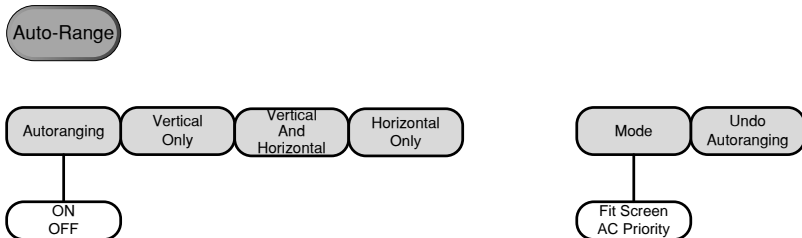

## CH1 ~ 4 Key

Set the channel input parameters.

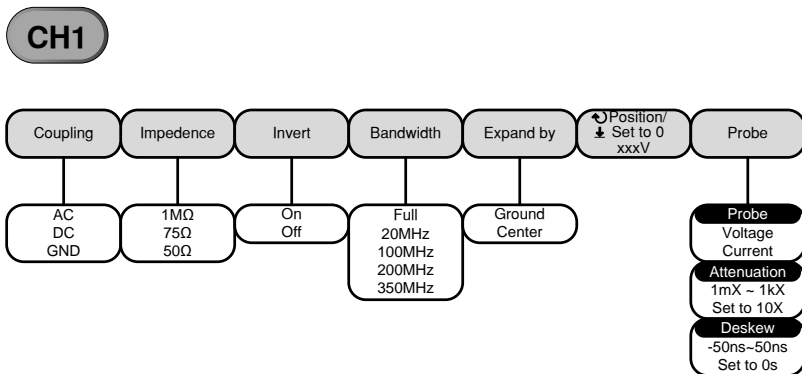

## Cursor Key

Set cursor positions.

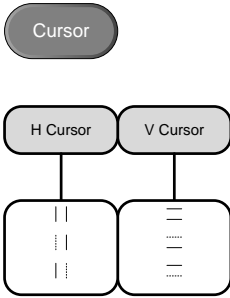

## Display Key

Set the display properties.

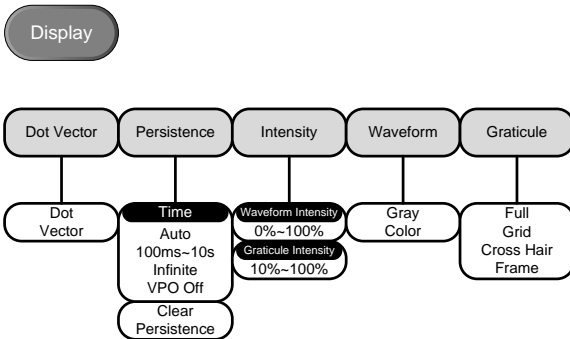

## Help Key

Turn help mode On/Off.



# Math Key



Standard math and FFT functions.

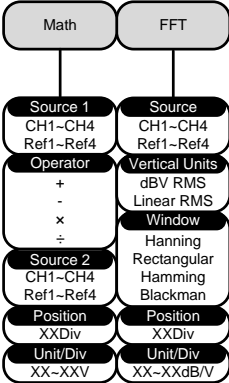

## Measure Key

Display automatic measurements either individually or as voltage/current, time or delay measurement groups.

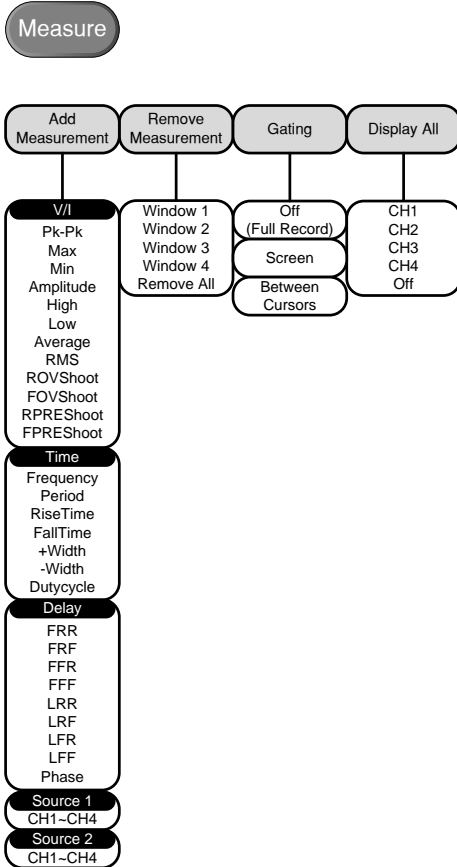

### Print/Save Key

Print      Print or save screen images.



Save

### Run/Stop Key



Freeze/unfreeze signal acquisition

### REF Key

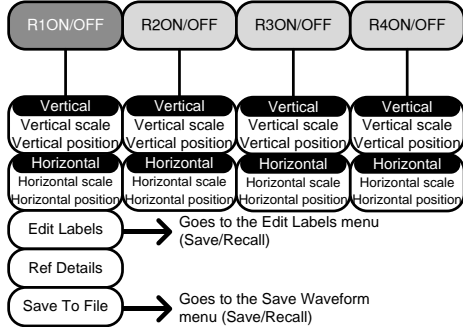

## Save/Recall Key

Save and recall images, waveforms and panel setups. Edit labels for reference and setup files.

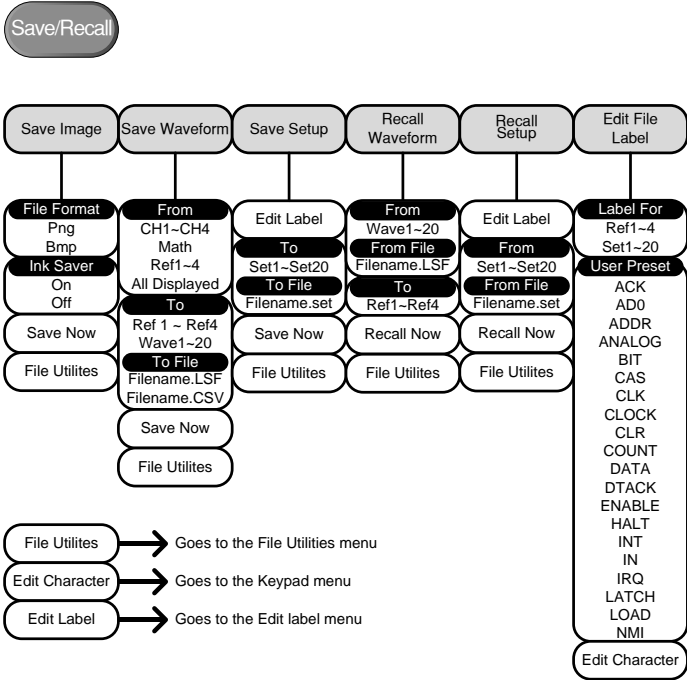

### Test Key

Use the Go-NoGo application as well as additional optional software such as the Power Analysis software.

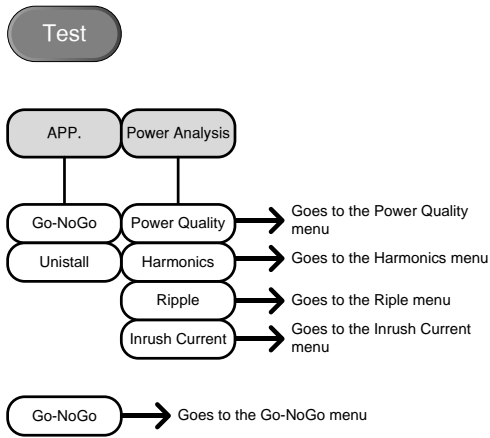

### Test Key – Go-NoGo

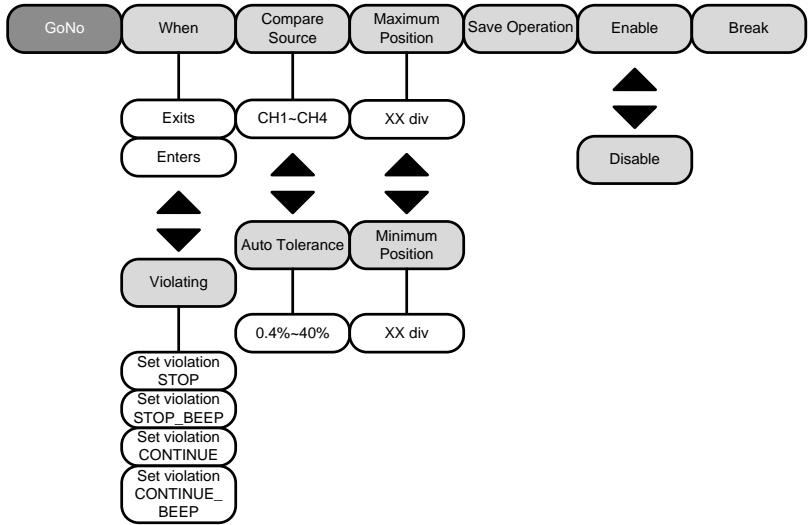

## Trigger Type Menu

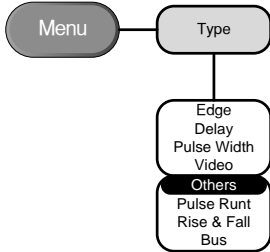

## Trigger Edge Menu

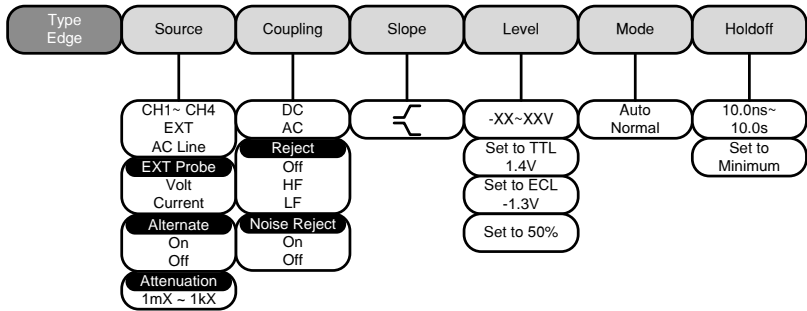

## Trigger Delay Menu

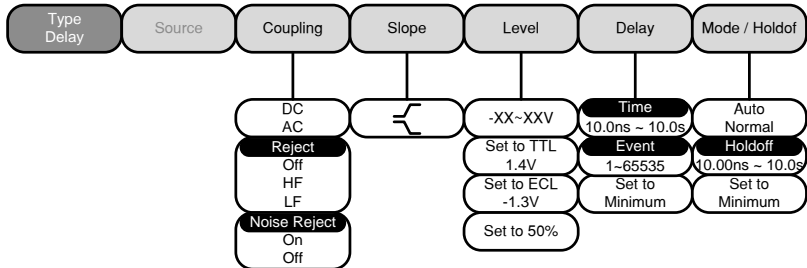

## Trigger Pulse Width Menu

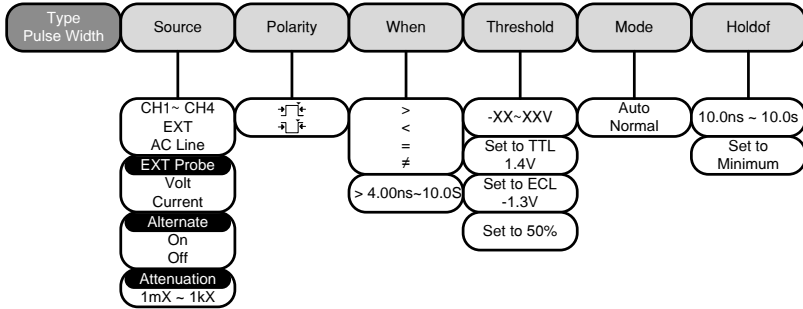

## Trigger Video Menu

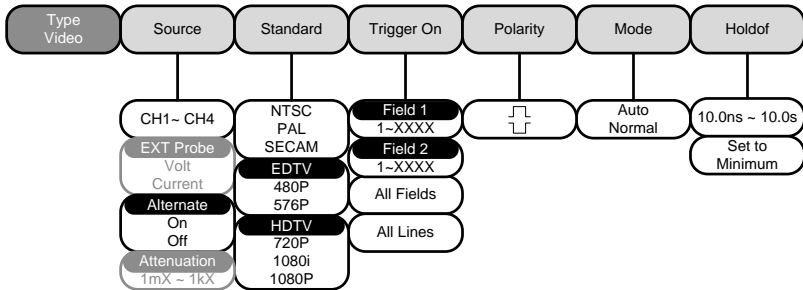

## Trigger Pulse Runt Menu

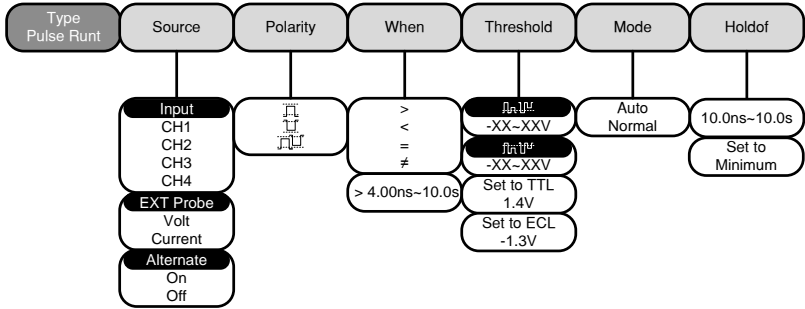

## Trigger Rise & Fall Menu

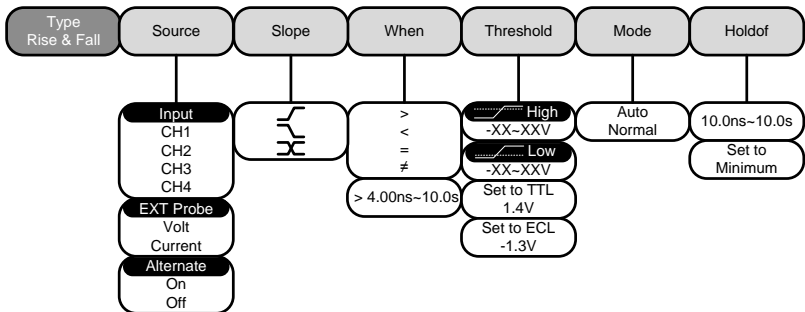

## Utility Key

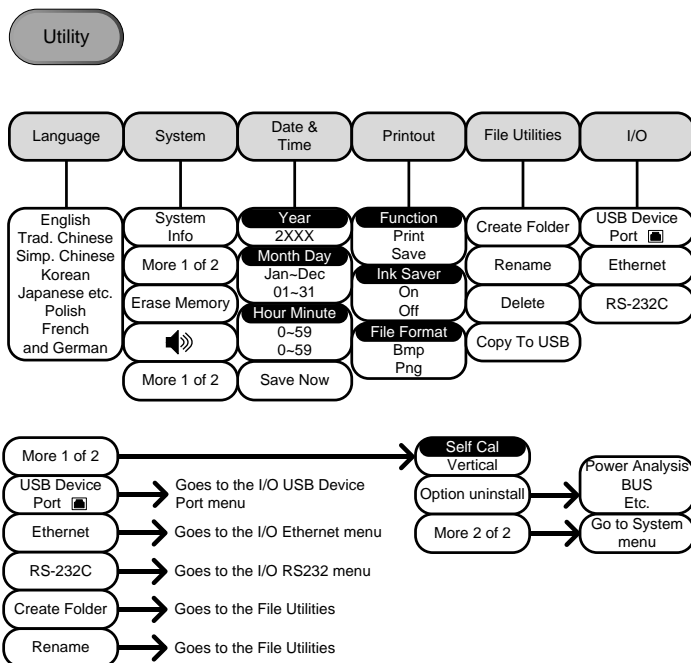

## Utility Key – I/O

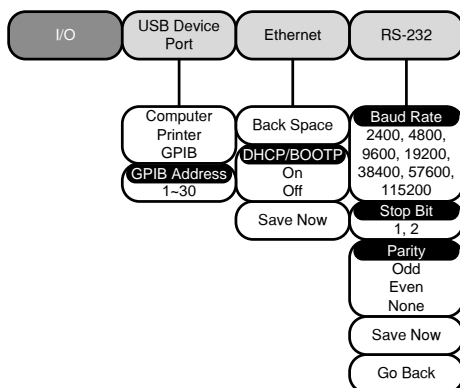

## Utility Key – File Utilities

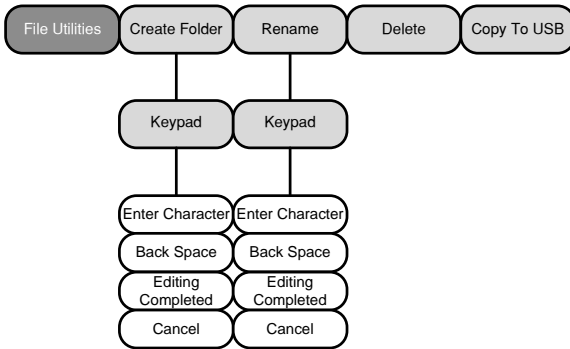

## Zoom Key

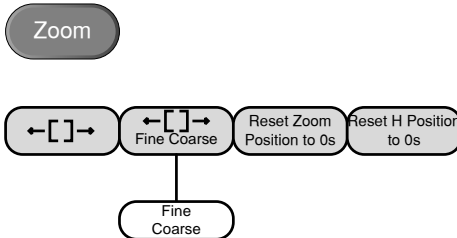

## Default Settings

The default factory installed settings can be recalled at any time by pressing the *Default Setup* key.



Acquire	Mode: Sample Interpolation: Sin(x)/x	XY: OFF Sample rate: 250MSPS (200MSPS GDS350X)
Display	Mode: Vector Waveform intensity: 50% Waveform visuals: Gray	Persistence: Auto Graticule intensity: 50% Graticule: full 
Channel	Scale: 100mV/Div Coupling: DC Invert: Off Expand: By ground Probe: voltage Deskew: 0s	CH1: On Impedance: 1MΩ Bandwidth: full Position: 0.00V Probe attenuation: 1x
Cursor	Horizontal cursor: Off	Vertical Cursor: Off
Measure	Source1: CH1 Gating: Off	Source2: CH2 Display: Off
Horizontal	Scale: 10us/Div	
Math	Source1: CH1 Source2: CH2 Unit/Div: 200mV	Operator: + Position: 0.00 Div Math Off
Test	App: Go-NoGo	
Trigger	Type: Edge Coupling: DC Rejection: Off	Source: CH1 Alternate: Off Noise Rejection: Off

## QUICK REFERENCE

---

	Slope: positive	Level: 0.00V
	Mode: Auto	Holdoff: 10.0ns
Utility	Print key: Save	Ink Saver: Off
Save Recall	Image file format: Bmp	Data file format: LSF

## Built-in Help

The Help key accesses a context sensitive help menu. The help menu contains information on how to use the front panel keys.

Panel Operation 1. Press the *Help* key. The display changes to Help mode.



2. Use the Variable knob to scroll up and down through the Help contents. Press *Select* to view the help on the selected item.



Home Key Press the *Home* key to return to the main help screen.



Go Back Press the *Back* key to go to the previous menu page.



Exit Press the *Help* key again or press the *Exit* key to exit the Help mode.



# M EASUREMENT

<b>Basic Measurement</b> .....	<b>57</b>
Channel Activation .....	57
Autoset .....	58
Auto-Range .....	60
Run/Stop .....	62
Horizontal Position/Scale.....	63
Vertical Position/Scale .....	65
Split Window Mode .....	66
Automatic Measurement.....	68
Measurement Items .....	68
Individual Mode .....	71
Remove Measurement.....	72
Gated mode .....	73
Display All mode.....	74
<b>Cursor Measurement</b> .....	<b>76</b>
Use Horizontal Cursors.....	76
Use Vertical Cursors .....	79
<b>Math Operation</b> .....	<b>82</b>
Overview .....	82
Addition/Subtraction/Multiplication/Division .....	83
FFT .....	85
<b>Applications</b> .....	<b>87</b>
Overview .....	87
Running Applications .....	87
Uninstalling Applications .....	88
<b>Using Go_NoGo</b> .....	<b>90</b>
<b>Power Analysis</b> .....	<b>95</b>
Power Analysis Overview .....	95
<b>Serial Bus</b> .....	<b>96</b>

Serial Bus Overview.....96

## Basic Measurement

This section describes the basic operations required in capturing and viewing the input signal. For more detailed operations, see the following chapters.

- Cursor Measurement → from page 76
- Configuration → from page 87

Before operating the oscilloscope, please see the Getting Started chapter, page 10.

### Channel Activation

**Activate Channel** To activate an input channel, press a *channel* key.

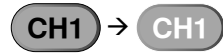

When activated, the channel key will light up. The corresponding channel menu will also appear.

Each channel is associated with the color shown beside the VOLTS/DIV dial: CH1: yellow, CH2: blue, CH3: pink and CH4: green.

When a channel is activated, it is shown above the bottom menu system.

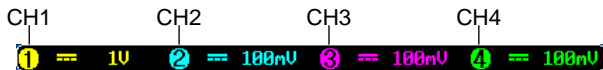

**De-activate Channel** To de-activate a channel, press the corresponding *channel* key again. If the channel menu is not open, press the *channel* key twice (the first press shows the Channel menu).

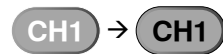

Default Setup	To activate the default state, press <i>Default Setup</i> .	
---------------	---	---

---

Autoset	The <i>Autoset</i> key (page 58) does NOT automatically activate the channels to which input signals are connected.
---------	---

## Autoset

---

Background	<p>The Autoset function automatically configures the panel settings to position the input signal to the best viewing condition. The GDS-3000 automatically configures the following parameters.</p>
------------	---

- Horizontal scale
- Vertical scale
- Trigger source channel

There are two operating modes for Autoset function: Fit Screen Mode and AC Priority Mode.

Fit Screen Mode will fit the waveform to the best scale, including any DC components (offset). AC priority mode will scale the waveform to the screen removing any DC component.

---

Panel Operation	<ol style="list-style-type: none"> <li>1. Connect the input signal to the GDS-3000 and press the <i>Autoset</i> key.</li> <li>2. The waveform appears in the center of the display.</li> </ol>	
-----------------	--	---

Before

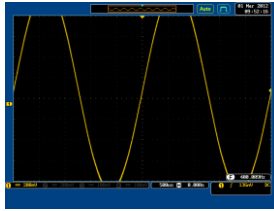

After

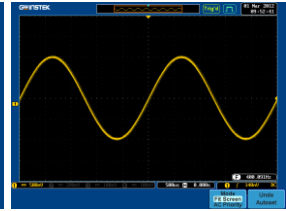

- To undo Autoset, press *Undo Autoset* from the bottom menu. To remove the *Undo Autoset* softkey, press any other key.

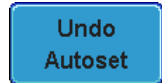

Change modes

- Choose between *Fit Screen Mode* and *AC Priority Mode* from the bottom menu.

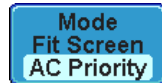

- Press the *Autoset* key again to use Autoset in the new mode.



Fit Screen Mode

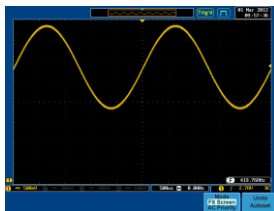

AC Priority

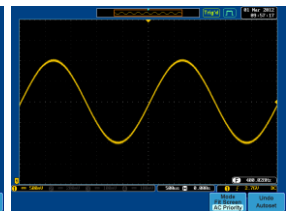

Limitation

Autoset does not work in the following situations.

- Input signal frequency is less than 20Hz
- Input signal amplitude is less than 30mV

## Auto-Range

**Background** The Auto-Range function works similarly to the Autoset function, except the Auto-Range function works continuously when it is on. The Auto-Range function will continuously monitor the input signal and adjust the horizontal and vertical scale of a displayed signal so that waveform(s) are displayed at the best possible scale.

In addition, the Auto-Range function can also be configured to only adjust the vertical or horizontal scale.

There are two operating modes for the Auto-Range function: Fit Screen Mode and AC Priority Mode.

Fit Screen Mode will fit the waveform to the best scale, including any DC components (offset). AC priority mode will scale the waveform to the screen removing any DC component.

- Panel Operation**
1. After a signal has already been triggered, press the *Auto-Range* key. The *Auto-Range* key lights up.

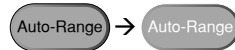

2. The waveform appears in the center of the display.

Before

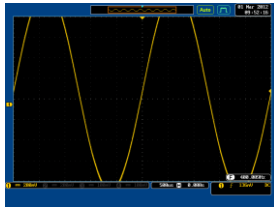

After

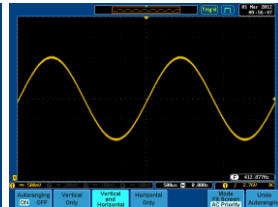

3. To undo Auto-Range, press *Undo Autoranging* from the bottom menu.

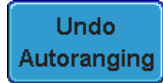

Disable Auto-Range

Press *Autoranging* from the bottom menu to turn Auto-Range On/Off.

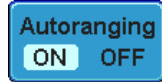

Configure Auto-Range

Press *Vertical Only* for vertical autoranging only.



Press *Horizontal Only* for horizontal autoranging only.

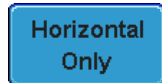

Press *Horizontal and Vertical* for autoranging on both axes.



Change modes

1. Choose between *Fit Screen Mode* and *AC Priority Mode* from the bottom menu.

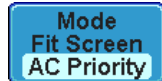

2. Press the *Auto-Range* key twice to reset the Auto-Range function.



x2

Fit Screen Mode

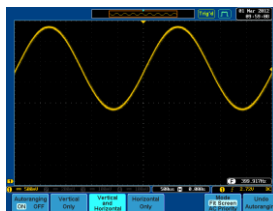

AC Priority

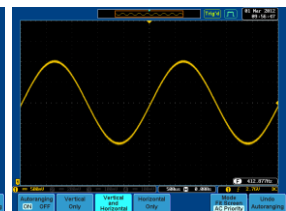

Limitation

Auto-Range does not work in the following situation.

- Input signal frequency is less than 20Hz
- Input signal amplitude is less than 30mV

## Run/Stop

**Background** By default, the waveform on the display is constantly updated (Run mode). Freezing the waveform by stopping signal acquisition (Stop mode) allows flexible observation and analysis. To enter Stop mode, two methods are available: pressing the Run/Stop key or using the Single Trigger mode.

**Stop mode icon** When in Stop mode, the Stop icon appears at the top of the display.



**Triggered icon**



**Freeze Waveform by Run/Stop Key** Press the *Run/Stop* key once. The waveform and signal acquisition freezes. To unfreeze, press the *Run/Stop* key again.



**Freeze Waveform by Single Trigger Mode** In the Single Trigger mode, the waveform always stays in the Stop mode, and is updated only when the *Single* key is pressed. When the *single* key is pressed, the Run/Stop key turns red. For details, see page 125.

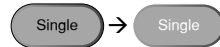

**Waveform Operation** The waveform can be moved or scaled in both Run and Stop mode, but in different manners. For details, see page 112 (Horizontal position/scale) and page 117 (Vertical position/scale).

## Horizontal Position/Scale

For more detailed configuration, see page 112.

Set Horizontal Position

The horizontal position knob moves the waveform left and right.

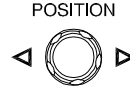

As the waveform moves, the memory bar on the top of the display indicates the portion of the waveform currently shown on the display and the position of the horizontal marker on the waveform.

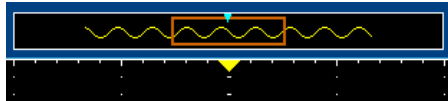

Position Indicator The horizontal position is shown at the bottom of the display grid to the right of H icon.



Select Horizontal Scale

To select the timebase (scale), turn the *TIME/DIV* knob; left (slow) or right (fast).

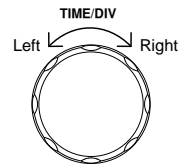

Range

1ns/div ~ 100s/div, 1-2-5 increments (1-2.5-5 for GDS350X).

The Time/Division rate is displayed to the left of the H icon at the bottom of the screen.



**Memory bar** The size of the memory bar changes to reflect the timebase and the section of the waveform that is displayed on screen.

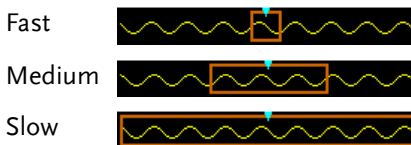

The Sample rate changes according to the time/division. For example the sample rate of the GDS-3304 at different time bases is shown below.

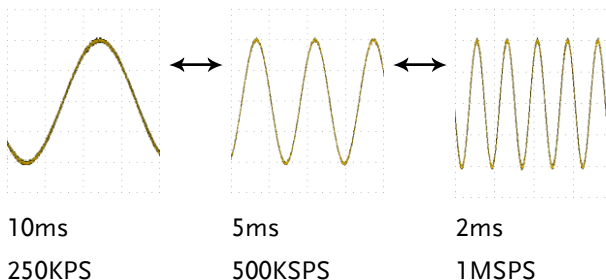

**Stop mode** In the Stop mode, the waveform size changes according to the scale.

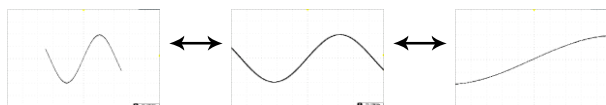

## Vertical Position/Scale

For more detailed configuration, see page117.

Set Vertical Position

To move the waveform up or down, turn the *vertical position knob* for each channel.

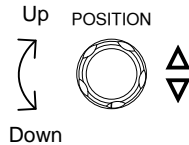

As the waveform moves, the vertical position of the cursor appears on the display.

**Position = 1.84mV**

Run/Stop mode

The waveform can be moved vertically in both Run and Stop mode.

Select Vertical Scale

To change the vertical scale, turn the *VOLTS/DIV* knob; left (down) or right (up).

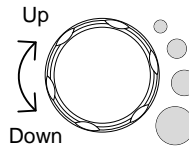



Range      2mV/div ~ 1V/div (50Ω/75Ω),  
2mV/div ~ 5V/div (1MΩ)  
1-2-5 increments

The vertical scale indicator for each channel on the bottom of the display changes accordingly.



## Split Window Mode

The split window mode is able to display and trigger each active channel independently. The split window mode is especially useful for signal comparisons. Reference waveforms can also be used in this mode. Most functions and features can be used with split screen mode except for the Math, XY display and Zoom mode.

- Enter Split Screen Mode
1. Activate each channel that is to be used in the split screen mode.  →  page 57
  2. Press the *Split Window* key to enter the split screen mode. 
  3. Split window mode appears. The number of windows depends on the number of active channels. 1-2 active channels will produce 2 split windows, while 3-4 active channels will produce 4 split windows.

The split window that has the active channel is shown with an orange border.

Example

4 channel split window

2 channel split window

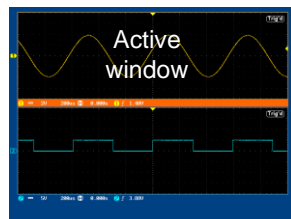
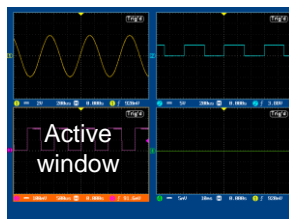

Select Active Channel

To select the active channel, press the corresponding split window key:

4 Window split screen:

2 window split screen:

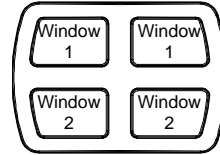
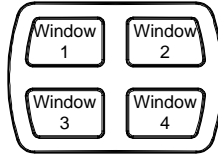

Reference Waveforms

Reference waveforms can also be used in this mode. Each reference waveform will be recalled to the corresponding split window number. I.e., Ref1 will be recalled to the first split window, Ref2 to the second window and so on.

Use Active Channel Settings

To return to full screen mode using the settings of the active channel, press the  button.

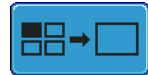

Exit Split Window mode

To exit split window mode, press the *Split Window* key again.











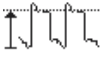
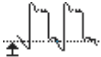
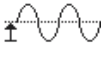

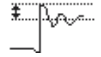
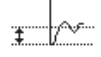
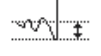

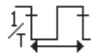
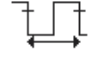
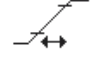
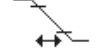
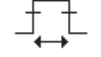
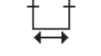
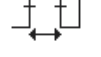

## Automatic Measurement

The automatic measurement function measures and updates major items for Voltage/Current, Time, and Delay type measurements.

## Measurement Items

	V/I Measurements	Time Meas.	Delay Meas.			
Overview	Pk-Pk		Frequency		FRR	
	Max		Period		FRF	
	Min		RiseTime		FFR	
	Amplitude		FallTime		FFF	
	High		+Width		LRR	
	Low		-Width		LRF	
	Average		Dutycycle		LFR	
	RMS				LFF	
	ROVShoot				Phase	
	FOVShoot					
	RPREShoot					
	FPREShoot					
Voltage/Current Measurement	Pk-Pk (peak to peak)		Difference between positive and negative peak voltage (= $V_{max} - V_{min}$ )			
	Max		Positive peak voltage			
	Min		Negative peak voltage			
	Amplitude		Difference between global high and global low voltage (= $V_{hi} - V_{lo}$ )			

	High		Global high voltage
	Low		Global low voltage
	Average		Averaged voltage of the first cycle
	RMS		RMS (root mean square) voltage
	ROVShoot		Rise overshoot voltage
	FOVShoot		Fall overshoot voltage
	RPREShoot		Rise preshoot voltage
	FPREShoot		Fall preshoot voltage
Time Measurement	Frequency		Frequency of the waveform
	Period		Waveform cycle time (=1/Freq)
	RiseTime		Rising time of the pulse (~90%)
	FallTime		Falling time of the pulse (~10%)
	+Width		Positive pulse width
	-Width		Negative pulse width
	Duty Cycle		Ratio of signal pulse compared with whole cycle =100x (Pulse Width/Cycle)

Delay Measurement	FRR		Time between: Source 1 first rising edge and Source 2 first rising edge
	FRF		Time between: Source 1 first rising edge and Source 2 first falling edge
	FFR		Time between: Source 1 first falling edge and Source 2 first rising edge
	FFF		Time between: Source 1 first falling edge and Source 2 first falling edge
	LRR		Time between: Source 1 first rising edge and Source 2 last rising edge
	LRF		Time between: Source 1 first rising edge and Source 2 last falling edge
	LFR		Time between: Source 1 first falling edge and Source 2 last rising edge
	LFF		Time between: Source 1 first falling edge and Source 2 last falling edge
Phase		The phase difference of two signals, calculated in degrees. $T1 \div T2 \times 360$ .	

## Individual Mode

Individual mode shows up to eight selected measurement items on bottom of the screen from any channel source.

Add Measurement Item

1. Press the *Measure* key.



2. Press *Add Measurement* from the bottom menu.



3. Choose either a *V/I*, *Time* or *Delay* measurement from the side menu.

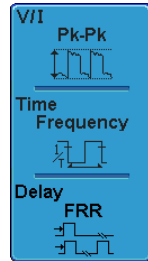

*V/I* (Voltage/Current) Pk-Pk, Max, Min, Amplitude, High, Low, Average, RMS, ROVShoot, FOVShoot, RPREShoot, FPREShoot

*Time* Frequency, Period, RiseTime, FallTime, +Width, -Width, Duty Cycle

*Delay* FRR, FRF, FFR, FFF, LRR, LRF, LFR, LFF, Phase

4. All individual measurements will be displayed in a window on the bottom of the screen. The channel number and channel color indicate the measurement source: yellow = CH1, blue = CH2, pink = CH3, green = CH4.



**Choose a Source** The channel source for measurement items can be set either before or when selecting a measurement item.

1. To set the source, press either the *Source1* or *Source2* key from the side menu and choose the source. Source 2 is only for delay measurements.

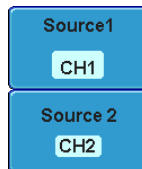

Range CH1, CH2, CH3, CH4

**Split Window Mode** Individual mode can be used with the split window mode. Each individual measurement will be displayed in the split window that houses the source of the measurement.

Delay measurements are not supported as only one source can be used for each measurement in split window mode.

## Remove Measurement

Individual measurements can be removed at any time using the Remove Measurement function.

**Remove Measurement Item**

1. Press the *Measure* key.
2. Press *Remove Measurement* from the bottom menu.
3. Choose which measurement window (if in split window mode) the item is located in (*Window 1~4*) and use the variable knob to remove an item.

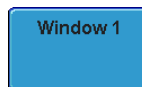

**Remove All Items** Press *Remove All* to remove all the measurement items in full screen mode, or to remove all the measurement items for the active window in split screen mode.

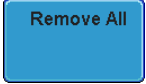
 A blue rectangular button with rounded corners containing the text "Remove All".

## Gated mode

Some automatic measurements can be limited to a “gated” area between cursors. Gating is useful for measuring a magnified waveform or when using a fast time base. The Gated mode has three possible configurations: Off (Full Record), Screen and Between Cursors.

---

**Set Gating Mode** 1. Press the *Measure* key.

 A grey rounded rectangular button with the text "Measure".

2. Press *Gating* from the bottom menu.

 A blue rectangular button with rounded corners. The text "Gating" is at the top, and "Off" is in a white box at the bottom.

3. Choose one of the gating modes from the side menu: *Off (Full Record)*, *Screen*, *Between Cursors*

 A blue rectangular menu with rounded corners. It has three options: "Off (Full Record)" (highlighted with a white background), "Screen", and "Between Cursors".

**Cursors On Screen**

If *Between Cursors* is selected, the cursor positions can be edited by using the cursor menu.

Page 76

## Display All mode

Display All mode shows and updates all items from Voltage and Time type measurements.

View Measurement Results

1. Press the *Measure* key.

Measure

2. Press *Display All* from the bottom menu.

Display All  
OFF

3. Choose a channel (*CH1, CH2, CH3, CH4*) from the side menu to display auto measurement items.

Note: only the channels that are activated are available.

4. The results of Voltage and Time type measurements appear on the display.

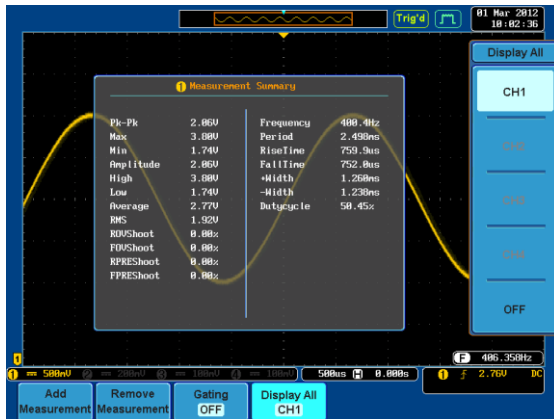

Remove Measurements

To remove the measurement results, press *OFF*.

OFF

Delay  
Measurements

Delay type measurement is not available in this mode as only one channel is used as the source. Use the Individual measurement mode (page 71) instead.

# Cursor Measurement

Horizontal or vertical cursors are used to show the position and values of waveform measurements and math operation results. These results cover voltage, time, frequency and other math operations. When the cursors (horizontal, vertical or both) are activated, they will be shown on the main display unless turned off. (page 111).

## Use Horizontal Cursors

Panel Operation/ Range 1. Press the *Cursor* key once.

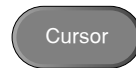

2. Press *H Cursor* from the bottom menu.

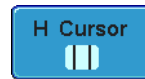

3. Press H Cursor repeatedly to toggle the cursor type.

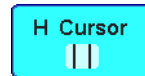

Range

- |   |   |  |
|---|---|--|
|   | ⋮ | Left cursor (1) movable, right cursor position fixed |
| ⋮ |   | Right cursor (2) movable, left cursor position fixed |
|   |   | Left and right cursor (1+2) movable together         |

4. The cursor position information appears on the top left hand side of the screen

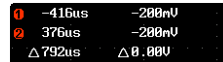

- Cursor 1 Time, Voltage/Current
- Cursor 2 Time, Voltage/Current
- △ Delta (difference between cursors)

- Use the *Variable knob* to move the movable cursor(s) left or right.

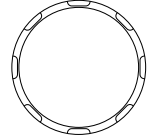

Example

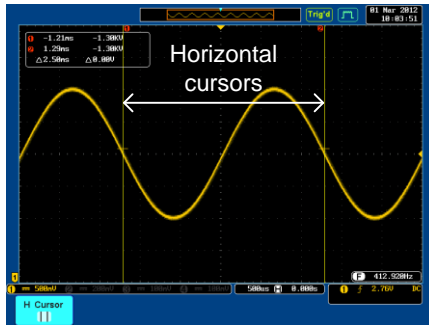

FFT Math

FFT Math has different content. For FFT math details, see page 85.

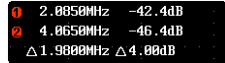

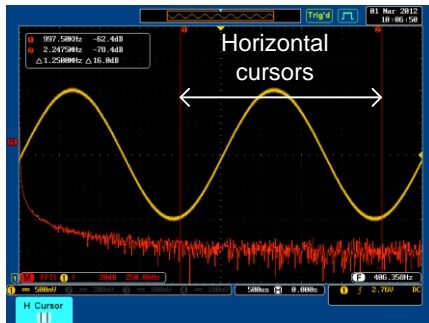

- Cursor 1 Frequency, dB/V
- Cursor 2 Frequency, dB/V
- Δ Delta (difference between cursors)

Example

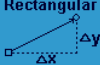
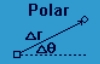

XY Mode

XY mode cursors measure a number of X by Y measurements.

1 (X) Versus 2 (Y)	1 2 Δ		
	t:	250us	562us
<b>Rectangular</b> 	x: -9.60V y: -9.60V	400mV 400mV	18.0V 18.0V
<b>Polar</b> 	r: 13.5V θ: -135°	565mV 45.0°	14.1V 45.0°
<b>Product</b> 	x×y:	92.10V 160mV	1800V 1800V
<b>Ratio</b>	y÷x:	1.00V/V 1.00V/V	1.00V/V 1.00V/V

Cursor 1 Time, rectangular, polar co-ordinates, product, ratio.

Cursor 2 Time, rectangular, polar co-ordinates, product, ratio.

Δ Delta (difference between cursors)

Example

Horizontal cursors

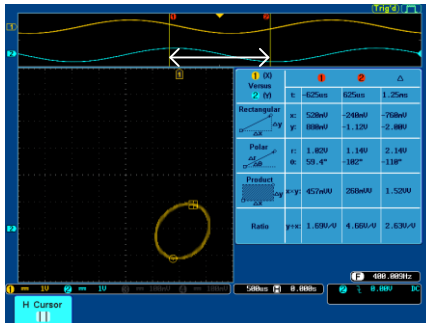

## Use Vertical Cursors

Panel Operation/ Range 1. Press the *Cursor* key twice.



2. Press *V Cursor* from the bottom menu.

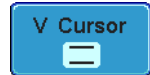

3. Press *V Cursor* repeatedly to toggle the cursor type.

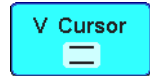

Range

- Upper cursor movable, lower cursor position fixed
- Lower cursor movable, upper cursor position fixed
- Upper and lower cursor movable together

4. The cursor position information appears on the top left hand side of the screen.

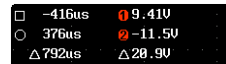

- , ○ Time: cursor 1, cursor 2
- ①, ② Voltage/Current: cursor1, cursor2
- △ Delta (difference between cursors)

5. Use the *Variable knob* to move the cursor(s) up or down.

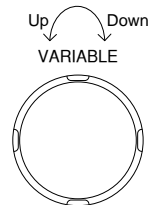

Example

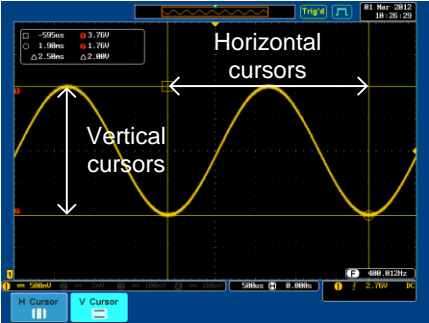

FFT Math

The FFT Math has different content. For FFT math details, see page 85.



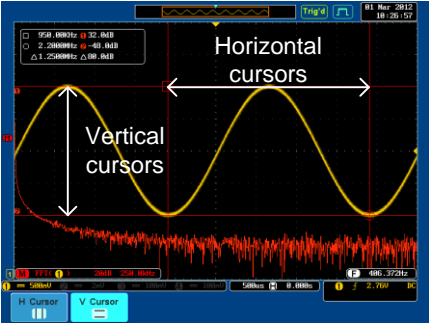

- , ○ Frequency/Time: cursor1, cursor2
- ①, ② dB/V: cursor1, cursor2
- △ Delta (difference between cursors)

Example

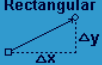
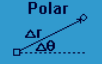

XY Mode

XY mode cursors measure a number of X by Y measurements.

1 (X) Versus 2 (Y)	1 2 Δ		
	t:		
<b>Rectangular</b> 	x: -1.88U y: 2.00U	120nU 0.00U	2.00U -2.00U
<b>Polar</b> 	r: 2.74U θ: 133°	120nU 0.00°	2.82U -45.0°
<b>Product</b> 	x×y: -3.76U	0.00U	-4.00U
<b>Ratio</b>	y÷x: -1.06U/U	0.00U/U	-1.00U/U

- Cursor 1 Rectangular, polar co-ordinates, product, ratio.
- Cursor 2 Rectangular, polar co-ordinates, product, ratio.
- Δ Delta (difference between cursors)

Example

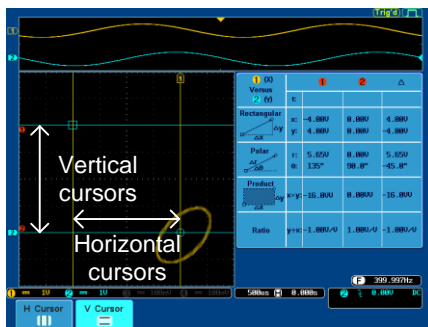

# Math Operation

## Overview

**Background** Math operation runs addition, subtraction, multiplication, division or FFT using the input signals or reference waveforms (Ref1~4) and shows the result on the display. The resulted waveform characteristics can be measured using the cursors.

**Addition (+)** Adds the amplitude of two signals.

Source CH1~4, Ref1~4

**Subtraction (-)** Extracts the amplitude difference between two signals.

Source CH1~4, Ref1~4

**Multiplication (×)** Multiplies the amplitude of two signals.

Source CH1~4, Ref1~4

**Division (÷)** Divides the amplitude of two signals.

Source CH1~4, Ref1~4

**FFT** Runs FFT calculations on a signal. Four types of FFT windows are available: Hanning, Hamming, Rectangular, and Blackman.

Source CH1~4, Ref1~4



**Hanning FFT Window** Frequency resolution Good

Amplitude resolution Not good

Suitable for... Frequency measurement on periodic waveforms

Hamming FFT Window	Frequency resolution	Good
	Amplitude resolution	Not good
	Suitable for...	Frequency measurement on periodic waveforms
Rectangular FFT Window	Frequency resolution	Very good
	Amplitude resolution	Bad
	Suitable for...	Single-shot phenomenon (this mode is the same as having no window at all)
Blackman FFT Window	Frequency resolution	Bad
	Amplitude resolution	Very good
	Suitable for...	Amplitude measurement on periodic waveforms

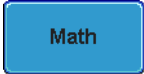
### Addition/Subtraction/Multiplication/Division

- Panel Operation
1. Press the *Math* key. 
  2. Press the *Math* key on the lower bezel. 
  3. Select *Source 1* from the side menu 

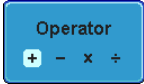
Range CH1~4, Ref~4
  4. Press *Operator* to choose the math operation. 

Range +, -, x, ÷

5. Select *Source 2* from the side menu.

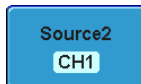

Range CH1~4, Ref~4

6. The math measurement result appears on the display. The vertical scale of the math waveform appears at the bottom of the screen.



From left: Math function, source1, operator, source2, Unit/div

Example

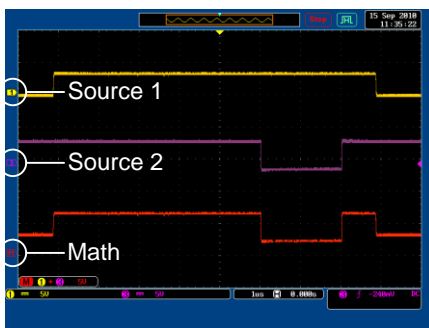

**Position and Unit** To move the math waveform vertically, press the *Position* key from the side menu and use the variable knob to set the position.



To change the unit/div settings, press *Unit/div*, then use the variable knob change the unit/div.

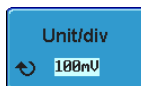





Range 2mV~1kV (1-2-5 steps)

**Turn Off Math** To turn off the Math result from the display, press the *Math* key again.



## FFT

- Panel Operation
- Press the *Math* key. 
  - Press *FFT* from the bottom menu. 
  - Select the *Source* from the side menu.   
Range CH1~4, Ref~4
  - Press the *Vertical Units* key from the side menu to select the vertical units used.   
Range Linear RMS, dBV RMS
  - Press the *Window* key from the side menu and select the window type.   
Range Hanning, Hamming, Rectangular, and Blackman.
  - The FFT result appears. For FFT, the horizontal scale changes from time to frequency, and the vertical scale from voltage/current to dB/RMS.

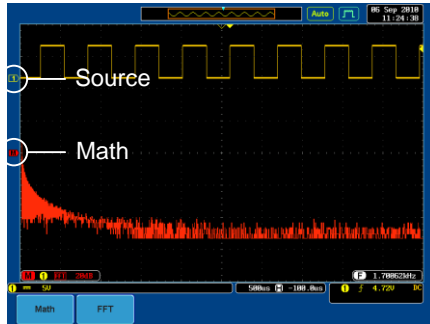

**Position and Unit** To move the FFT waveform vertically, press *Position* and use the variable knob.

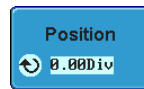

Range -12.00 Div ~ +12.00 Div

To select the vertical scale of FFT waveform, press *Unit/div* and use the variable knob.

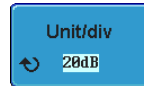

Range 2mV~1kV RMS, 1~20 dB

**Clear FFT** To clear the FFT result from the display, press the *Math* key again.



# Applications

## Overview

---

**Background**      The APP. function allows different applications to be run. Applications can be downloaded from the GW Instek website.

---

**Included Applications**      **GO-NOGO**      The GO\_NOGO application can be used to set threshold boundaries for input signals. GO-NOGO checks if a waveform fits inside a user-specified maximum and minimum amplitude boundary (template).

## Running Applications

---

**Background**      The APP. function can host a number of different applications that can be downloaded from the GW Instek website.

---

**Panel Operation**      1. Press the *Test* key.



2. Press *APP.* from the bottom menu.



3. Scroll through each Application using the Variable knob.



4. Select an application by pressing the *Select* key *twice*.

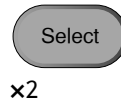

## Uninstalling Applications

**Background** Any APP. function can be easily uninstalled using the *Uninstall* function.

**Panel Operation** 1. Press the *Test* key.



2. Press *APP.* from the bottom menu.



3. Scroll through each Application using the Variable knob.



4. When the desired application is highlighted, press *Uninstall* to begin the uninstallation. Press again to confirm.

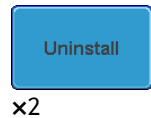

## Using Go\_NoGo

### Background

The Go-NoGo test checks if a waveform fits inside a user-specified maximum and minimum boundary (boundary template). Boundary templates are automatically created from a source channel. Boundary tolerance and violation conditions can be set.

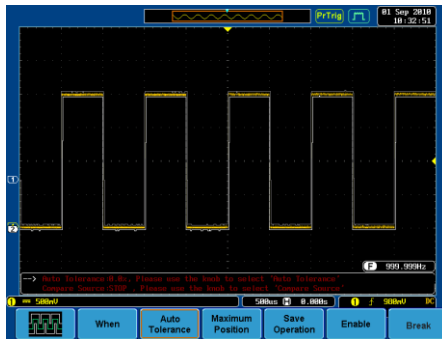

Choose the Go\_NoGo application from the APP. menu. See page 87.

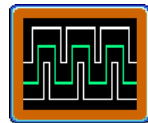

### Go-NoGo Conditions

Select the Go-NoGo conditions (When) and actions when a Go-NoGo condition has been met (Violating).

1. Press *When* from the bottom menu and use the Variable knob to select the When condition.



**When** Exits: Sets the NoGo condition to when the input signal exceeds the limit boundary.

Enters: Sets the NoGo condition to when the input signal stays within the limit boundary.

2. Press *When* again to change the menu to *Violating*. Use the Variable knob to choose the action for when a violation occurs.

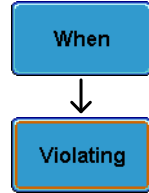

**Violating Stop:** The waveform will be frozen.

**Stop\_Beep:** The waveform will be frozen and a beep will be output.

**Continue:** Ignore the violation.

**Continue\_Beep:** Output a beep, but continue to monitor the signal.

Source

1. Press *Compare Source* from the bottom menu and use the Variable knob to select the source.



Source CH1, CH2, CH3, CH4

Tolerance Boundary

1. To set a tolerance, press *Compare Source* again to toggle the menu to *Auto Tolerance*. Use the Variable knob to choose the tolerance as a percentage.

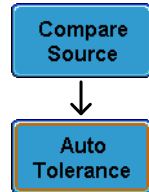

**Violating** 0.4% ~ 40% (.4% steps)

**Note** If a tolerance is set, the maximum and minimum boundary is reset as the tolerance boundary.

Maximum and Minimum

1. To set a maximum and minimum boundary, press *Minimum Position* from the bottom menu and use the Variable knob to select the absolute minimum position.



Position Voltage division range

2. Press *Minimum Position* again to toggle the menu to Maximum Position. Choose the maximum position.



Position Voltage division range

Note If a maximum and minimum boundary is set, the tolerance will be disabled.

Save Boundary Limits

1. Select a *Maximum Position* or a *Tolerance* from the lower menu.
2. To save the Go-NoGo test parameters, press *Save Operation*. The Maximum position will be saved to R1. The tolerance waveforms will be saved to R1 and R2.
3. If a *Maximum Position* was saved, repeat the save procedure for *Minimum Position*. The Minimum position waveform will be saved to R2.



Start Go-NoGo

Press *Enable* to start the Go-NoGo test. The Enable button will change to Disable. Pressing *Disable* will stop the Go-NoGo test and toggle the button back to Enable.

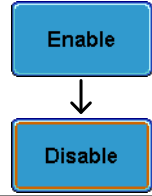

Exit the Application

To exit the application, press *Break*.



Using the Go-NoGo Output

To output the Go-NoGo results to an external device, the Go-NoGo rear panel terminal (open collector) can be used. The Go-NoGo terminal will output a positive pulse each time a NoGo violation has occurred for a minimum of 10us. The voltage of the pulse depends on the external pull-up voltage.



The line out socket can also be used to connect directly to a buzzer.



Timing Diagram

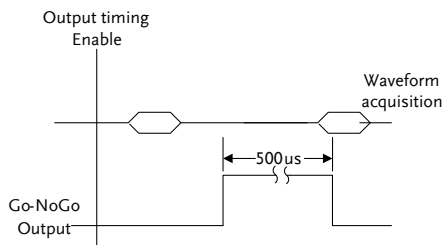

When a No-Go violation occurs the Go-NoGo output will go from a low level to a high level for a minimum of 500us.

Circuit Diagram

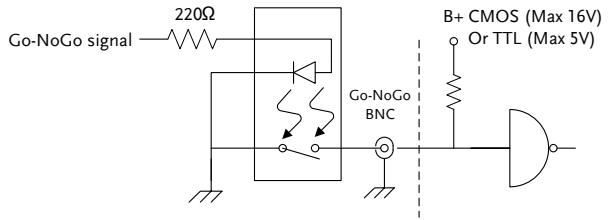

---

## Power Analysis

Power analysis provides automatic measurement for a number of advanced measurement types such as power quality, harmonics, ripple and inrush current. The Power analysis software is an optional software module, for details please see page 192. Please see the Power Analysis manual for more details on using the power analysis software.

### Power Analysis Overview

---

Power Quality	Power quality measures the power of a signal using the measured voltage and current of a signal.
Harmonics	The harmonics function shows signal harmonics up to the 400th harmonic. Harmonic tests can be user defined and common harmonic standards such as IEC 61000-3-2 can also be tested for.
Ripple	The ripple function calculates the ripple and noise of the waveform.
Inrush Current	The inrush function automatically calculates the first peak and second peak inrush current.

## Serial Bus

The serial bus trigger and decode software includes support for 3 common serial interfaces, SPI (4 channel models only), UART and I<sup>2</sup>C. Each interface is fully configurable to accommodate a wide range of protocol variation.

Each input can be displayed as binary or hexadecimal. An event table can also be created to aid in debugging.

Note that the Serial bus trigger and decode software is an optional extra. An activation key is required to activate the software, for details please see page 192. Please see the Serial Bus Decode manual for more details on using the serial bus software.

### Serial Bus Overview

---

UART	<p>Universal Asynchronous Receiver Transmitter. The UART bus is able to accommodate a wide range of various common UART serial communications.</p> <p>The UART serial bus software is suitable for a number of RS-232 protocol variants.</p> <p>Inputs Tx, Rx</p> <p>Threshold Tx, Rx</p> <p>Configuration Baud rate, Parity, Packets, End of packets, Input polarity</p> <p>Trigger On Tx Start Bit, Rx Start Bit, Tx End of Packet, Rx End of Packet, Tx Data, Rx Data, Tx Parity Error, Rx Parity Error</p>
------	--

---

I <sup>2</sup> C	<p>Inter Integrated Circuit is a two line serial data interface with a serial data line (SDA) and serial clock line (SCLK). The R/W bit can be configured.</p> <p>Inputs SCLK, SDA</p>
------------------	--

---

Threshold	SCLK, SDA
Configuration	Addressing mode, Read/Write in address
Trigger On	Start, Repeat Start, Stop, Missing Ack, Address, Data, Address/Data

---

SPI                    The SPI (Serial Interface Peripheral) bus is fully configurable to accommodate the wide variety of SPI interfaces. This bus is only available on 4 channel models.

Inputs	SCLK, SS, MOSI, MISO
Threshold	SCLK, SS, MOSI, MISO
Configuration	SCLK edge, SS logic level, Word size, Bit order
Trigger On	SS Active, MOSI, MISO, MOSI&MISO

# CONFIGURATION

<b>Acquisition.....</b>	<b>100</b>
Select Acquisition Mode.....	100
Show Waveform in XY Mode.....	102
Set the Sampling Mode.....	104
Real time vs Equivalent Time Sampling Mode.....	105
<b>Display.....</b>	<b>106</b>
Display Waveform as Dots or Vectors.....	106
Set the Level of Persistence.....	107
Set the Intensity Level.....	107
Set the Waveform Intensity Type.....	109
Select Display Graticule.....	110
Freeze the Waveform (Run/Stop).....	111
Turn Off Menu.....	111
<b>Horizontal View.....</b>	<b>112</b>
Move Waveform Position Horizontally.....	112
Select Horizontal Scale.....	113
Select Waveform Update Mode.....	114
Zoom Waveform Horizontally.....	115
<b>Vertical View (Channel).....</b>	<b>117</b>
Move Waveform Position Vertically.....	117
Select Vertical Scale.....	117
Select Coupling Mode.....	118
Set the Impedance.....	119
Invert Waveform Vertically.....	119
Limit Bandwidth.....	120
Expand by Ground/Center.....	121
Select Probe Type.....	122
Select Probe Attenuation Level.....	123
Set the Deskew.....	124

<b>Trigger .....</b>		<b>125</b>
	Trigger Type Overview .....	125
	Trigger Parameter Overview .....	127
	Setup Holdoff Level .....	131
	Setup Trigger Mode .....	132
	Using the Edge Trigger .....	132
	Using Advanced Delay Trigger .....	134
	Using Pulse Width Trigger.....	135
	Using Video Trigger .....	137
	Pulse Runt trigger.....	138
	Using Rise and Fall Trigger.....	140
<b>System Info / Language / Clock.....</b>		<b>142</b>
	Select Menu Language.....	142
	View System Information .....	142
	Erase Memory .....	143
	Set the Buzzer Volume.....	144
	Set Date and Time .....	144

## Acquisition

The Acquisition process samples the analog input signals and converts them into digital format for internal processing.

### Select Acquisition Mode

---

Background	The acquisition mode determines how the samples are used to reconstruct a waveform.
Sample	This is the default acquisition mode. Every sample from each acquisition is used.
Peak detect	Only the minimum and maximum value pairs for each acquisition interval (bucket) are used. This mode is useful for catching abnormal glitches in the signal.
Hi Resolution	Performs boxcar averaging on the samples. This reduces white noise and increases the vertical resolution of the waveform.
Average	Multiple acquired data is averaged. This mode is useful for drawing a noise-free waveform. To select the average number, use the Variable knob.  Average number: 2, 4, 8, 16, 32, 64, 128, 256

Panel Operation 1. Press the *Acquire* key.

 A dark grey, rounded rectangular button with the word "Acquire" written in white text in the center.

2. To set the Acquisition mode, press *Mode* on the bottom menu.



3. Select an acquisition mode from the side menu.

Mode	Sample, Peak Detect, Hi Resolution, Average
Average sample	2, 4, 8, 16, 32, 64, 128, 256



Example

Sample

Peak Detect

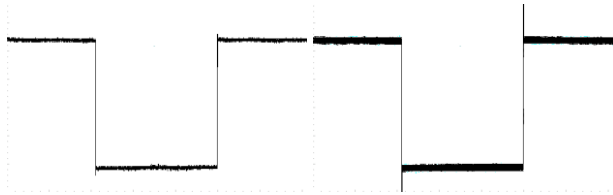

High Resolution

Average (256 times)

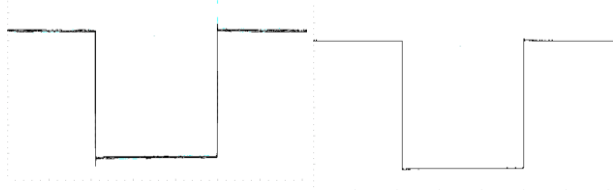

## Show Waveform in XY Mode

**Background** The XY mode maps the voltage of channel 1 to the voltage of channel 2. In 4 channel models, the voltage of channel 3 is mapped to the voltage of channel 4. This mode is useful for observing the phase relationship between waveforms.

Reference waveforms can also be used in XY mode. Ref1 is mapped to Ref2 and Ref3 is mapped to Ref4. Using the reference waveforms is the same as using the channel input waveforms.

### Connection

1. Connect the signals to Channel 1 (X-axis) and Channel 2 (Y-axis) or Channel 3 (X2-axis) and Channel 4 (Y2-axis).

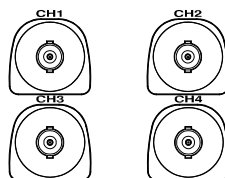

2. Make sure a channel pair is active (CH1&CH2 or CH3&CH4). Press the Channel key if necessary. A channel is active if the channel key is lit.



### Panel Operation

1. Press the *Acquire* menu key.



2. Press XY from the bottom menu.

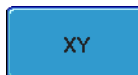

3. Choose *Triggered XY* from the side menu.



X-Y mode is split into two windows. The top window shows the signals over the full time range. The bottom window shows XY mode.

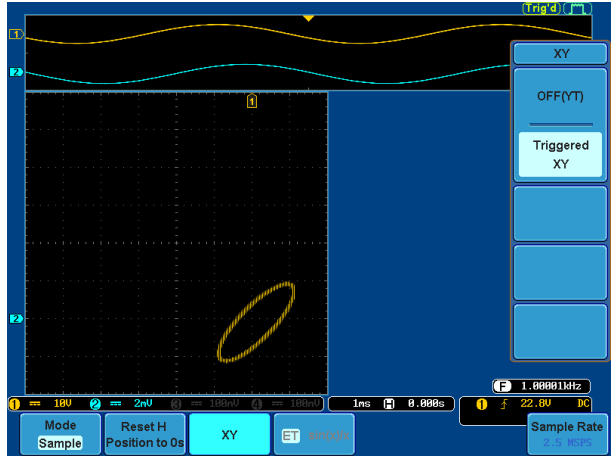

To move the X Y waveform position, use the vertical position knob: Channel 1 knob moves the X Y waveform horizontally, Channel 2 knob moves the X Y waveform vertically. Similarly, the X2 and Y2 axis can be positioned using the channel 3 and channel 4 vertical position knobs.

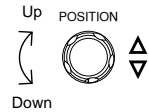

The horizontal position knob and Time/Div knob can still be used under the XY mode.

Turn Off XY Mode To turn off XY mode, choose *OFF (YT)* mode.

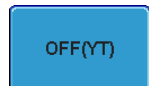

XY Mode

Cursors can be used with XY mode. See the Cursor chapter for details.

Page 76

## Set the Sampling Mode

**Background** The GDS-3000 has two types of sampling modes: ET (Equivalent Time) and  $\text{Sin}(x)/x$  interpolation. Equivalent time sampling is able to achieve a sample rate of 100GSa/s when sampling periodic waveforms.  $\text{Sin}(x)/x$  interpolation uses a sinc interpolation formula to reconstruct a continuous signal between sampled points.

**Panel Operation** 1. Press the *Acquire* key.



2. Press the *ET/sin(x)/x* key on the bottom menu to toggle between equivalent time sampling (ET) and  $\text{sin}(x)/x$  interpolation.



The sampling rate will be shown on the bottom right-hand corner

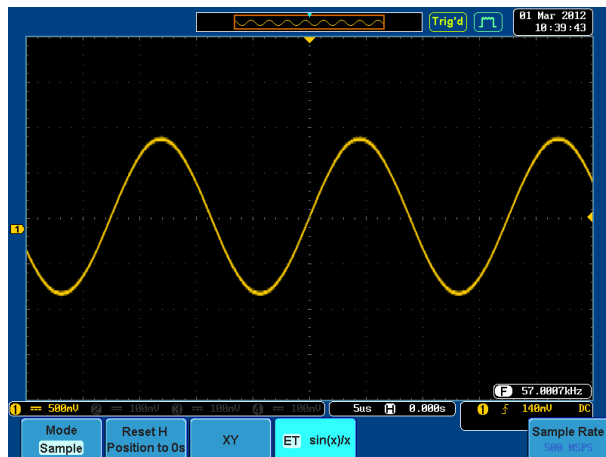

## Real Time vs Equivalent Time Sampling Mode

**Background**      The sampling mode on the GDS-3000 can be switched between two sampling modes: Real-time and Equivalent-time. The number of active channels in operation will determine the sampling rate of the DSO. The sampling rate and mode depends on the number of active channels and whether the oscilloscope model has 2 or 4 channels.

<b>Parameter</b>	<b>Real-time sampling</b>	One sample of data is used to reconstruct a single waveform. Real-time sampling is used when the time base is relatively slow or if single shot events need to be captured.
	<b>Equivalent-time sampling</b>	Sampled data is accumulated a number of times to reconstruct a single waveform. This increases the sampling rate, but can only be used for repetitive signals. This mode is usually used when the time base is too fast for real-time sampling.

## Display

The Display menu defines how the waveforms and parameters appear on the main LCD display.

### Display Waveform as Dots or Vectors

---

**Background** When the waveform is displayed on screen, it can be displayed as dots or vectors.

---

**Panel Operation** 1. Press the *Display* menu key.

 A grey, rounded rectangular button with the word "Display" in white text.

2. Press *Dot Vector* to toggle between Dot and Vector mode.

 A blue rectangular button with rounded corners. It contains the text "Dot" in white and "Vector" in white, with a white rectangular highlight over the "Vector" text.

**Range**      **Dots**      Only the sampled dots are displayed.

**Vectors**      Both the sampled dots and the connecting line are displayed.

---

**Example:**

Vectors (square wave)

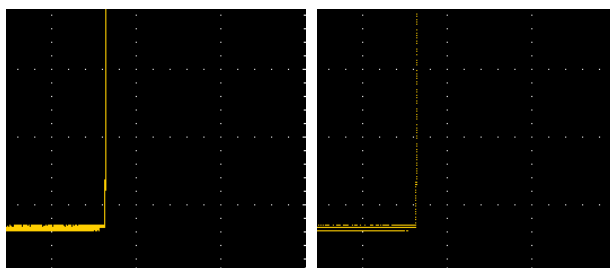

Dots (square wave)



## Set the Level of Persistence

**Background** The persistence function allows the GDS-3000 to mimic the trace of a traditional analog oscilloscope. A waveform trace can be configured to “persist” for designated amount of time.

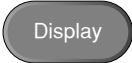
**Panel Operation**

1. Press the *Display* menu key. 
2. To set the persistence time, press the *Persistence* menu button on the bottom bezel. 
3. Use the variable knob to select a persistence time. 

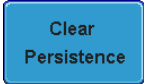

Time      Auto, 100ms~10s, Infinite, VPO Off

**Clear** To clear persistence, press *Clear Persistence*. 

## Set the Intensity Level

**Background** The intensity level of a signal can also be set to mimic the intensity of an analog oscilloscope by setting the digital intensity level.

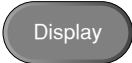
**Panel Operation**

1. Press the *Display* menu key. 
2. Press *Intensity* from the bottom menu. 

Waveform Intensity      3. To set the waveform intensity, press *Waveform Intensity* and edit the intensity.

Range      0~100%

Graticule Intensity      4. To set the graticule intensity, press *Graticule Intensity* from the side menu and edit the intensity value.

Range      10~100%

Example

Waveform Intensity 0%

Waveform Intensity 100%

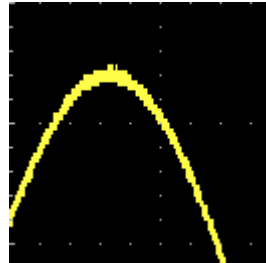
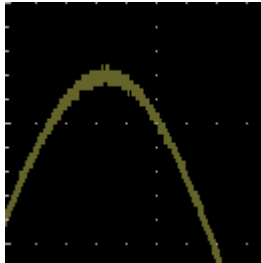

Graticule Intensity 10%

Graticule Intensity 100%

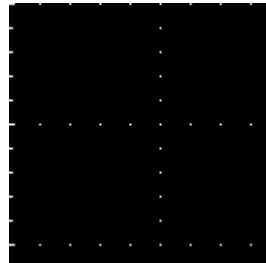
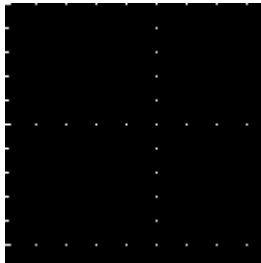

## Set the Waveform Intensity Type

**Background**      The intensity gradient of a signal can be set to grayscale or color. If intensity is set to color, the intensity gradient is analogous to a thermal color gradient where high intensity areas are colored red and low intensity areas are colored blue.

**Panel Operation**    1. Press the *Display* menu key.



2. Press *Waveform* from the bottom menu to toggle the intensity type.



Range      Gray, Color

**Example**

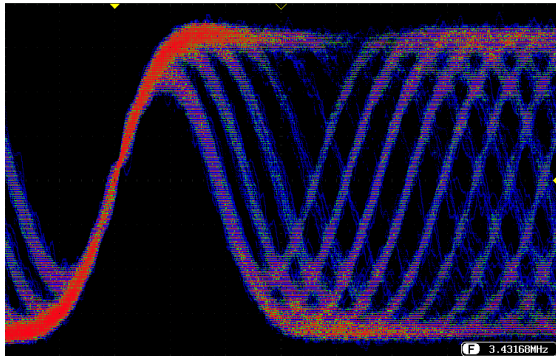

## Select Display Graticule

---

Panel Operation 1. Press the *Display* menu key.

A grey, rounded rectangular button with the word "Display" in white text.

2. Press *Graticule* from the bottom menu.

A blue rectangular button with a thin black border and the word "Graticule" in white text.

3. From the side menu choose the graticule display type.



*Full*: Shows the full grid; X and Y axis for each division.



*Grid*: Show the full grid without the X and Y axis.



*Cross Hair*: Shows only the center X and Y frame.



*Frame*: Shows only the outer frame.

## Freeze the Waveform (Run/Stop)

For more details about Run/Stop mode, see page 59.

- Panel Operation
1. Press the *Run/Stop* key. To unfreeze the waveform, press the *Run/Stop* key again.
  2. The waveform and the trigger freezes. The trigger indicator on the top right of the display shows Stop.



## Turn Off Menu

- Panel Operation
1. Press the *Menu Off* key below the side menu keys to reduce a menu. The menu key needs to be pressed each time to reduce one menu.

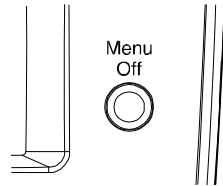

See page 32 for more information.

## Horizontal View

This section describes how to set the horizontal scale, position, and waveform display mode.

### Move Waveform Position Horizontally

**Panel Operation** The horizontal position knob moves the waveform left/right.



As the waveform moves, a position indicator on the top of the display indicates the horizontal position of the waveform in memory.

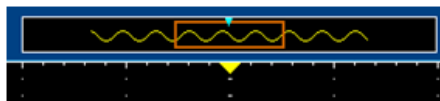

**Reset Horizontal Position** 1. To reset the horizontal position, press the Acquire key and then press *Reset H Position to 0s* from the bottom menu.

Acquire

Reset H  
Position to 0s

**Run Mode** In Run mode, the memory bar keeps its relative position in the memory since the entire memory is continuously captured and updated.

## Select Horizontal Scale

**Select Horizontal Scale** To select the timebase (scale), turn the TIME/DIV knob; left (slow) or right (fast).

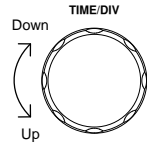

**Range** 1ns/div ~ 100s/div, 1-2-5 increment (1-2.5-5 for GDS-350X)

The timebase indicator updates as the TIME/DIV is adjusted.

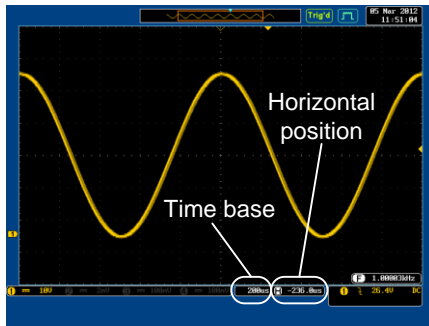

**Run Mode** In Run mode, the memory bar and waveform size keep their proportion. When the time base becomes slower, roll mode is activated (if trigger is set to Auto).

**Stop Mode** In Stop mode, the waveform size changes according to the scale.

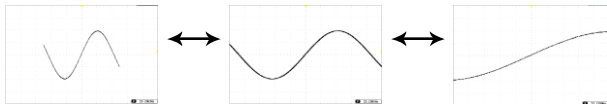

## Select Waveform Update Mode

Background	The display update mode is switched automatically or manually according to the timebase and trigger.
Normal	<p>Updates the whole displayed waveform at once. Automatically selected when the timebase (sampling rate) is fast.</p> <p>Timebase    <math>\leq 50\text{ms/div}</math> (<math>\geq 50\text{kSa/s}</math>)</p> <p>Trigger      all modes</p>
Roll Mode	<p><b>Roll</b> Updates and moves the waveform gradually from the right side of the display to the left. Automatically selected when the timebase (sampling rate) is slow.</p> <p>Timebase    <math>\geq 100\text{ms/div}</math>  <math>(\leq 25\text{kSa/S})</math> 350MHz models  <math>(\leq 20\text{kSa/S})</math> 500MHz models</p> <p>Trigger      all modes</p>

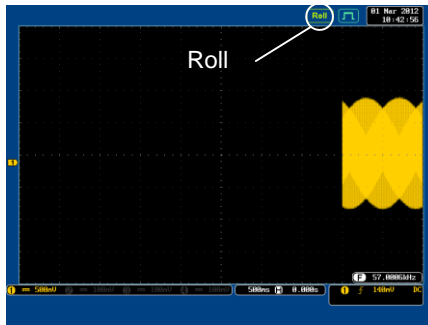

Select Roll Mode Manually 1. Press the *Trigger Menu* key.



2. Press *Mode* from the bottom menu and select *Auto (Untriggered Roll)* from the side menu.



## Zoom Waveform Horizontally

**Background** When in Zoom mode the screen is split into 2 sections. The top of the display shows the full record length, with the bottom of the screen showing the normal view.

**Panel Operation** 1. Press the *Zoom* key.

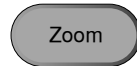

2. The Zoom mode screen appears.

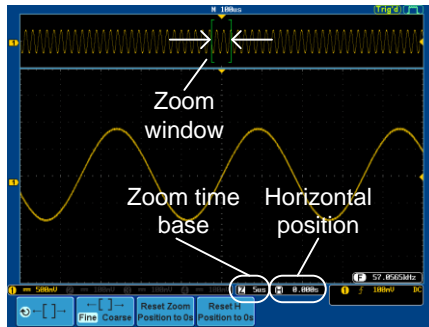

**Horizontal Navigation** To scroll the waveform left or right, use the *Horizontal Position* knob.



To reset the horizontal position, press *Reset H Position to 0s*.



**Zoom** To increase the zoom range, use the *TIME/DIV* knob.

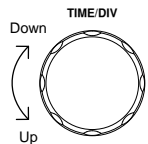

The zoom time base (Z) at the bottom of the screen will change accordingly.



Move the Zoom Window

Use the *Variable* knob to pan the zoom window horizontally.

Left  Right  
VARIABLE

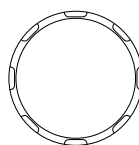

To reset the Zoom position, press  
*Reset Zoom Position to 0s.*



Scroll Sensitivity

To alter the scrolling sensitivity of the Zoom Window, press the  $\leftarrow[\ ]\rightarrow$  key to toggle the scrolling sensitivity.

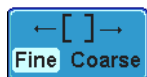

Sensitivity Fine, Coarse

Exit

To go back to the original view, press the *Zoom* key again.



## Vertical View (Channel)

This section describes how to set the vertical scale, position, and coupling mode.

### Move Waveform Position Vertically

Panel Operation

1. To move the waveform up or down, turn the *vertical position* knob for each channel.
2. As the waveform moves, the vertical position of the cursor appears at the bottom half of the display.

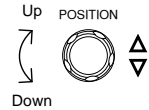

Position = 0.00V

View or Reset  
Vertical Position

1. Press a channel key. The vertical position is shown in the  $\text{Position} / \downarrow \text{Set to 0}$  soft key.
2. To change the position, press  $\text{Position} / \downarrow \text{Set to 0}$  to reset the vertical position or turn the *vertical position* knob to the desired level.



Run/Stop Mode

The waveform can be moved vertically in both Run and Stop mode.

### Select Vertical Scale

Panel Operation

To change the vertical scale, turn the VOLTS/DIV knob; left (down) or right (up).

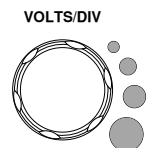

The vertical scale indicator on the bottom left of the display changes accordingly for the specific channel.

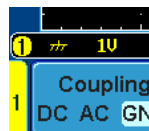

Range      2mV/div ~ 1V/div (50Ω/75Ω),  
2mV/div ~ 5V/div (1MΩ). 1-2-5  
increments

Stop Mode      In Stop mode, the vertical scale setting can be changed.

## Select Coupling Mode

Panel Operation    1. Press a *channel* key.



2. Press *Coupling* repeatedly to toggle the coupling mode for the chosen channel.

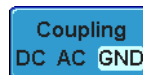

Range

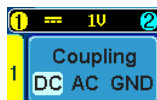

DC coupling mode. The whole portion (AC and DC) of the signal appears on the display.

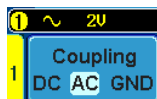

AC coupling mode. Only the AC portion of the signal appears on the display. This mode is useful for observing AC waveforms mixed with DC signals. AC coupling is not available with input impedances of 75Ω or 50Ω.

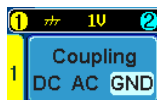

Ground coupling mode. The display shows only the zero voltage level as a horizontal line.

Example Observing the AC portion of the waveform using AC coupling

DC coupling

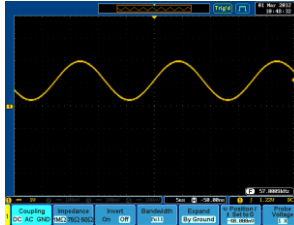

AC coupling

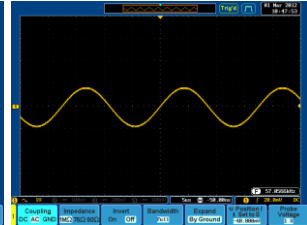

## Set the Impedance

Panel Operation 1. Press the *Channel* key.



2. Press *Impedance* repeatedly to toggle between the impedance settings.



Impedance 1MΩ, 75Ω, 50Ω

## Invert Waveform Vertically

Panel Operation 1. Press the *Channel* key.



2. Repeatedly press *Invert* to toggle Invert On or Off.

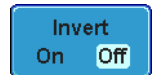

## Limit Bandwidth

**Background** Bandwidth limitation puts the input signal into a selected bandwidth filter.

This function is useful for cutting out high frequency noise to see a clear waveform shape.

The bandwidth filters available are dependent on the bandwidth of the oscilloscope model.

**Panel Operation** 1. Press the *Channel* key.



2. Press *Bandwidth* from the bottom menu.



3. Choose a bandwidth\* from the side menu (depending on the bandwidth of the oscilloscope).

Range	150MHz models: Full, 20MHz
	250MHz models: Full, 20MHz, 100MHz
	350MHz models: Full, 20MHz, 100MHz, 200MHz
	500MHz models: Full, 20MHz, 100MHz, 200MHz, 350MHz

**Note** When the input impedance is set to 75Ω, the bandwidth is limited to a maximum of 150MHz.

Example

BW Full

BW Limit 20MHz

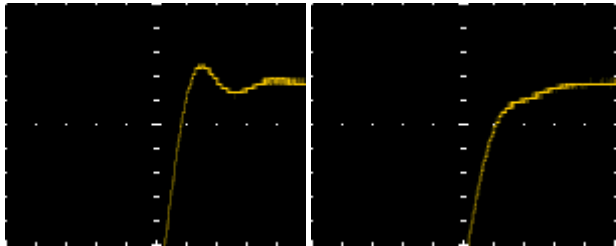

## Expand by Ground/Center

---

Background

When the voltage scale is changed, the Expand function designates whether the signal expands from the center of the signal or from the signal ground level. Expand by center can be used to easily see if a signal has a voltage bias. Expand by ground is the default setting.

Panel Operation

1. Press a *channel* key.



2. Press *Expand* repeatedly to toggle between expand *By Ground* and *Center*.



Range      By Ground, By Center

**Example** If the vertical scale is changed when the Expand function is set to ground, the signal will expand from the ground level\*. The ground level does not change when the vertical scale is changed.

If the vertical scale is changed when the Expand function is set to center, the signal will expand from the center of the signal. The ground level will suit to match the signal position.

\*Or from the upper or lower edge of the screen if the ground level is off screen.

Expand by Ground

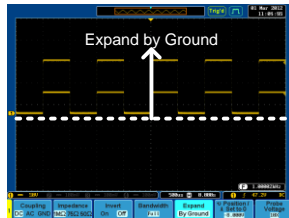

Expand by Center

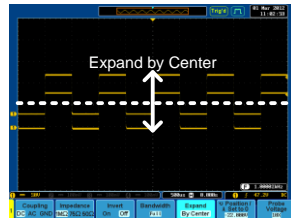

## Select Probe Type

**Background** A signal probe can be set to voltage or current.

**Panel Operation** 1. Press the *Channel* key.



2. Press *Probe* from the bottom menu.

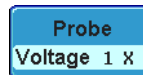

3. Press the *Voltage/Current* softkey to toggle between voltage and current.

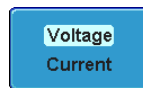

## Select Probe Attenuation Level

**Background**      A signal probe has an attenuation switch to lower the original DUT signal level to the oscilloscope input range, if necessary. The probe attenuation selection adjusts the vertical scale so that the voltage level on the display reflects the real value on a DUT.

**Panel Operation**    1. Press the *Channel* key.



2. Press *Probe* from the bottom menu.



3. Press *Attenuation* on the side menu and use the variable knob to set the attenuation.

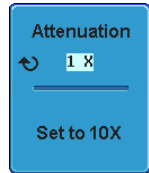

Alternatively, press *Set to 10X*.

**Range**      1mX ~1kX (1-2-5 step)

**Note**              The attenuation factor adds no influence on the real signal. It just changes the voltage/current scale on the display.

## Set the Deskew

---

**Background**      The deskew function is used to compensate for the propagation delay between the oscilloscope and the probe.

---

**Panel Operation**    1. Press one of the *Channel* keys.



2. Press *Probe* from the bottom menu.



3. Press *Deskew* on the side menu and use the variable knob to set the deskew time.

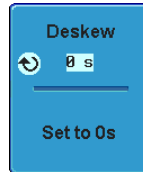

Alternatively, press *Set to 0s* to reset the deskew time.

**Range**      -50ns~50ns, 10ps increments

4. Repeat the procedure for another channel if necessary.

# Trigger

The trigger configures the conditions for when the GDS-3000 captures a waveform.

## Trigger Type Overview

**Edge** The edge trigger is the simplest trigger type. An edge trigger triggers when the signal crosses an amplitude threshold with either a positive or negative slope.

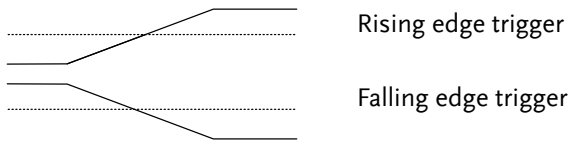

**Delay** The Delay trigger works in tandem with the edge trigger, by waiting for a specified time or number of events before the edge trigger starts. This method allows pinpointing a location in a long series of trigger events.

Note: when using the delay trigger, the edge trigger source can be any one of the channel inputs, the EXT input or the AC line.

Delay trigger example (by event)

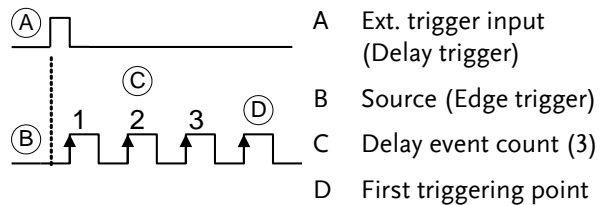

Delay trigger example (by time)

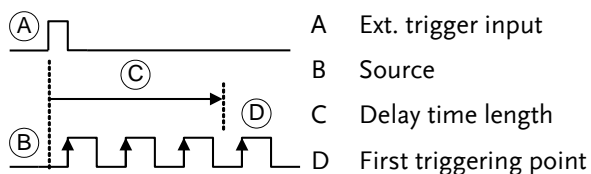

**Pulse Width**      Triggers when the pulse width of the signal is less than, equal, not equal or greater than a specified pulse width.

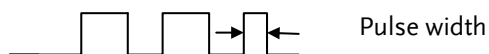

**Video**              Extracts a sync pulse from a video format signal, and triggers on a specific line or field.

**Pulse and Runt**      Triggers on a "runt". A runt is a pulse that passes a specified threshold but fails to pass a second threshold. Both positive and negative runts can be detected.

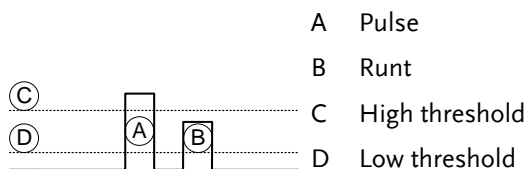

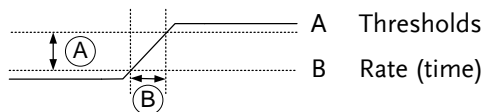

**Rise and Fall**      Trigger on rising and or falling edges, below or over a specified rate. The threshold can also be specified.







## Trigger Parameter Overview

All the following parameters are common for all the trigger types unless stated otherwise.



Trigger Source	CH1 ~ 4	Channel 1 ~ 4 input signals	
	EXT	External trigger input signal	
	AC Line	AC mains signal	
	Alternate	Alternate between channel sources for the trigger source.	
	EXT Probe	Probe trigger source. Set the probe as either current or voltage.	
Trigger Mode	Auto (un-triggered roll)	The GDS-3000 generates an internal trigger if there is no trigger event, to make sure waveforms are constantly updated regardless of trigger events. Select this mode especially when viewing rolling waveforms at slower timebases.	
	Normal	The GDS-3000 acquires a waveform only when a trigger event occurs.	
	Single	The GDS-3000 acquires a waveform once when a trigger event occurs, then stops acquiring. Press the Single key to acquire a waveform again.	

Coupling (Edge, Delay)	DC	DC coupling.
	AC	AC coupling. Blocks DC components from the trigger circuits.
	HF reject	High frequency filter above 50kHz
	LF reject	Low frequency filter below 50kHz
	Reject noise	DC coupling with low sensitivity to reject noise.

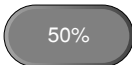
Slope (Edge, Delay, Rise & Fall)		Trigger on a rising edge.
		Trigger on a falling edge.
		Don't care. (Rise & Fall trigger type only)

Trigger Level (Edge, Delay)	Level	Adjusts the trigger manually using the Trigger LEVEL knob.	
	Set to TTL 1.4V	Sets the trigger level to 1.4V, suitable for triggering on TTL signals.	
	Set to ECL - 1.3V	Sets the trigger to -1.3V. This is suitable for ECL circuits.	
	Set to 50%	Sets the trigger level to 50% of the waveform amplitude.	

Holdoff	Holdoff	Sets the holdoff time.
	Set to Minimum	Set the holdoff time to the minimum.

Delay (Delay)	Time	Sets the delay time (10ns ~ 10s) between the trigger event and the real trigger timing.		
	Event	Sets the number of events (1 ~ 65535) passed after the trigger event, until the real trigger timing.		
	Set to Minimum	Sets the source trigger to the minimum time.		
When (Pulse Width)	Sets the pulse width (4ns ~ 10s) and the triggering condition.			
	>	Longer than	=	Equal to
	<	Shorter than	≠	Not equal to
Threshold (Pulse Width)	Sets the amplitude threshold level for the pulse widths.			
	Threshold	-XXV ~ +XXV, user-set level		
	Set to TTL	1.4V		
	Set to ECL	-1.3V		
	Set to 50%	Sets the threshold to 50%		
Standard (Video)	NTSC	National Television System Committee		
	PAL	Phase Alternate by Line		
	SECAM	SEquential Couleur A Memoire		
	EDTV	480P (NTSC) (576p PAL)		
	HDTV	720P, 1080i, 1080P signals		
Polarity (Edge, Video)		Positive polarity (triggered on the high to low transition)		
		Negative polarity (triggered on the low to high transition)		

Trigger On (Video)      Selects the trigger point in the video signal.

Field      1 or 2 or all.

Line      1~263 for NTSC, 1~313 for PAL/SECAM, 1~ 525/625 for EDTV, 1~562/750/1125 for HDTV or all.

---

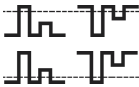
Threshold (Pulse Runt)       Sets the upper threshold limit.

 Sets the lower threshold limit.

Set to TTL      1.4V

Set to ECL      -1.3V

---

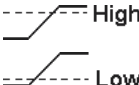
Threshold (Rise & Fall)       **High** Sets the High threshold.

 **Low** Sets the Low threshold.

Set to TTL      1.4V

Set to ECL      -1.3V

## Setup Holdoff Level

**Background** The holdoff function defines the waiting period before the GDS-3000 starts triggering again after a trigger point. The holdoff function ensures a stable display if there are a number of points in a periodic waveform that can be triggered. Holdoff applies to all the triggering types.

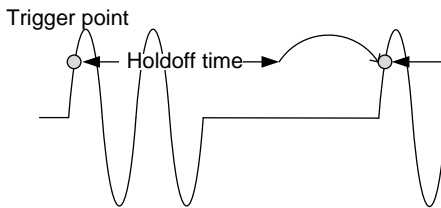

**Panel Operation** 1. Press the trigger *Menu* key.



2. To set the Holdoff time, press the *Holdoff* (or *Mode/Holdoff*) menu button on the bottom bezel.



3. Use the side menu to set the Holdoff time.



Range 10ns~10s

Pressing *Set to Minimum* sets the Holdoff time to the minimum, 10ns.





Note: The holdoff function is automatically disabled when the waveform update mode is in roll mode (page114).

## Setup Trigger Mode

---





**Background** The trigger mode can be set to Normal or Auto (untriggered roll). The triggering mode applies to all the trigger types. See page 114.

---

- Panel Operation**
1. Press the Trigger menu key. 
  2. Press *Mode* from the bottom menu to change the triggering mode. 
  3. Use the side panel to select *Auto* or *Normal* triggering modes.  
Range     Auto, Normal

## Using the Edge Trigger

---

- Panel Operation**
1. Press the Trigger menu key. 
  2. Press *Type* from the lower bezel menu. 
  3. Select *Edge* from the side menu. The edge trigger indicator appears at the bottom of the display.   
  
From left: trigger source, slope, trigger level, coupling
  4. Press *Source* to change the trigger source. 

- Use the side menu to select the trigger source type.

Range Channel 1 ~ 4 (Alternate On/Off),  
Line, EXT (Ext Probe: Volt/Current,  
Attenuation: 1mX~1kX ), AC Line

- Press *Coupling* from the bottom bezel menu to select the trigger coupling or frequency filter settings.



- Choose the coupling from the side menu.

Range DC, AC

- Press *Reject* to toggle the rejection filter from the side menu.

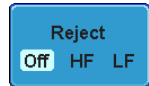

Range HF Reject, LF Reject, Off

- Toggle *Noise Rejection* On or Off from the side menu.

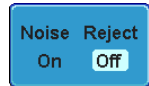

Range On, Off

- From the bottom menu press *Slope* to toggle the slope type.



Range Rising edge, falling edge

- To set the external trigger level, select *Level* from the bottom bezel menu.



12. Set the external trigger level using the side menu.

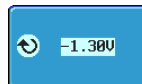

Range 00.0V~ 5 screen divisions

Set to TTL 1.4V

Set to ECL -1.3V

Set to 50%

## Using Advanced Delay Trigger

**Background** The EXT trigger source is always used as the delay triggering source.

- Panel Operation** 1. Press the trigger *Menu* key.

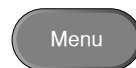

2. Press *Type* from the lower bezel menu.



3. Select *Delay* from the side menu. The delay + edge trigger indicator appears at the bottom of the display.



From left: external source, slope, trigger level, delay + external source

4. To set the delay press *Delay* from the bottom bezel.

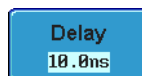

5. To Delay by Time, press *Time* from the side menu and set the delay time.

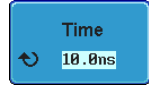

Range 10ns ~ 10s (by time)  
Set to minimum

6. To Delay by Event, press *Event* from the side menu and set the number of events.



Range 1 ~ 65535 events  
Set to Minimum

## Using Pulse Width Trigger

- Panel Operation 1. Press the trigger *Menu* key.



2. Press the *Type* key from the lower bezel menu.



3. Select *Pulse Width* from the side menu. The pulse width trigger indicator appears at the bottom of the display.

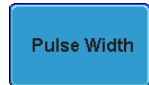

From left: external source, polarity, when

4. Press *Source* from the lower bezel.



- Use the side menu to select the pulse width trigger source.

Range Channel 1 ~ 4 (Alternate On/Off),  
Line, EXT (Ext Probe: Volt/Current,  
Attenuation: 1mX~1kX), AC Line

- Press *Polarity* to toggle the polarity type.



Range Positive (high to low transition)  
Negative (low to high transition)

- Press *When* from the lower bezel.

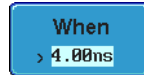

- Then use the side menu to select the pulse width condition and width.

Condition >, <, =, ≠

Width 4ns ~ 10s

- Press *Threshold* from the lower bezel to edit the pulse width threshold.

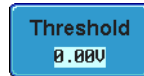

- Use the side menu to set the threshold.

Range -XXV~XXV  
Set to TTL 1.4V  
Set to ECL -1.3V  
Set to 50%

## Using Video Trigger

Panel Operation

1. Press the trigger *Menu* key.



2. Press the *Type* key from the lower bezel menu.



3. Select *Video* from the side menu.  
The video trigger indicator appears at the bottom of the display.



From left: channel, video standard, field, line

4. Press *Source* from the lower bezel.



5. Use the side menu to select the video trigger source.

Range Channel 1 ~ 4

6. Press *Standard* on the bottom bezel.



7. Use the side menu to select the video standard.

Range NTSC, PAL, SECAM, EDTV (480P/576P), HDTV (720P/1080i/1080P)

8. Press *Trigger On* to edit the video field and line.



- Use the side menu to select the field and line.

Field 1, 2, All

Video line NTSC: 1 ~ 262 (Even), 1 ~ 263 (Odd)  
PAL/SECAM: 1 ~ 312 (Even),  
1 ~ 313 (Odd),

EDTV(480P): 1~ 525, EDTV(576P):  
1~ 625

HDTV(720P): 1~ 750, HDTV (1080i):  
1 ~ 562 (even), 1~563 (odd), HDTV  
(1080P): 1~1125, All

- Press *Polarity* to toggle the polarity type.



Range positive, negative

## Pulse Runt trigger

- Panel Operation
- Press the trigger *Menu* key.



- Press the *Type* key from the lower bezel menu.



- Select *Others* → *Pulse Runt* from the side menu. The Pulse and Runt indicator appears at the bottom of the display.

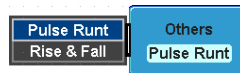

From left: Polarity, source, high/low threshold, threshold level

4. Press *Source* from the lower menu.



5. Use the side menu to select a source.

Range Channel 1 ~ 4

6. Press *Polarity* to toggle the polarity.

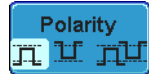

Range Rising edge, falling edge, either.

7. Press *When* from the lower menu.

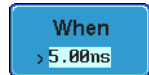

8. Then use the side menu to select the condition and width.

Condition > , < , = , ≠

Width 4ns ~ 10s

9. Press *Threshold* from the lower bezel to edit the threshold for each input source.

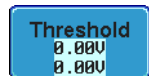

10. Use the side menu to set the upper threshold.

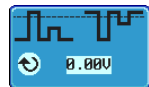

Range -XXV~XXV

Set to TTL 1.4V

Set to ECL -1.3V

- Use the side menu to set the lower threshold.



Range      -XXV~XXV  
             Set to TTL 1.4V  
             Set to ECL -1.3V

## Using Rise and Fall Trigger

- Panel Operation   1. Press the trigger *Menu* key.



- Press the *Type* key from the lower bezel menu.



- Select *Others* → *Rise and Fall* from the side menu. The Rise and Fall indicator appears at the bottom of the display.



From left: rise and fall, source, high/low threshold, threshold level

- Press *Source* from the lower menu.



- Use the side menu to select a source.

Range      Channel 1 ~ 4

6. Press *Slope* from the bottom menu to toggle the slope.



Range Rising edge, falling edge, either

7. Press *When* from the lower menu.



8. Then use the side menu to select the logic conditions and true or false status.

Condition > , < , = , ≠

Width 4ns ~ 10s

9. Press *Threshold* from the lower bezel to edit the threshold for each input source.



10. Use the side menu to set the threshold for the current input.

Range High: -XXV~XV

Low: -XXV~XXV

Set to TTL 1.4V

Set to ECT -1.3V

## System Info / Language / Clock

This section describes how to set the interface, beeper, language, time/date, and probe compensation signal.

### Select Menu Language

---

Parameter	The following is a list of language available by default. Language selection may differ according to the region to which the GDS-3000 is shipped.	
	<ul style="list-style-type: none"> <li>• English</li> <li>• Chinese (simplified)</li> <li>• Japanese</li> <li>• French</li> <li>• German</li> </ul>	<ul style="list-style-type: none"> <li>• Chinese (traditional)</li> <li>• Korean</li> <li>• Polish</li> <li>• Russian</li> </ul>

---

Panel Operation 1. Press the *Utility* key.



2. Select the language from the side menu.

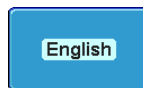

Range\* English, Trad. Chinese, Simp. Chinese, Korean, Japanese, Polish, French, Russian, German.

\*Language selection may differ based on region.

### View System Information

---

Panel Operation 1. Press the *Utility* key.



2. Press *System* from the lower menu.



3. Press *System Info* from the side menu. A display panel will appear showing:



- Manufacturer name
- Model name
- Serial number
- Firmware version
- Manufacturer URL
- App download location



## Erase Memory

**Background** The Erase Memory function will erase all internal waveforms, setup files and labels from internal memory.

**Erased Items** Waveform 1~20, Setting memory 1~20, Reference 1~4, Labels

**Panel Operation** 1. Press the *Utility* key.



2. Press *System* from the lower menu.

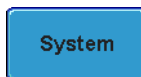

3. Press *Erase Memory* from the side menu.

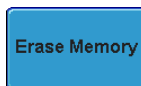

A message will prompt you to press Erase Memory again to confirm the process.

4. Press *Erase Memory*.

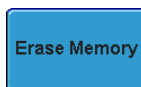

## Set the Buzzer Volume

- Panel Operation
1. Press the *Utility* key.



2. Press *System* from the lower menu.

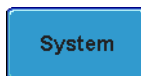

3. Press the buzzer icon on the side panel. Use the variable knob to set the volume.



## Set Date and Time

- Panel Operation/  
Parameter
1. Press the *Utility* key.



2. Press *Date & Time* on the lower menu.



3. Set the *Year*, *Month*, *Day*, *Hour* and *Minute* from the side menu.

Year 2000 ~ 2037



Month 1 ~ 12



Day 1 ~ 31

Hour 1~23

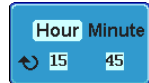

Minute 0~59

4. Press *Save Now* from the side menu to save the date and time.



5. Make sure the date/time setting is correctly reflected at the top of the display.



# SAVE/RECALL

<b>File Format/Utility.....</b>	<b>147</b>
Image File Format.....	147
Waveform File Format.....	147
Spreadsheet File Format .....	148
Setup File Format.....	149
<b>Create/Edit file labels .....</b>	<b>151</b>
<b>Save .....</b>	<b>153</b>
File Type/Source/Destination.....	153
Save Image .....	154
Save Image - Print/Save Key .....	155
Save Waveform .....	157
Save Setup .....	158
<b>Recall.....</b>	<b>160</b>
File Type/Source/Destination.....	160
Recall Default Panel Settings.....	160
Recall Waveform .....	162
Recall Setup.....	163
<b>Reference Waveforms .....</b>	<b>165</b>
Recall and Display Reference Waveforms .....	165

## File Format/Utility

### Image File Format

---

Format	DSxxxx.bmp or DSxxxx.png
Contents	The current display image is 800 by 600 pixels. The background color can be inverted (Ink saver function). Each image file is numbered consecutively from DS0001 to DS9999.

### Waveform File Format

---

Format	DSxxx.lsf, CH1~CH4.lsf	
	The LSF file format efficiently stores waveforms. This is the file format that is used for storing and recalling waveforms for measurement with the GDS-3000 series oscilloscopes.	
Waveform Type	CH1 ~ 4	Input channel signal
	Math	Math operation result (page 82)
Storage Location	Wave1 ~ Wave20	Waveform files stored to the internal memory. Stored waveforms can be copied to Ref. 1 ~ 4 to be viewed on the display. (W1 ~ W20 waveforms cannot be directly recalled on the display).

Ref 1~4      Reference waveforms stored in the internal memory, separate from W1 ~ W20. Reference waveforms (Ref 1 ~ 4) can be displayed directly onto the display with amplitude and frequency information. Ref 1~4 are useful for reference purposes. Other waveforms (LSF and W1~20) must be recalled to R1~4 before being displayed.

Contents:      The waveform data can be used for detailed  
Waveform Data      analysis. It consists of the horizontal and vertical data used by the waveform for the entire memory length.

### Spreadsheet File Format

Format      DSxxxx.csv (Comma-separated values format, can be opened in spreadsheet applications such as Microsoft Excel). CSV files cannot be recalled onto the GDS-3000 series of oscilloscopes.

Waveform Type      CH1 ~ 4      Input channel signal  
Math      Math operation result (page82)

Contents:      Digital waveform data containing the channel  
Waveform Data      information such as vertical and horizontal position of a signal for the entire memory length.

Contents: Other      The following information is also included in the  
Data      waveform file.

- Firmware version
- Horizontal mode
- Trigger level
- Vertical scale
- Vertical position
- Time of acquisition
- Memory length
- Vertical units
- Probe level
- Horizontal units

- Horizontal scale
- Horizontal position
- Time (of points)
- Horizontal scale
- Sampling period
- Channel

## Setup File Format

Format DSxxxx.set (proprietary format)  
 The setup file saves or recalls the following settings.

Contents	Acquire	<ul style="list-style-type: none"> <li>• Mode</li> <li>• Sample rate</li> </ul>	<ul style="list-style-type: none"> <li>• XY</li> <li>• Sample mode</li> </ul>
	Display	<ul style="list-style-type: none"> <li>• Mode</li> <li>• Persistence</li> <li>• Waveform intensity</li> </ul>	<ul style="list-style-type: none"> <li>• Graticule intensity</li> <li>• Waveform visuals</li> <li>• Graticule</li> </ul>
	Channel	<ul style="list-style-type: none"> <li>• Scale</li> <li>• Channel</li> <li>• Coupling</li> <li>• Impedance</li> <li>• Invert</li> <li>• Bandwidth</li> </ul>	<ul style="list-style-type: none"> <li>• Expand</li> <li>• Position</li> <li>• Probe</li> <li>• Probe attenuation</li> <li>• Deskew</li> </ul>
	Cursor	<ul style="list-style-type: none"> <li>• Horizontal cursor</li> </ul>	<ul style="list-style-type: none"> <li>• Vertical cursor</li> </ul>
	Measure	<ul style="list-style-type: none"> <li>• Source</li> <li>• Gating</li> </ul>	<ul style="list-style-type: none"> <li>• Display</li> </ul>
	Horizontal	<ul style="list-style-type: none"> <li>• Scale</li> </ul>	
	Math	<ul style="list-style-type: none"> <li>• Source1</li> <li>• Operator</li> <li>• Source2</li> </ul>	<ul style="list-style-type: none"> <li>• Position</li> <li>• Unit/Div</li> <li>• Math Off</li> </ul>



Trigger	<ul style="list-style-type: none"><li>• Type</li><li>• Source</li><li>• Coupling</li><li>• Alternate</li><li>• Rejection</li></ul>	<ul style="list-style-type: none"><li>• Noise Rejection</li><li>• Slope</li><li>• Level</li><li>• Mode</li><li>• Holdoff</li></ul>
Utility	<ul style="list-style-type: none"><li>• Language</li><li>• Print key</li></ul>	<ul style="list-style-type: none"><li>• Ink Saver</li></ul>
Save/ recall	<ul style="list-style-type: none"><li>• Image file format</li></ul>	<ul style="list-style-type: none"><li>• Data file format</li></ul>

## Create/Edit file labels

---

**Format** Reference files and Setup files stored in internal memory can have individual labels set. The labels are used on the reference waveform and setup file icons.

---

- Panel Operation**
1. Press the *Save/Recall* key from the front panel. 
  2. Press *Edit File Label* from the bottom menu. 
  3. Press *Label For* to choose a Reference or Setup file. 

Label For Ref1~4, Set1~20
  4. To choose a preset label, Press *User Preset* from the side menu and choose a label. 

Labels ACK, AD0, ANALOG, BIT, CAS, CLK, CLOCK, CLR, COUNT, DATA, DTACK, ENABLE, HALT, INT, IN, IRQ, LATCH, LOAD, NMI
- 

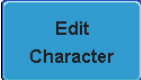
- Edit Label**
1. Press *Edit Character* to edit the current label. 

- The Edit Label window appears.



- Use the Variable knob to highlight a character.

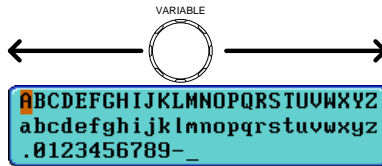

Press *Enter Character* to select a number or letter.

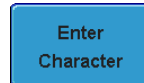

Press *Back Space* to delete a character.



Press *Editing Completed* to create the new label and return to the previous menu.

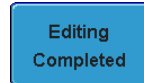

Cancel

Press *Cancel* to cancel the operation and return to the previous menu.



## Save

### File Type/Source/Destination

Item	Source	Destination
Panel Setup (DSxxxx.set)	<ul style="list-style-type: none"> <li>• Front panel settings</li> </ul>	<ul style="list-style-type: none"> <li>• Internal memory: Set1 ~ Set20</li> <li>• File system: Disk, USB</li> </ul>
Waveform Data (DSxxxx.csv) (DSxxxx.lsf) (CH1~CH4.lsf, Ref1~Ref4.lsf, Math.lsf)* ALLxxxx.csv	<ul style="list-style-type: none"> <li>• Channel 1 ~ 4</li> <li>• Math operation result</li> <li>• Reference waveform Ref1~4</li> <li>• All displayed waveforms</li> </ul>	<ul style="list-style-type: none"> <li>• Internal memory: Reference waveform Ref1~4, Wave1 ~ Wave20</li> <li>• File system: Disk, USB</li> </ul>
Display Image (DSxxxx.bmp) (DSxxxx.png)	<ul style="list-style-type: none"> <li>• Display image</li> </ul>	<ul style="list-style-type: none"> <li>• File system: Disk, USB</li> </ul>

\*Stored in ALLXXX directories when All Displayed waveforms are saved

## Save Image

- Panel Operation
- To save to USB, connect a USB drive to the front or rear panel USB port. If a USB drive is not connected, images will be saved to the internal memory.  
Note: Only one host connection, front or rear, is allowed at a time.

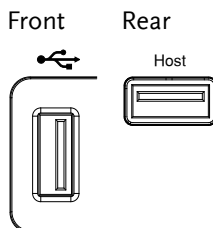

- Press the *Save/Recall* key from the front panel.

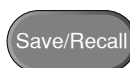

- Press *Save Image* from the bottom menu.



- Press *File Format* to choose PNG or BMP file types.



Range DSxxxx.bmp, DSxxxx.png

- Press *Ink Saver* to toggle Ink Saver On or Off.

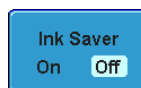

Ink Saver On

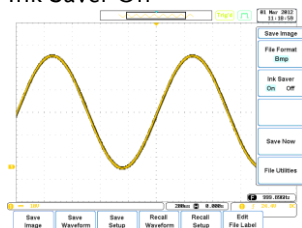

Ink Saver Off



- Press *Save Now* from the side menu to save the display as an image file.



Note 

The file will not be saved if the power is turned Off or the USB drive is taken out before the message ends.

USB File Utility To edit the USB flash drive contents (create/ delete/ rename files and folders) or to edit the default file path, press *File Utilities* from the side menu. See page 166 for details.

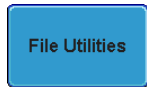

### Save Image - Print/Save Key

Background The Print/Save key can be assigned to Print or to Save. When assigned to Save, pressing the Print/Save key will save a screen image to USB.

- Panel Operation
- Connect a USB drive to the front or rear panel USB port. Note: Only one host connection, front or rear, is allowed at a time.

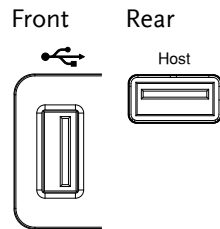

- Press the *Utility* key.



- Press *Printout* from the bottom menu.



- On the side menu, press *Function* repeatedly to select *Save*.



The *Save* led on the screen bezel will be lit when the printout function is set to *Save*.



- Press the *Print/Save* key to save to USB.



### Ink Saver

To invert the color for the saved or printed display image, press *Ink Saver* repeatedly to toggle *Ink Saver On* or *Off* from the side menu.

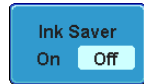

Ink Saver On (Inverted)

Ink Saver Off (Normal)

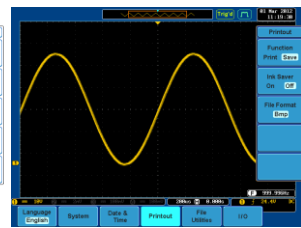
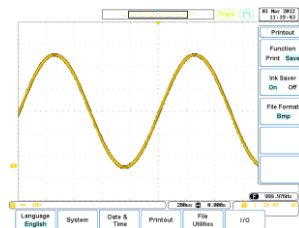

## Save Waveform

- Panel Operation
- (For saving to an external USB flash drive) Connect the drive to the front or rear panel USB port.  
 Note: Only one host connection, front or rear, is allowed at a time.

Front

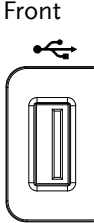



Rear

Host



  - Press the *Save/Recall* key from the front panel.

  - Press *Save Waveform* from the bottom menu.

  - Choose the *From* waveform on the side menu.



Source	CH1~4, Math, Ref1~4, All Displayed
--------	------------------------------------
  - Press *To* (internal memory) or *To File* and choose a destination to save.



To	Ref1~4, Wave1~4
To File	DSxxxx.csv, DSxxxx.lsf, CH1~CH4.lsf*

\*(saved to an ALLxxx directory)
  - Press *Save Now* to confirm saving. When completed, a message appears at the bottom of the display.



Waveform save to Disk: \DS0001.CSV completed!

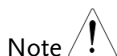

The file will not be saved if the power is turned Off or the USB drive is taken out before the message ends.

#### USB File Utility

To edit USB flash drive contents (create/ delete/ rename files and folders), press *File Utilities*. For details, see page 166.

File Utilities

#### PC Software (FreeWave)

Saving waveforms can also be accomplished using FreeWave, downloadable from GWInstek website.



## Save Setup

#### Panel Operation

- (For saving to an external USB flash drive) Connect the drive to the front or rear panel USB port.  
Note: Only one host connection, front or rear, is allowed at a time.

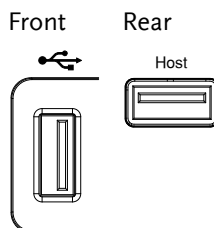

- Press the *Save/Recall* key from the front panel.
- Press *Save Setup* from the bottom menu.

Save/Recall

Save  
Setup

4. Press *To* (internal memory) or *To File* and choose a destination to save.

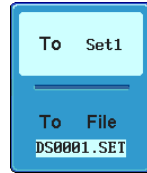

To           Set1~Set20  
To File      DSxxxx.set

5. Press *Save Now* to confirm saving. When completed, a message appears at the bottom of the display.



Note  The file will not be saved if the power is turned Off or the USB drive is taken out before the message ends.

USB File Utility      To edit USB flash drive contents (create/ delete/ rename files and folders) or to set the file path, press *File Utilities*. For details, see 166.

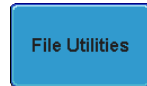

Edit Label            To edit labels for Setup files, press *Edit Label*. For more details on editing labels, see page 151.

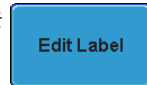

# Recall

## File Type/Source/Destination

Item	Source	Destination
Default Panel Setup	<ul style="list-style-type: none"> <li>Factory installed setting</li> </ul>	<ul style="list-style-type: none"> <li>Current front panel setting</li> </ul>
Reference Waveform	<ul style="list-style-type: none"> <li>Internal memory: Ref1~4</li> </ul>	<ul style="list-style-type: none"> <li>Current front panel</li> </ul>
Panel Setup (DSxxxx.set)	<ul style="list-style-type: none"> <li>Internal memory: S1 ~ S20</li> <li>File system: Disk, USB</li> </ul>	<ul style="list-style-type: none"> <li>Current front panel</li> </ul>
Waveform Data (DSxxxx.lsf) (CH1~CH4.lsf, Ref1~Ref4.lsf, Math.lsf)*	<ul style="list-style-type: none"> <li>Internal memory: Wave 1 ~ Wave20</li> <li>File system: Disk, USB</li> </ul>	<ul style="list-style-type: none"> <li>Reference waveform 1 ~ 4</li> </ul>

\*Recalled from ALLXXX directories.

## Recall Default Panel Settings

Panel Operation 1. Press the *Default Setup* key.



2. The screen will update with the default panel settings.

Setting Contents The following is the default (factory) setting contents.

Acquire	Mode: Sample Sample mode: Sinc	XY: OFF Sample rate: 250MSPS (200MSPS GDS350X)
Display	Mode: Vector Waveform intensity: 50% Waveform visuals: Gray	Persistence: Auto Graticule intensity: 50% Graticule: full 
Channel	Scale: 100mV/Div Coupling: DC Invert: Off Expand: By ground Probe: voltage Deskew: 0s	CH1: On Impedance: 1MΩ Bandwidth: full Position: 0.00V Probe attenuation: 1x
Cursor	Horizontal cursor: Off	Vertical Cursor: Off
Measure	Source1: CH1 Gating: Off	Source2: CH2 Display: Off
Horizontal	Scale: 10us/Div	
Math	Source1: CH1 Source2: CH2 Unit/Div: 200mV	Operator: + Position: 0.00 Div Math Off
Test	App: Go-NoGo	
Trigger	Type: Edge Coupling: DC Rejection: Off Slope: positive Mode: Auto	Source: CH1 Alternate: Off Noise Rejection: Off Level: 0.00V Holdoff: 10.0ns

Utility

Language: English

Print key: Save

Ink Saver: Off

Save Recall

Image file format: Bmp

Data file format: LSF

## Recall Waveform

Panel Operation

1. (For recalling from an external USB flash drive) Connect the drive to the front or rear panel USB port. Note: Only one host connection, front or rear, is allowed at a time.

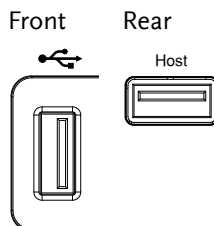

2. The waveform must be stored in advance. See page 155 for waveform store details.
3. Press the *Save/Recall* key.



4. Press *Recall Waveform* from the bottom menu. The Recall menu appears.

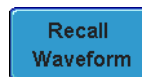

5. Press *From* (internal memory) or *From File* and choose a source to recall from.



From Wave1~20

From File\* DSxxxx.lsf, CH1~CH4.lsf

\*Only files in the current file path will be available, this includes files saved in the ALLXXX directories.

6. Press *To* and select the reference waveform to recall to.

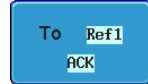

To Ref1~4

7. Press *Recall Now* to recall the waveform.

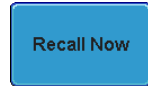

USB File Utility

To edit USB flash drive contents (create/ delete/ rename files and folders) or to set the file path, press *File Utilities*. For details, see page 166.

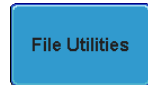

Recall Setup

Panel Operation

1. (For recalling from an external USB flash drive) Connect the drive to the front or rear panel USB port. Note: Only one host connection, front or rear, is allowed at a time.

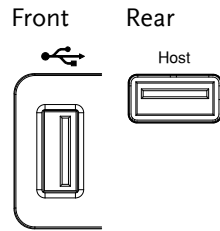

2. Press the *Save/Recall* key.



3. Press *Recall Setup* from the bottom menu.

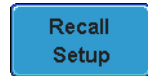

4. Press *From* (internal memory) or *From File* and choose a source to recall from.

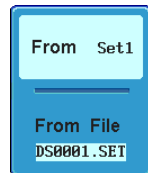



From Set1~20

From File DSxxxx.set (USB, Disk)\*

\* Only files in the current file path will be available.

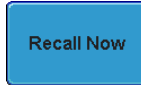
5. Press *Recall Now* to confirm recalling. When completed, a message appears at the bottom of the display.



Note 

The file will not be recalled if the power is turned Off or the USB drive is taken out before the message ends.

---

USB File Utility

To edit USB flash drive contents (create/ delete/ rename files and folders) or to set the file path, press *File Utilities*. For details, see page 166.



Edit Label

To edit labels for Setup files, press *Edit label*. For more details on editing labels, see page 151.



# Reference Waveforms

## Recall and Display Reference Waveforms

**Panel Operation** A reference waveform must be stored in advance. See page 155 to store waveforms as reference waveforms.

1. Press the *REF* key on the front panel.



2. Pressing *R1~R4* repeatedly will toggle the corresponding reference waveform OFF/ON.

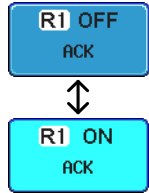

Turning *R1~R4* ON will open the corresponding reference menu.

3. If a reference waveform is ON but not active, its reference menu can be opened by pressing the corresponding *R1~R4* key from the bottom menu.

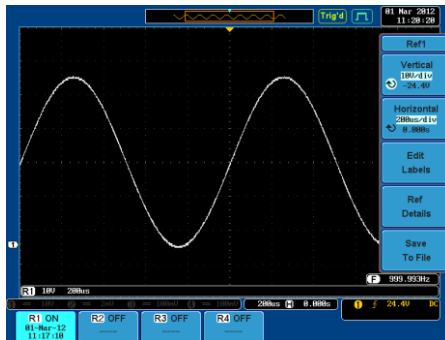
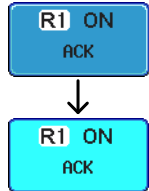

Vertical Navigation

Press *Vertical* repeatedly from the side menu to choose to edit the vertical position or Volts/Div. Use the Variable knob to edit the values.

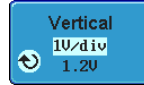

Horizontal Navigation

Press *Horizontal* repeatedly from the side menu to choose to edit the Time/Div or the horizontal position. Use the Variable knob to edit the value.

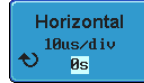

View Reference Waveform Details

Pressing *RefDetails* will display the reference waveform details.



Details Sample Rate, Record Length, Date

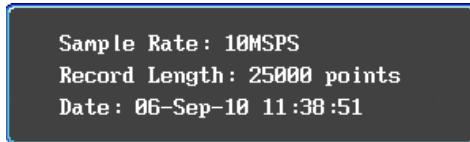

Edit Labels

To edit labels for Setup files, press *Edit labels*. For more details on editing labels, see page 151.



Save Reference Waveforms

To save reference waveforms, press *Save to File*. For more Details on saving waveforms, see page 147.



# F FILE UTILITIES

The file utilities are used each time files need to be saved to internal or external memory. The file utilities can create directories, delete directories and rename files. BMP and PNG image files can be previewed in the file system. The File Utilities menu also sets the file path for saving and recalling files from the Save/Recall menu.

---

File Navigation .....	168
Create Folder .....	169
Rename File .....	170
Delete File .....	172
Copy File to USB .....	173

## File Navigation

The File Utilities menu can be used to choose files or to set the file path for saving/recalling files.

File System

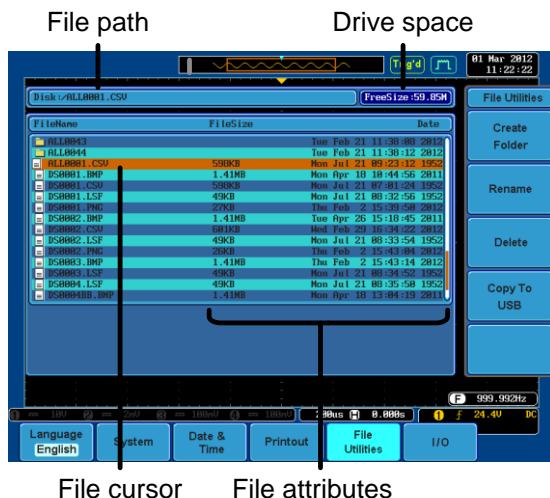

Panel Operation

1. Press the *Utility* key.



2. Press *File Utilities* from the bottom menu.



3. The file system appears.

4. Use the *Variable* knob to move the file cursor up and down.



Use the *Select* key to choose a file or directory or to set the file path.

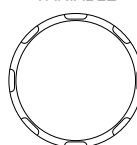

The file path can be set to internal memory or to a directory on a USB memory stick.

Select

**Note** Selecting a waveform file will cause that file to be recalled to the currently configured reference waveform.

## Create Folder

**Panel Operation** 1. Press the *Utility* key.

Utility

2. Press *File Utilities* from the bottom menu.

File Utilities

3. Use the variable knob and select key to navigate the file system.



**Create Folder** 4. Press *Create Folder* to make a new directory at the selected location.

Create Folder

- Use the *Variable* knob to highlight a character.

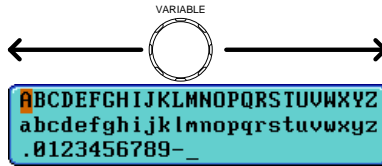

Press *Enter Character* to select a number or letter.

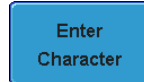

Press *Back Space* to delete a character.



- Press *Editing completed* to create the folder name.

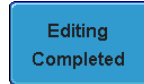

Cancel

Press *Cancel* to cancel the operation.



## Rename File

- Panel Operation
- Press the Utility key.



- Press *File Utilities* from the bottom menu.



- Use the variable knob and select key to choose a file to rename.



4. Press *Rename* when a file is chosen.

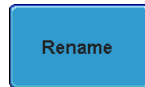

5. Use the *Variable* knob to highlight a character.

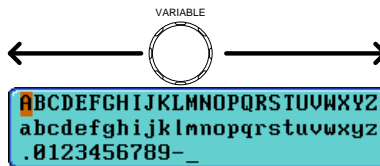

Press *Enter Character* to select a number or letter.

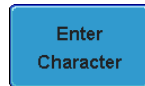

Press *Back Space* to delete a character.



6. Press *Editing completed* to create the folder or file name.

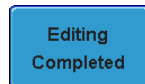

## Delete File

Panel Operation 1. Press the *Utility* key.

 Utility

2. Press *File Utilities* from the bottom menu.

 File  
Utilities

3. Use the variable knob and select key to navigate the file system to choose a file.



4. Press *Delete* to delete the selected file.



 Delete

5. Press *Delete* again to confirm the deletion.

 Delete

## Copy File to USB

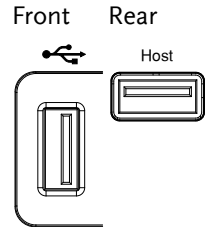
- Panel Operation 1. Connect a USB drive to the front or rear panel USB port.  
 Note: Only one host connection, front or rear, is allowed at a time.



- Panel Operation 2. Press the *Utility* key.



3. Press *File Utilities* from the bottom menu.



4. Use the variable knob and select key to navigate the file system to choose a file from internal memory.



5. Press *Copy to USB* to copy the selected file to the USB drive.



# PRINT OUT

Screen images can be printed to some PictBridge compatible printers using the USB device port. The GDS-3000 has a dedicated Print/Save key for quick and easy printing. To reduce the amount of printer ink used for each print, images can be printed using the Ink Saver function.

Screen images can also be printed using the remote control software, FreeWave, downloadable from the GWInstek website.

## Printer I/O Configuration

---

Panel Operation 1. Connect a PictBridge printer to the USB device port on the rear panel.

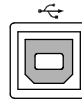

2. Press the *Utility* key.



3. Press *I/O* from the bottom menu.

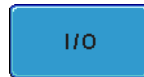





4. Press *USB Device Port* from the side menu and select *Printer*.



## Print Output

Ensure the USB port has been configured to Printer before trying to print, see page 174.

- Panel Operation
1. Press the *Utility* key.
 
  2. Press *Printout* from the bottom menu.
 
  3. On the side menu, press *Function* repeatedly to select Print.
 
  4. The Print led on the screen bezel will be lit when the printout Function is set to *Print*.
 
  5. Press the Print/Save key located on the screen bezel. The display image is printed out.
 

Ink Saver

To have a white background on the saved or printed display image, press *Ink Saver* repeatedly to toggle Ink Saver On or Off from the side menu.



Ink Saver On

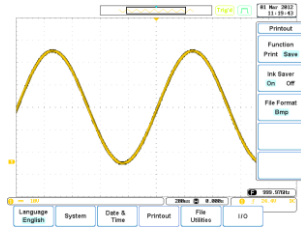

Ink Saver Off

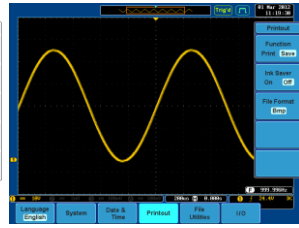

# REMOTE CONTROL CONFIG

This chapter describes basic configuration for remote control. For a command list, refer to the programming manual downloadable from GWInstek website, [www.gwinstek.com](http://www.gwinstek.com)

---

<b>Interface Configuration .....</b>	<b>178</b>
Configure USB Interface.....	178
Configure RS-232C Interface .....	179
Configure the Ethernet Interface.....	180
Configure GPIB Interface .....	183
USB/RS-232C Remote Control Software .....	184
 <b>Web Server .....</b>	 <b>184</b>
Web Server Overview.....	184

## Interface Configuration

### Configure USB Interface

USB Configuration	PC side connector	Type A, host
	GDS-3000 side connector	Type B, slave
	Speed	1.1/2.0 (high speed)
	USB Class	CDC (communications device class)

Panel Operation 1. Press the Utility key.



2. Press I/O from the bottom menu.

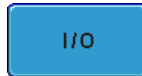

3. Press USB Device Port from the side menu.



4. Press *Computer* from the side menu.



5. Connect the USB cable to the rear panel slave port.



6. When the PC asks for the USB driver, select the USB driver included in the FreeWave software package. The driver file automatically sets the GDS-3000 to a serial COM port. The Freewave software package is downloadable from GDS-3000 product section of the GW Instek website, [www.gwinstek.com](http://www.gwinstek.com).

Configure RS-232C Interface

RS-232C Configuration	Connector	DB-9, Male
	Baud rate	2400, 4800, 9600, 19200, 38400, 57600, 115200
	Parity	None, Odd, Even
	Data bit	8 (fixed)
	Stop bit	1, 2

Panel Operation 1. Press the *Utility* key.



2. Press *I/O* from the bottom menu.

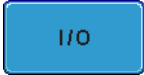

3. Press *RS-232C* from the side menu.



4. Use the side menu to set the Baud Rate.



Baud Rate 2400, 4800, 9600, 19200, 38400, 57600, 115200

5. Press *Stop Bit* to toggle the number of stop bits.



Stop Bits 1, 2

6. Press *Parity* to toggle the parity.



Parity Odd, Even, None

7. Press *Save Now* to save the settings.



8. Connect the RS-232C cable to the rear panel port: DB-9 male connector. For a functionality check, see page 184.

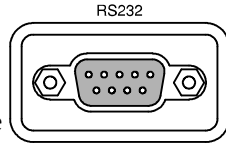

Pin Assignment

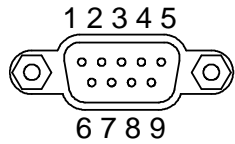

- 2: RxD (Receive data)
- 3: TxD (Transmit data)
- 5: GND
- 4, 6 ~ 9: No connection

PC Connection

Use the Null Modem connection as in the below diagram.

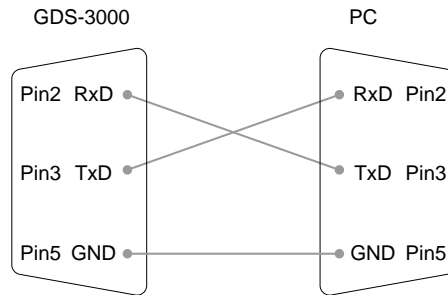

## Configure the Ethernet Interface

Ethernet Configuration

- |                       |                      |
|-----------------------|----------------------|
| MAC Address           | Domain Name          |
| Instrument Name       | DNS IP Address       |
| User Password         | Gateway IP Address   |
| Instrument IP Address | Subnet Mask          |
|                       | HTTP Port 80 (fixed) |

Background The Ethernet interface is used for remote control over a network.

Panel Operation 1. Press the *Utility* key.



2. Press *I/O* from the bottom menu.

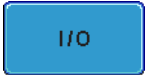

3. Press *Ethernet* from the side menu.



4. Set *DHCP/BOOTP* to *On* or *Off* from the side menu.

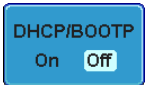

IP addresses will automatically be assigned with DHCP/BOOTP set to on. For Static IP Addresses, DHCP/BOOTP should be set to off.

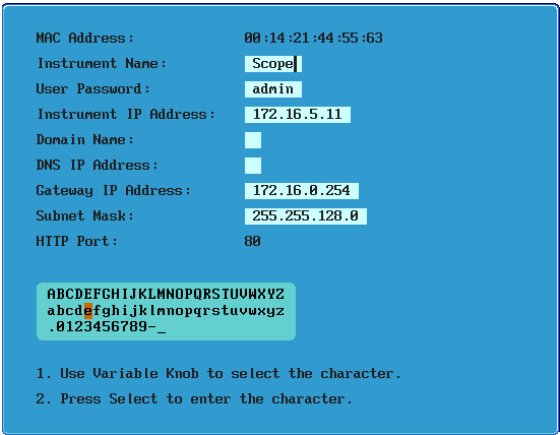

MAC Address : 00:14:21:44:55:63  
Instrument Name : Scope  
User Password : admin  
Instrument IP Address : 172.16.5.11  
Domain Name :  
DNS IP Address :  
Gateway IP Address : 172.16.0.254  
Subnet Mask : 255.255.128.0  
HTTP Port : 80

ABCDEFGHIJKLMNOPQRSTUVWXYZ  
abcdefghijklmnopqrstuvwxyz  
.0123456789- \_

1. Use Variable Knob to select the character.  
2. Press Select to enter the character.

5. Use the *Up* and *Down* arrows on the side menu to navigate each Ethernet configuration item.

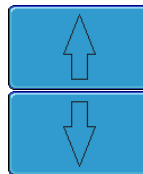

Items      MAC Address, Instrument Name, User Password, Instrument IP Address, Domain Name, DNS IP Address, Gateway IP Address, Subnet Mask

Note: HTTP Port is fixed at 80.

6. Use the Variable knob to highlight a character and use the Select key to choose a character.

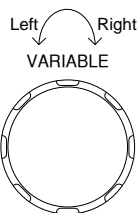

Press *Backspace* to delete a character.



7. Connect the Ethernet cable to the rear panel of the GDS-3000.



## Configure GPIB Interface

To use GPIB, the optional GPIB to USB (GUG-001) adapter must be used. The GPIB address can be configured for the GUG-001 from the utility menu. See the GUG-001 user manual for more information.

### Configure GPIB

1. Insert the GUG-001 USB cable into the rear panel USB device port.



2. Press the *Utility* key.



3. Press *I/O* from the bottom menu.



4. Press USB Device Port from the side menu.



5. Press *GPIB* from the side menu.



6. Use the variable knob to set the GPIB Address from the side menu.

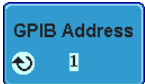

Range 1 ~ 30

- GPIB Constraints
- Maximum 15 devices altogether, 20m cable length, 2m between each device
  - Unique address assigned to each device
  - At least 2/3 of the devices turned On
  - No loop or parallel connection

## USB/RS-232C Remote Control Software

---

Terminal Application (USB/RS-232C)	<p>Invoke the terminal application such as telnet. For RS-232C, set the COM port, baud rate, stop bit, data bit, and parity accordingly.</p> <p>To check the COM port No, see the Device Manager in the PC. For WinXP, Control panel → System → Hardware tab.</p>
Functionality Check	<p>Key in this query command via the terminal.</p> <pre>*!dn?</pre> <p>This should return the Manufacturer, Model number, Serial number, and Firmware version in the following format.</p> <pre>GW, GDS-3152, EK0000001, V1.00</pre> <p>Note: remember to use the appropriate terminal character when entering the command.</p>
PC Software (USB only)	<p>The proprietary PC software FreeWave is downloadable from the GWInstek website for remote control.</p>

## Web Server

### Web Server Overview

---

Background	<p>The GDS-3000 has an inbuilt web server that can be used to:</p> <ul style="list-style-type: none"> <li>• view the system information (Welcome Page)</li> <li>• set/view the network configuration settings (Network Configuration)</li> <li>• remotely view the current display image on the unit (Get Display Image)</li> </ul>
------------	---

System Information:

- Manufacturer
- Serial Number
- Firmware version
- Hostname
- Domain name
- IP Address
- Subset Mask
- DNS
- MAC Adress
- DHCP State



[Visit Our Site](#)

[Support](#) | [Contact Us](#)

Welcome Page

GDS-3000 Series Web Control Pages

System Information

Network Configuration

Thanks For Your Using

Use the left menu to select the features you need.

Get Display Image

More How-to Please refer to user manual

Manufacturer:	GW
Serial Number:	P930116
Description:	GW,GDS-3354
Firmware Version:	V1.08
Hostname:	G-30116
Domain Name:	
IP Address:	172.16.20.66
Subnet Mask:	255.255.128.0
Gateway:	172.16.0.254
DNS:	172.16.1.248
MAC Address:	02:50:ad:25:21:21
DHCP State:	ON



Copyright 2010 © Good Will Instrument Co., Ltd All Rights Reserved.

Network Configuration

- Hostname
- Domain name
- IP Address
- Subnet mask
- Gateway
- DNS
- DHCP State



[Visit Our Site](#)

[Support](#) | [Contact Us](#)

Welcome Page

Network Configuration

Network Configuration

Get Display Image

Hostname:	<input type="text" value="G-30116"/>
Domain Name:	<input type="text"/>
IP Address:	<input type="text" value="172.16.20.66"/>
Subnet Mask:	<input type="text" value="255.255.128.0"/>
Gateway:	<input type="text" value="172.16.0.254"/>
DNS:	<input type="text" value="172.16.1.248"/>
DHCP State:	<input checked="" type="radio"/> ON <input type="radio"/> OFF

Password:

## Get Display Image

- Current display image

**GW INSTEK**  
Made to Measure

[Visit Our Site](#)

[Support](#) | [Contact Us](#)

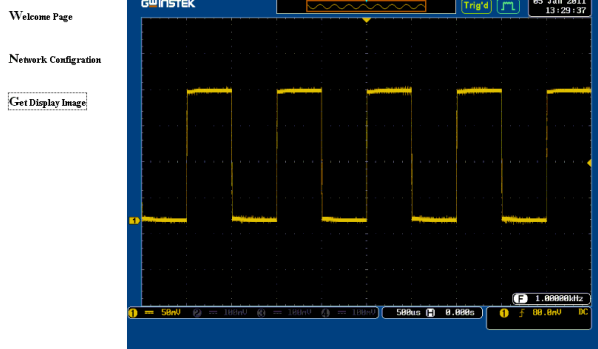

Panel Operation 1. Configure the Ethernet interface. Page 180

2. Enter the IP address of the GDS-3000 unit into the address bar of a web browser.

For example:

<http://172.16.20.255>

3. The GDS-3000 web browser welcome page appears.

**GW INSTEK**  
Made to Measure

[Visit Our Site](#)

[Support](#) | [Contact Us](#)

Welcome Page

### GDS-3000 Series Web Control Pages

Thanks For Your Using

Use the left menu  
to select the features you need.

More How-to

Please refer to user manual



### System Information

Manufacturer:	GW
Serial Number:	F930116
Description:	GW_GDS-3354
Firmware Version:	V1.08
Hostname:	G-30116
Domain Name:	
IP Address:	172.16.20.66
Subnet Mask:	255.255.128.0
Gateway:	172.16.0.254
DNS:	172.16.1.248
MAC Address:	02:50:ad:25:21:21
DHCP State:	ON

Copyright 2010 © Good Will Instrument Co., Ltd All Rights Reserved.

# M AINTENANCE

Three types of maintenance operations are available: signal path compensation, vertical accuracy calibration and probe compensation. Run these operations when using the GDS-3000 in a new environment. The maintenance chapter also includes instruction on how to install and uninstall optional software applications.

---

How to use SPC function .....	188
Vertical Accuracy Calibration .....	189
Probe Compensation .....	191
Activating Optional Software .....	192
Uninstalling Optional Software .....	193

## How to use SPC function

---

**Background** Signal Path Compensation (SPC) is used to compensate the internal signal path due to ambient temperature. SPC is able to optimize the accuracy of the oscilloscope with respect to the ambient temperature.

**Panel Operation** 1. Press the *Utility* key.



2. Press *System* from the bottom menu.

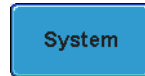

3. Press *SPC* from the side menu. A message showing a brief introduction to SPC appears on the screen.

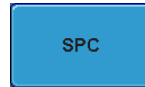

Note

Disconnect all probes and cables from all channels before calibrating.

4. Press *Start* on the side menu to start SPC calibration.



Note

The DSO needs to be warmed up for at least 30 minutes before using the SPC function.

5. The SPC Calibration will proceed one channel at a time, from channel 1 to channel 4.

## Vertical Accuracy Calibration

Panel Operation

1. Press the *Utility* key.



2. Press *System* from the bottom menu.

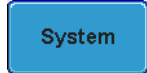

3. Press *more 1 of 2* from the side menu.

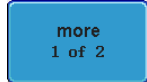

4. Press *Self Cal* on the side menu.

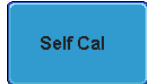

5. Press *Vertical* on the side menu.

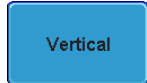

6. A message appears to "Set CAL to CH1, then press F1".

7. Connect the calibration signal from the rear panel to the Channel1 input with a BNC cable.

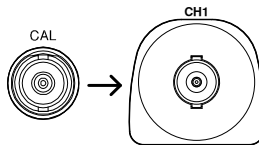



In order to avoid noise interference, it is best if you connect the BNC input channels (front) & the CAL BNC (rear) with an isolated BNC-to-BNC coaxial cable such as the RG400 BNC test lead (Part No:4241-10200201) or a normal 5D2V BNC-to-BNC coaxial cable when performing the Vertical Accuracy Calibration.

8. Press *Vertical* again after connecting CAL to the channel 1 input.

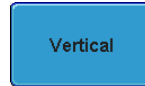

The calibration for Channel1 starts and ends automatically, in less than 5 minutes. A message is displayed when the calibration procedure has ended.

9. Repeat the above step for Channel 2, 3\* and 4\* when prompted.

\*4 channel models.

10. When the calibration for all channels has completed, the display goes back to the default state.

## Probe Compensation

- Panel Operation
1. Connect the probe between the Channel1 input and the probe compensation output (2Vp-p, 1kHz square wave) on the front panel. Set the probe attenuation to x10 (GDP probes are fixed at x10).

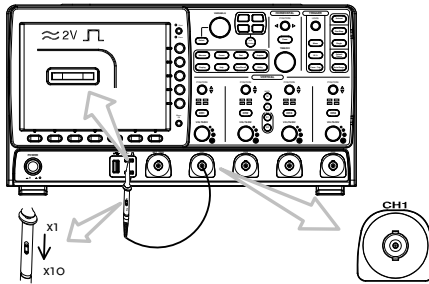

2. Press the *CH1* key to activate CH1.



3. Set the *Coupling* to DC from the bottom menu.



4. Set *Impedance* to 1MΩ from the bottom menu.



5. Set the Probe attenuation to *Voltage, 10X*.

Page 123

6. Press the *Autoset* key. The compensation signal appears on the display.



7. Press the *Display* key, then set the display type to *Vector*.



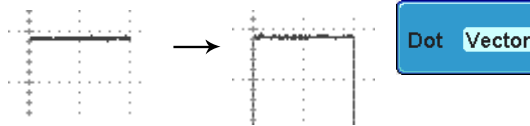

8. Turn the adjustment point on the probe to make the waveform as square as possible.

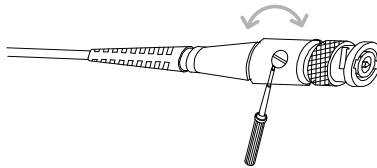
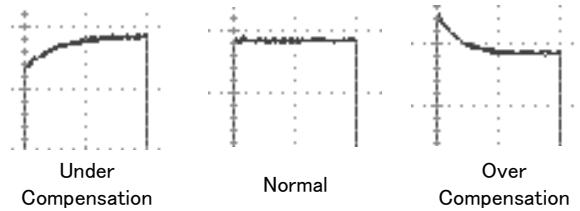

## Activating Optional Software

### Background



The GDS-3000 has power analysis software (page 95), serial bus decoding software (page 96) and other GW Instek applications as optional extras. GW Instek supplies both free-of-charge and paid-for applications.

Note: An activation key is required to activate each optional software application.

For the latest files and information regarding the optional software packages, see the GW Instek website: [www.gwinstek.com](http://www.gwinstek.com)

## Uninstalling Optional Software

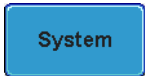
**Background** Optional software packages such as the power analysis software or the serial bus decode software can be uninstalled from the system menu.

- Panel Operation**
1. Press the *Utility* key. 
  2. Press *System* from the bottom menu. 
  3. Press more 1 of 2 from the side menu. 
  4. Press *Option Uninstall* on the side menu. 
  5. Select the optional software packages that you wish to uninstall from the side menu.



# FAQ

---

- I connected the signal but it does not appear on the display.
- I want to remove the (Measurement result / FFT result / Help contents) from the display.
- The waveform does not update (frozen).
- The probe waveform is distorted.
- Autoset does not catch the signal well.
- I can't save files to the internal memory.
- The display image printout is too dark on the background.
- The date and time setting are not correct.
- The accuracy does not match the specification.
- When trying to perform Vertical Accuracy Calibration, error messages always appear.

## I connected the signal but it does not appear on the display.

---

Make sure you have activated the channel by pressing the Channel key (the channel key lights up).

I want to remove the (Measurement result / FFT result / Help contents) from the display.

---

To clear automatic measurement results, press the Measure key, Select Remove Measurement and choose Remove All. See page 72.

To clear individual measurements from the screen, press the Measure key, select Display All and choose Display None. See page 74.

To clear FFT result, press the Math key twice. See page 82 for details.

To clear Help result, press the Help key again. See page 54 for details.

The waveform does not update (frozen).

---

Press the Run/Stop key to unfreeze the waveform. See page 59 for details.

If this does not help, the trigger mode might be set to Single. Press the Single key to exit Single mode. See page 59 for trigger setting details.

The probe waveform is distorted.

---

You might need to compensate the probe. The input impedance may also have to be changed to suit your probe. For details, see page 191. Note that the frequency accuracy and duty factor are not specified for the probe compensation waveform and therefore it should not be used for other reference purposes. Also remember to set the impedance to  $1M\Omega$ .

Autoset does not catch the signal well.

---

The Autoset function cannot catch signals under 30mV or 20Hz. Please use the manual operation. See page 58 for Autoset details.

I can't save files to the internal memory.

---

If a USB stick is inserted into one of the USB slots and you wish to save to the scope internal memory, press the *Utilities* key and set the file path to internal memory. Note however that image files can only be saved to USB when using the Print key.

The display image printout is too dark on the background.

---

Use the Ink Saver function which reverses the background color. For details, see page 174.

The date and time setting are not correct.

---

For date and time setting details, please see page 144. If it does not help, the internal battery controlling the clock might be worn out. Contact your dealer or GWInstek.

The accuracy does not match the specification.

---

Make sure the device is powered On for at least 30 minutes, within +20°C~+30°C. This is necessary to stabilize the unit to match the specification.

When trying to perform Vertical Accuracy Calibration, error messages always appear.

---

In order to avoid noise interference, it is best if you connect the BNC input channels (front) & the CAL BNC (rear) with an isolated BNC-to-BNC coaxial cable such as the RG400 BNC test lead (Part No:4241-10200201) or a normal 5D2V BNC-to-BNC coaxial cable when performing the Vertical Accuracy Calibration.

For more information, contact your local dealer or GW Instek at [www.gwinstek.com/marketing@goodwill.com.tw](http://www.gwinstek.com/marketing@goodwill.com.tw).

# APPENDIX

## GDS-3000 Specifications

The specifications apply when the GDS-3000 is powered on for at least 30 minutes under +20°C~+30°C.

### Model-specific

GDS-3152	Channels	2 + Ext
	Bandwidth	DC ~ 150MHz (-3dB)
	Rise time	2.3ns
GDS-3154	Channels	4 + Ext
	Bandwidth	DC ~ 150MHz (-3dB)
	Rise time	2.3ns
GDS-3252	Channels	2 + Ext
	Bandwidth	DC ~ 250MHz (-3dB)
	Rise time	1.4ns
GDS-3254	Channels	4 + Ext
	Bandwidth	DC ~ 250MHz (-3dB)
	Rise time	1.4ns
GDS-3352	Channels	2 + Ext
	Bandwidth	DC ~ 350MHz (-3dB)
	Rise time	1ns
GDS-3354	Channels	4 + Ext
	Bandwidth	DC ~ 350MHz (-3dB)
	Rise time	1ns
GDS-3502	Channels	2 + Ext
	Bandwidth	DC ~ 500MHz (-3dB)
	Rise time	700ps
GDS-3504	Channels	4 + Ext
	Bandwidth	DC ~ 500MHz (-3dB)
	Rise time	700ps

The bandwidth of the 75Ω input impedance is limited to 150MHz only.

Common

Vertical	Resolution	8 bit
	Sensitivity	@1MΩ: 2mV~5V/div @50/75Ω: 2mV~1V/div
	Input Coupling	AC, DC, GND
	Input Impedance	1MΩ// 15pF
	DC Gain	±3% full scale
	Accuracy	
	Polarity	Normal & Invert
	Maximum	@1 MΩ: 300Vrms, CAT I
	Input Voltage	@50/75Ω: 5 Vrms max
	Offset Position	2mV/div ~ 100mV/div : ±0.5V
	Range	200mV/div ~ 5V/div : ±25V
	Bandwidth Limit	Dependent on the oscilloscope bandwidth (BW. BW=150: Full/20MHz BW=250: Full/20MHz/100MHz BW=350: Full/20MHz/100MHz/200MHz BW=500: Full/20MHz/100MHz/200MHz/350MHz
	Waveform Signal Process	Add, subtract, multiply, and divide waveforms, FFT, FFTrms, Integration*, Differentiation* *: App installation required. FFT:Spectral magnitude. Set FFT Vertical Scale to Linear RMS or dBV RMS, and FFT Window to Rectangular, Hamming, Hanning, or Blackman-Harris.
Trigger	Sources	CH1, CH2, CH3, CH4, Line, EXT
	Modes	Auto (supports Roll Mode for 100 ms/div and slower), Normal, Single Sequence
	Type	Edge, Pulse Width(Glitch), Video, Pulse Runt, Rise & Fall(Slope), Alternate, Event-Delay(1~65535 events), Time-Delay(Duration)(10ns~10s), I <sup>2</sup> C*, SPI*, UART* *optional Runt:Trigger on a pulse that crosses one threshold but fails to cross a second threshold before crossing the first again. SPI (optional):Trigger on SS, MOSI, MISO, or MOSI and MISO on SPI buses. I <sup>2</sup> C (optional):Trigger on Start, Repeated Start, Stop, Missing ACK, Address (7 or 10 bit), Data, or Address and Data on I <sup>2</sup> C buses.

		UART (optional): Trigger on Tx Start Bit, Rx Start Bit, Tx End of Packet, Rx End of Packet, Tx Data, Rx Data, Tx Parity Error, and Rx Parity Error.
	Holdoff range	10ns to 10s
	Coupling	AC, DC, LF rej., Hf rej., Noise rej.
	Sensitivity	GDS-31XX ~ GDS-33XX: DC ~ 50MHz Approx. 1div or 10mV 50MHz ~ 150MHz Approx. 1.5div or 15mV 150MHz ~ 350MHz Approx. 2div or 20mV  GDS-350X: DC ~ 50MHz Approx. 1div or 1.0mV 50MHz ~ 150MHz Approx. 1.5div or 15mV 150MHz ~ 350MHz Approx. 2div or 20mV 350MHz ~ 500MHz Approx. 2.5div or 25mV
External Trigger	Range	±15V
	Sensitivity	GDS-31XX ~ GDS-33XX: DC ~ 150MHz Approx. 100mV 150MHz ~ 250MHz Approx. 150mV 250MHz ~ 350MHz Approx. 150mV 350MHz ~ 500MHz Approx. 200mV
	Input Impedance	1MΩ ±3%, ~1pF
Horizontal	Timebase Range	GDS-31XX, GDS-32XX, GDS-33XX: 1ns/div ~ 100s/div (1-2-5 increments); ROLL : 100ms/div ~ 100s/div  GDS-350X: 1ns/div ~ 100s/div (1-2.5-5 increments); ROLL : 100ms/div ~ 100s/div
	Pre-trigger	10 div maximum
	Post-trigger	1000 div maximum. The number of divisions depends on the time division.
	Timebase Accuracy	±20 ppm over any ≥1 ms time interval
X-Y Mode	X-Axis Input	Channel 1; Channel 3
	Y-Axis Input	Channel 2; Channel 4
	Phase Shift	±3° at 100kHz
Signal Acquisition	Real Time	150/250/300MHz models: 5GSa/s (MAX)
	Sample Rate	150/250MHz models with 2CH: 2.5GSa/s 500MHz models: 4GSa/s (MAX), 2GSa/s per channel
	ET Sample Rate	100GSa/s maximum for all models
	Record Length	25k points / channel

	Acquisition Mode	Normal, Average, Peak Detect, High Resolution, Single Sequence
	Peak (Glitch) Detection	2ns (MAX)
		Normal: Acquire sampled values. Average: From 2 to 256 waveforms included in average. Peak Detect: Captures glitches as narrow as 2 ns at all sweep speeds Hi Res: Real-time boxcar averaging reduces random noise and increases vertical resolution
Cursors and Measurement	Cursors	Amplitude, Time, Gating available
	Automatic Measurement	28 sets: Vpp, Vamp, Vavg, Vrms, Vhi, Vlo, Vmax, Vmin, Rise Preshoot/Overshoot, Fall Preshoot/Overshoot, Freq, Period, Rise Time, Fall Time, Positive Width, Negative Width, Duty Cycle, and nine different delay measurements (FRR, FRF, FFR, FFF, LRR, LRF, LFF, Phase)
	Cursors measurement	Voltage difference between cursors ( $\Delta V$ ) Time difference between cursors ( $\Delta T$ )
	Auto counter	6 digits, range from 2Hz minimum to the rated bandwidth
Power Measurements (Option)	Power Quality Measurements	V RMS, I RMS, True Power, Apparent Power, Reactive Power, Frequency, Power Factor, Phase Angle, V Crest Factor, I Crest Factor, (+)V Peak, (-)V Peak, (+)I Peak, (-)I Peak, DC Voltage, DC Current, Impedance, Resistance, Reactance
	Harmonics	Frequency (Hz), Magnitude (%), Mag. RMS (A), Phase (°), Limit (A), Limit (%), Pass   Fail, Max all , Windows (A), 200% Limit, POHC Limit, THD-F, THD-R, RMS, Overall, POHC, POHL, Input Power, Power Factor, Fundamental Current, Harmonic 3, Harmonic 5
	Ripple Measurements	Ripple, Noise
	In-rush current	First peak, Second peak
Control Panel Function	Autoset	Single-button, automatic setup of all channels for vertical, horizontal and trigger systems, with undo autoset
	Auto-Range	allow you to quickly move from test point to test point without having to reset the oscilloscope for each test point
	Save Setup	20 sets
	Save Waveform	24 sets

Display	TFT LCD Type	8" TFT LCD SVGA color display	
	Display Mode	YT, XY	
	Display Resolution	800 horizontal × 600 vertical pixels (SVGA)	
	Interpolation	Sin(x)/x & Equivalent Time Sampling	
	Waveform	Dots, vectors, variable persistence, infinite persistence	
	Display Graticule	8 x 10 divisions	
	Waveform Update Rate	3500 waveforms per second maximum	
	Interface	RS232C	DB-9 male connector
		USB Port	2 sets USB 2.0 High-speed host port 1 set USB High-speed 2.0 device port
Ethernet Port (LAN)		RJ-45 connector, 10/100Mbps	
SVGA Video Port		DB-15 female connector, monitor output for display on SVGA monitors	
GPIB		GPIB to USB adapter (Option)	
Go-NoGo BNC		5V Max, 10mA CMOS open collector output	
Internal flash disk		64MB	
Kensington Style Lock		Rear-panel security slot connects to standard Kensington-style lock.	
Line output		3.5mm stereo jack for Go/NoGo audio alarm	
Power Source		Line Voltage Range	AC 100V ~ 240V , 48Hz ~ 63Hz , Auto selection
	Power Consumption	96VA	
Miscellaneous	Multi-language menu	Available	
	On-line help	Available	
	Time clock	Time and Date ,Provide the Date/Time for saved data	
Dimensions	400W X 200H X 130D, Approx. 4kg		

## Probe Specifications

### Model-specific Probe Specifications

GTP-151R	Applicable to Bandwidth Rise time Input Capacitance Compensation Range	GDS-3152 / GDS-3154 DC ~ 150MHz 2.3ns ~12pF 10 ~ 30pF
GTP-251R	Applicable to Bandwidth Rise time Input Capacitance Compensation Range	GDS-3252 / GDS-3254 DC ~ 250MHz 1.4ns ~12pF 10 ~ 30pF
GTP-351R	Applicable to Bandwidth Rise time Input Capacitance Compensation Range	GDS-3352 / GDS-3354 DC ~ 350MHz 1.0ns ~12pF 10 ~ 30pF
GTP-501R	Applicable to Bandwidth Rise time Input Capacitance Compensation Range	GDS-3502 / GDS-3504 DC ~ 500MHz 0.7ns ~11.5pF @ 100MHz 8 ~ 20pF

## Common Probe Specifications

Position x 10	Attenuation Ratio	10:1 (fixed) with readout pin
	Input Resistance	10M $\Omega$ when used with 1M $\Omega$ input oscilloscope
	Maximum Input Voltage	500V CAT I, 300V CAT II derating with frequency
Operating Condition	Temperature	-0°C ~ 50°C
	Relative Humidity	$\leq$ 85% @35°C
Safety Standard	EN61010-031	CAT II

## GDS-3000 Dimensions

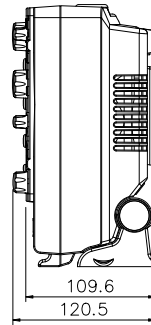
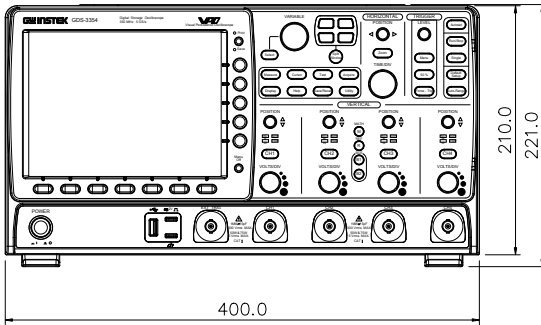
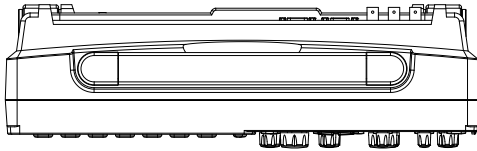

# Declaration of Conformity

We

## COMBINED TEST SOLUTIONS

declare that the below mentioned product

Type of Product: **Digital Storage Oscilloscope**

Model Number: **GDS-3152, GDS-3252, GDS-3352, GDS-3154, GDS-3254,  
GDS-3354, GDS-3502, GDS-3504**

are herewith confirmed to comply with the requirements set out in the Council Directive on the Approximation of the Law of Member States relating to Electromagnetic Compatibility (2004/108/EEC) and Low Voltage Directive (2006/95/EEC).

For the evaluation regarding the Electromagnetic Compatibility and Low Voltage Directive, the following standards were applied:

© EMC	
EN 61326-1: EN 61326-2-1:	Electrical equipment for measurement, control and laboratory use -- EMC requirements (2006)
Conducted & Radiated Emission EN 55011: 2009+A1: 2010	Electrostatic Discharge EN 61000-4-2: 2009
Current Harmonics EN 61000-3-2: 2006+A1: 2009+A2: 2009	Radiated Immunity EN 61000-4-3: 2006+A1: 2008 +A2:2010
Voltage Fluctuations EN 61000-3-3: 2008	Electrical Fast Transients IEC 61000-4-4: 2004+A1:2010
-----	Surge Immunity EN 61000-4-5: 2006
-----	Conducted Susceptibility EN 61000-4-6: 2009
-----	Power Frequency Magnetic Field EN 61000-4-8: 2010
-----	Voltage Dip/ Interruption EN 61000-4-11: 2004
Low Voltage Equipment Directive 2006/95/EEC	
Safety Requirements	EN 61010-1: 2010 (Third Edition) EN 61010-2-030: 2010 (First Edition)

# INDEX

- 2-4 channel differences ..... 11
- AC coupling ..... 118
- AC Priority mode ..... 59
- AC Priority mode ..... 61
- Acquisition ..... 100
  - indicator ..... 26
  - Sampling mode ..... 104
  - specification ..... 199
  - XY mode ..... 102
- APP.
  - Go-NoGo ..... 90
  - overview ..... 87
  - run ..... 87
  - uninstall ..... 88
- Auto trigger ..... 127
- Automatic measurement
  - display all ..... 74
  - gated mode ..... 73
  - individual mode ..... 71
  - overview ..... 68
  - remove measurement ..... 72
- Auto-range ..... 60
  - AC Priority mode ..... 61
  - exception ..... 61
  - Fit Screen mode ..... 61
- Autoset ..... 58
  - AC Priority mode ..... 59
  - effect on channel ..... 58
  - exception ..... 59
  - Fit Screen mode ..... 59
- Average voltage measure ..... 69
- Bandwidth filter ..... 120
- Blackman window ..... 83
- Built-in help ..... 54
- Buzzer ..... 144
- Calibration, accuracy resolution ..... 189
- Caution symbol ..... 5
- Channel ..... 57
  - status indicator ..... 27
- Cleaning the instrument ..... 7
- Control panel function
  - specification ..... 200
- Convention
  - menu tree ..... 38
- Conventions ..... 32
- Coupling mode ..... 118
- Cursor
  - horizontal ..... 76
  - specification ..... 200
  - vertical ..... 79
- Cycle time measure ..... 69
- Date setting ..... 144
  - indicator ..... 26
- DC coupling ..... 118
- Declaration of conformity ..... 205
- Default setup ..... 160
  - contents ..... 52, 149, 161
  - effect on channel ..... 58
- Delay measure ..... 70
- Delay trigger ..... 134
- Deskew ..... 124
- Dimensions
  - diagram ..... 204
  - specification ..... 201
- Display
  - diagram ..... 25
  - specification ..... 201
- Disposal instructions ..... 8
- Dots ..... 106
- Download information ..... 16
- Duty cycle measure ..... 69
- Edge Trigger ..... 132
- EN61010
  - measurement category ..... 6
  - pollution degree ..... 7
- Environment

safety instruction .....	7	Image file format .....	147
Equivalent time sampling.....	105	Impedance.....	119
Erase memory .....	143	Initialization.....	30
Ethernet		Input frequency indicator .....	26
interface.....	180	Intensity.....	107
Expand by ground/center.....	121	color .....	109
External trigger .....	127	gray .....	109
input terminal .....	22	Interface.....	178
specification.....	199	specification.....	201
Falling time measure .....	69	Invert waveform .....	119
FAQ .....	194	Keys overview .....	18
FFT .....	85	Labels.....	151
horizontal cursor .....	77	Language selection .....	142
Overview .....	82	List of features .....	12
vertical cursor .....	80	Logic trigger .....	140
File		Low voltage measure .....	69
copy .....	173	Math.....	82
create folder.....	169	basic .....	83
delete .....	172	FFT .....	85
rename.....	170	Memory bar	
File navigation.....	168	indicator .....	26
File path .....	168	Menu on/off .....	111
Firmware version.....	143	Miscellaneous	
First time use .....	30	specification.....	201
Fit Screen mode.....	59	Model difference .....	11
Fit Screen mode.....	61	Normal trigger.....	127
Frequency measure .....	69	NTSC .....	129
Front panel diagram.....	17	On-screen help .....	54
Go-NoGo.....	90	Optional software	
circuit diagram.....	94	activation .....	192
timing .....	93	uninstall .....	193
GPIO		Overshoot voltage measure.....	69
interface.....	183	Package contents .....	16
Ground		PAL .....	129
coupling .....	118	Pc software download.....	16
symbol .....	5	PC software download.....	184
terminal .....	22	Peak voltage measure.....	68
Hamming window .....	83	Persistence.....	107
Hanning window.....	82	Power Analysis.....	95
High voltage measure .....	69	overview .....	95
Holdoff.....	101, 131	Power measurements	
Horizontal		specification.....	200
basic operation.....	63	Power on/off	
position.....	112	safety instruction.....	7
scale .....	113	Power source	
specification.....	199	specification.....	201

Preshoot voltage measure .....	69	Service operation	
Printing		about disassembly .....	6
connection .....	174	contact .....	196
ink saver .....	176	Setup	
print/save key .....	175	default contents .....	52
Printing .....	174	file format .....	149
Probe		Signal path comensation.....	188
attenuation level .....	123	Single trigger mode .....	127
attenuation type .....	122	with run/stop .....	62
deskew .....	124	Software activation .....	192
package list .....	16	SPC .....	188
specification .....	202	Specifications .....	197
Probe compensation .....	191	Split Window	
Program manual download .....	16	active window .....	67
Pulse runt trigger .....	138	operation .....	66
Pulse time measure .....	69	reference position .....	67
Pulse width trigger .....	135	Spreadsheet file format .....	148
Real time sampling .....	105	Stop icon .....	62
Rear panel diagram .....	23	System information .....	142
Recall .....	160	Tilt stand .....	28
default setup .....	160	Time setting .....	144
reference .....	165	indicator .....	26
setup .....	162, 163	Trigger .....	125
waveform .....	162	delay .....	134
Rectangular window .....	83	edge .....	132
Reduce menu .....	34	holdoff .....	131
Remote control .....	177	indicator .....	26
interface configuration .....	178	Logic .....	140
webservice .....	184	mode .....	132
Rising time measure .....	69	parameters .....	127
Roll mode .....	114	pulse runt .....	138
RS-232C		pulse width .....	135
interface .....	179	single trigger with run/stop .....	62
Run/stop .....	62	specification .....	198
Run/Stop .....	111	status indicator .....	27
horizontal position .....	112	video .....	137
Horizontal scale .....	113	UK power cord .....	9
Save .....	153	Uninstall applications .....	88
image .....	154	Uninstall optional software .....	193
print/save key .....	155	USB	
setup .....	158	driver download .....	16
waveform .....	157	remote control interface .....	178
SECAM .....	129	Vectors .....	106
Serial bus		Vertical .....	117
overview .....	96	accuracy calibration .....	189
Serial Bus .....	96	basic operation .....	65
Serial number .....	143	position .....	117

---

scale .....	117	invert waveform .....	119
specification.....	198	roll mode.....	114
Video trigger .....	137	zoom mode.....	115
Warning symbol .....	5	Waveform color.....	25
Waveform		Waveform file format .....	147
data contents .....	148	XY	
file contents .....	148	specification.....	199
how to recall.....	162	Zoom waveform.....	115
how to save.....	157		

Combined Test Solutions,  
4 Commerce Way, Stanbridge Road,  
Leighton Buzzard, LU7 4RW

T: 01525 374466  
E: [sales@ctstest.co.uk](mailto:sales@ctstest.co.uk)  
W: [www.ctstest.co.uk](http://www.ctstest.co.uk)

