



# DC POWER SUPPLY

GPR-MIDDLE SERIES  
(ANALOG / DIGITAL TYPE)

## SAFETY TERMS AND SYMBOLS

These terms may appear in this manual or on the product:



**WARNING.** Warning statements identify condition or practices that could result in injury or loss of life.



**CAUTION.** Caution statements identify conditions or practices that could result in damage to this product or other property.

The following symbols may appear in this manual or on the product:



**DANGER**  
High Voltage



**DANGER**  
Hot Surface



**ATTENTION**  
refer to Manual



**Protective**  
Conductor  
Terminal



**Equipotentiality**

# CONTENTS

SECTION	PAGE
1. INTRODUCTION .....	1
2. SPECIFICATIONS .....	2
2-1 General .....	2
2-2 Constant Voltage Operation .....	3
2-3 Constant Current Operation .....	3
2-4 Indicator Meter .....	3
2-5 Insulation .....	4
3. THEORY OF OPERATION .....	4
4. PANEL CONTROLS AND INDICATORS .....	6
4-1 Front Panel .....	6
4-2 Rear Panel .....	6
5. OPERATION INSTRUCTIONS .....	10
5-1 Precaution .....	10
5-2 Setting Current Limit .....	10
5-3 Constant Voltage/Constant Current Characteristic .....	10
5-4 Operation Mode .....	11
6. MAINTANCE .....	13
6-1 Fuse Replacement .....	13
6-2 Line Voltage Conversion .....	13
6-3 Adjustments .....	13
6-4 Cleaning .....	14

## 1. INTRODUCTION

The regulated DC power supply have been designed to provide the most often required in the laboratory, schools and production lines.

The output voltage is continuously adjustable between 0 to rating voltage in one range by means of a coarse and fine potentiometer, the load current may have any value from 0 to rating current and adjusted by means of a coarse and fine potentiometer. Both outputs can accurately read on voltmeter and ammeter.

Both stability and ripple are extremely good to meet the requirements of modern circuit design. The unit can be used as either constant voltage or current source. The various operation mode are described in more detail in the Operation Instruction section.

For applications when outputs greater than rating V is need, the unit can be connected up in series.

For applications in audio production lines, the continuous or dynamic load internal selectable.



## 2-2 Constant Voltage Operation

- (1) Output voltage ranges o-rating voltage continuously adjustable.
- (2) Voltage regulation  
line regulation  $\leq 0.01\% + 3\text{mV}$   
load regulation  $\leq 0.01\% + 5\text{mV}$   
load regulation  $\leq 0.02\% + 5\text{mV}$  ( $\geq 10\text{A}$ )
- (3) Recovery time  $\leq 100\ \mu\text{s}$ . (50% load change, minimum load 0.5A)
- (4) Ripple & Noise  $\leq 1\text{mV rms}$  (5Hz~1MHz)
- (5) Temperature coefficient  $\leq 300\text{PPM}/^\circ\text{C}$

## 2-3 Constant Current Operation

- (1) Output current range 0 to rating current continuously adjustable.
- (2) Current regulation  
line regulation  $\leq 0.2\% + 3\text{mA}$   
load regulation  $\leq 0.2\% + 3\text{mA}$
- (3) Ripple current  $\leq 3\text{mA rms}$

## 2-4 Indicator Meter

- (1) Digital Type  
Display:  $3\frac{1}{2}$  Digits 0.5" Red LED Display.  
Accuracy:  $\pm(0.5\%$  of rdg + 2 digits)  
Voltage range: 19.99V of full scale (rating voltage  $\leq 18\text{V}$ ).  
199.9V of full scale (rating voltage  $\geq 20\text{V}$ )  
Current range: 1.999A of full scale (rating current  $< 2\text{A}$ ).  
19.99A of full scale (rating current  $\geq 2\text{A}$ ).
- (2) Analog Type  
Meter: Voltmeter and Ammeter each one  
Class: 2.5  
Dimensions: 60x80 m/m

## 2-5 Insulation

Between chassis and output terminal

20M $\Omega$  or above (DC 500V)

Between chassis and AC cord

30M $\Omega$  or above (DC 500V)

## 3. THEORY OF OPERATION

The power supply consists of an AC input circuit and transformer, a bias supply consisting of a rectifier and filter and reference voltage source, a main regulator circuit consisting of the main rectifier and filter, a series regulator, a current comparator, a voltage comparator, a reference voltage amplifier, a tag a instant over load protection circuit and a relay control circuit.

The circuit element are several of integrated circuit (U201, U202, U203, U204, U101).

The circuit arrangement is shown in block diagram from Fig. 1.

The circuit is discussed with reference to the block diagram Function Description.

Single phase input power is applied to transformer through the input circuit.

Auxiliary rectifier D102A~D provides a bias voltage filtered by capacitor C103, C104 for the preregulator U101, Q101, Q102, that provides a regulator voltage for element of action.

The main rectifier, a full wave bridge rectifier, provides the power which is filtered by capacitor C101, C102 and then regulated via a series regulator and deliver to the output.

U204 acted as a current limiter. When current is over predominate rating, it acted and decreased the current. U201 provides a reference voltage for U202, U204. U202 is a inverter amplifier, U204 is a comparator amplifier. It's may be made comparator for reference voltage and detector feedback voltage, and then deliver to Q201, Q202, this time output voltage is calibrated.

Q204 is instant over load protection circuit, Q204 turn on when voice response load adds at instant. It controls Q201 current magnitude of  $I_B$  makes output current limited.

The relay control circuit provides limited power dissipation in series regulator.

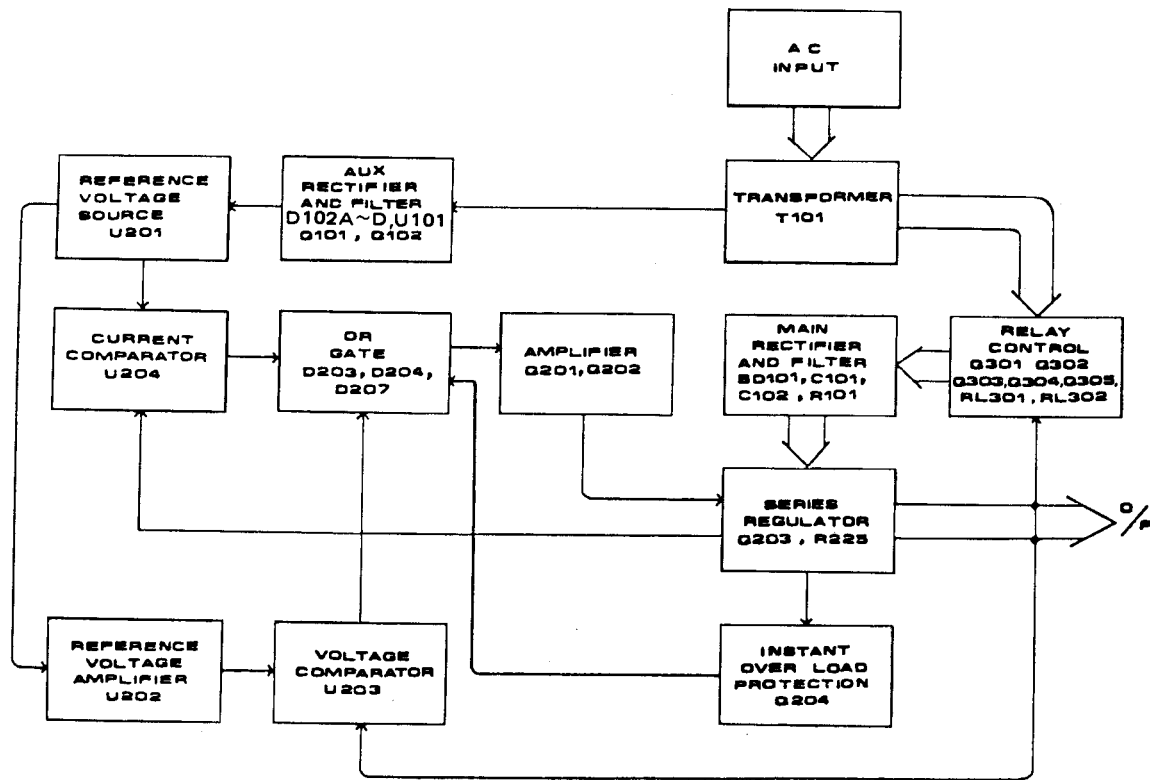

Fig. 1 Block Diagram

## 4. PANEL CONTROLS AND INDICATORS

### 4-1 Front panel

- |                       |  |
|-----------------------|--|
| ① CV indicator        | lights when the power turn on and constant voltage operation.      |
| ② CC indicator        | lights when this unit in constant current operation.               |
| ③ Voltage coarse      | for the coarse adjustment of the output voltage.                   |
| ④ Voltage fine        | for the fine adjustment of the output voltage.                     |
| ⑤ Current coarse      | for the coarse adjustment of the output current.                   |
| ⑥ Current fine        | for the fine adjustment of the output current.                     |
| ⑦ "+" output terminal | positive polarity. (Red)   |
| ⑧ "GND" terminal      | Earth and chassis ground (green).                                  |
| ⑨ "-" output terminal | negative polarity. (Black)   |
| ⑩ Voltmeter           | indicates the output voltage (Digital panel meter or Analog meter) |
| ⑪ Ammeter             | indicates the output current (Digital panel meter or analog meter) |
| ⑫ Power control       | on/off switch.   |

### 4-2 Rear panel

- |                     |  |
|---------------------|--|
| ⑬ Fuse holder       |  |
| ⑭ Power cord        |  |
| ⑮ HI-LO switch      | HI position selects high voltage range (120V, 240V AC inputs), LO position selects low voltage range (100V, 220V AC inputs). |
| ⑯ AC selects switch | With ⑮ HI-LO switch selects to permit operation from 100, 120, 220 or 240VAC, 50/60HZ line voltage.                          |

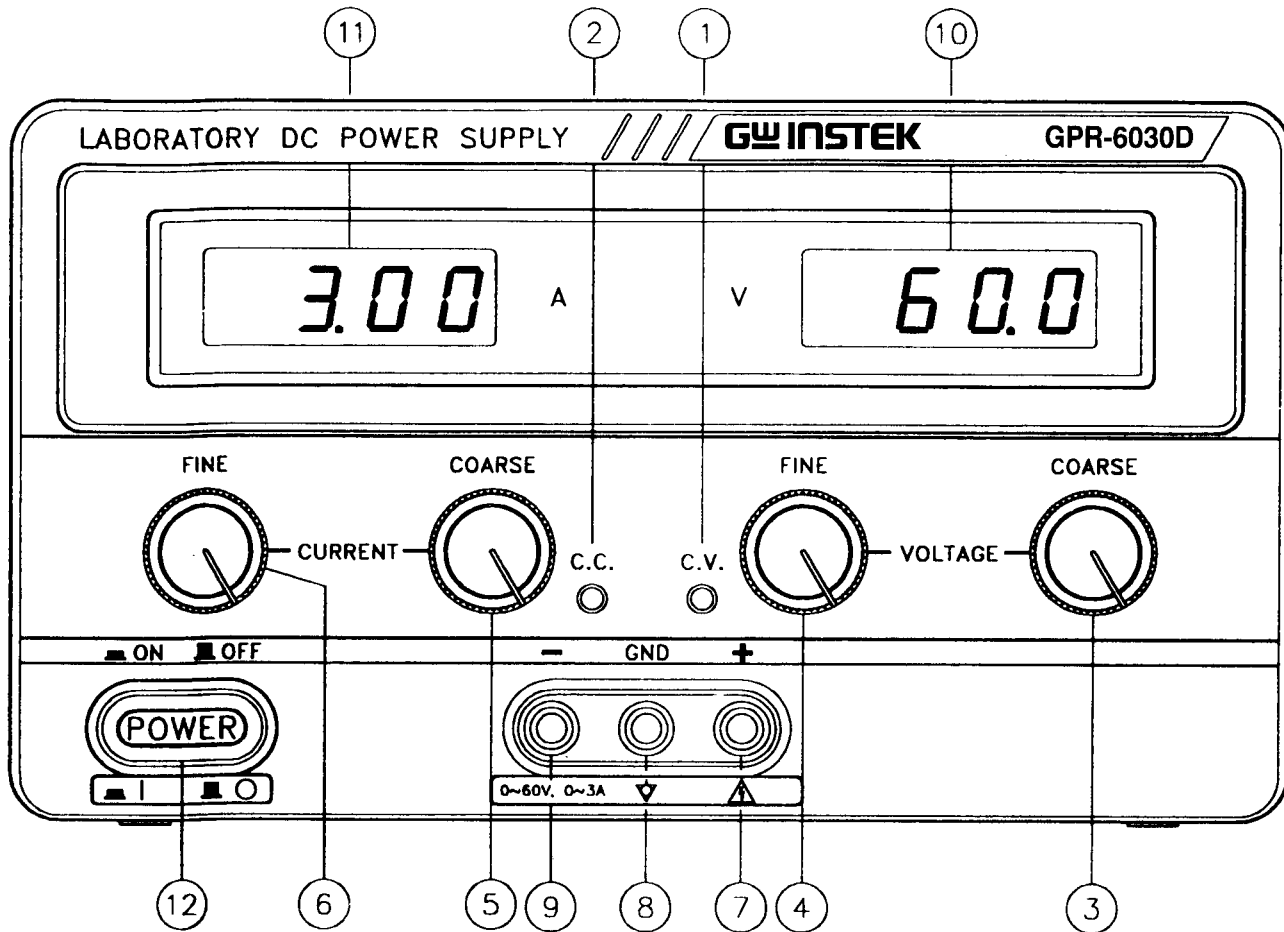

Fig. 4-1 Front Panel (Digital Type)

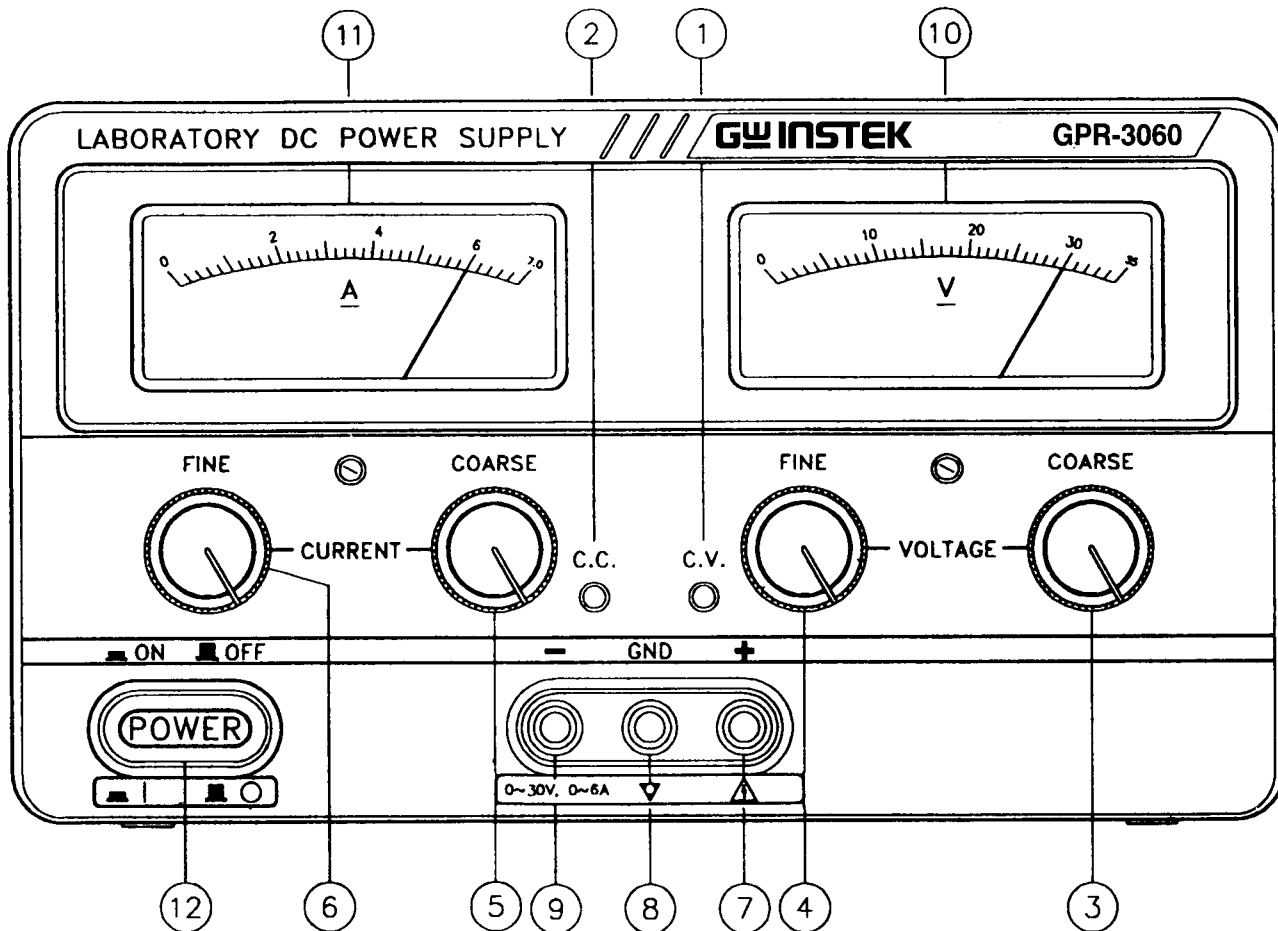

Fig. 4-2 Front Panel (Analog Type)

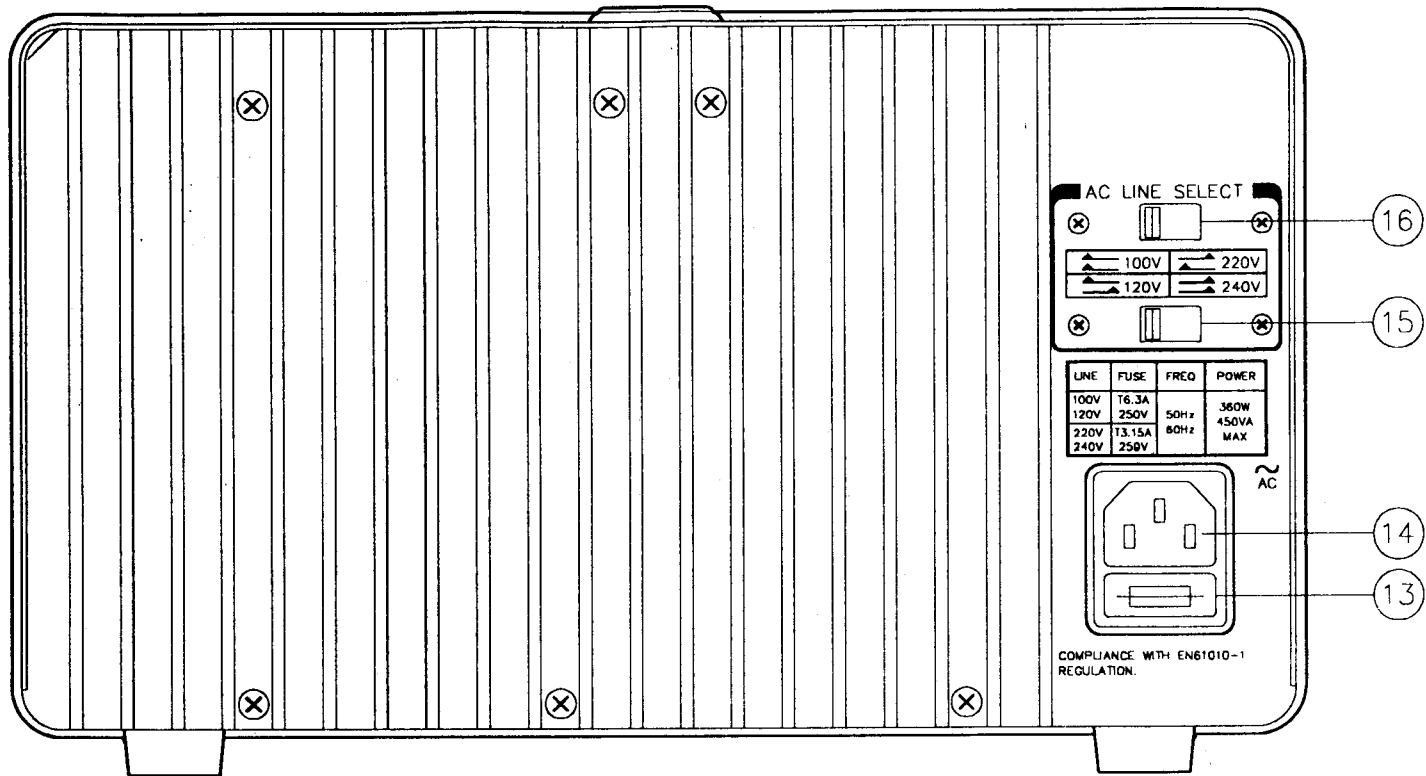

FIG. 4.3. REAR PANEL

## 5. OPERATION INSTRUCTIONS

### 5-1 Precaution

#### (1) AC input

AC input should be within the range of line voltage  $\pm 10\%$  50/60Hz.



**WARNING.** To avoid electrical shock, the power cord protective grounding conductor must be connected to ground.

#### (2) Installation

Avoid using the supply in a place where the ambient temperature exceeds 40°C. The heat sink located at the rear of the supply must have sufficient air space for radiation.



**CAUTION.** To avoid damaging the power supply, don't use it in a place where ambient temperature exceeds 40°C.

#### (3) Output voltage overshoot

Voltage between output terminals never exceeds the preset value when the power is turned on or off.

### 5-2 Setting Current Limit

(1) Determine the maximum safe current for the device to be powered.

(2) Temporarily short the (+) and (-) terminals of the power supply together with a test lead.

(3) Rotate the COARSE VOLTAGE control away from zero sufficiently for the CC indicator to light.

(4) Adjust the CURRENT control for the desired current limit. Read the current value on the Ammeter.

(5) The current limit (overload protection) has now been preset. Do not change the CURRENT control setting after this step.

(6) Remove the short between the (+) and (-) terminals and hook up for constant voltage operation.

### 5-3 Constant Voltage/Constant Current Characteristic

The working characteristic of this series Power Supplies is called a constant voltage/constant current automatic cross-over type. This permits continuous transition from constant current to constant voltage modes in response to the load change. The intersection of constant voltage and constant current modes is called the crossover point. Fig. 5-1 shows the relationship between this crossover point and the load.

For example, if the load is such that the power supply is operating in the constant voltage mode, a regulated output voltage is provided. The output voltage remains constant as the load increases, up until the point where the preset current limit is reached. At that point, the output current becomes constant and the output voltage drops in proportion to further

increases in load. The crossover point is indicated by the front panel LED indicators. The crossover point is reached when the CV indicator goes off and the CC indicator comes on.

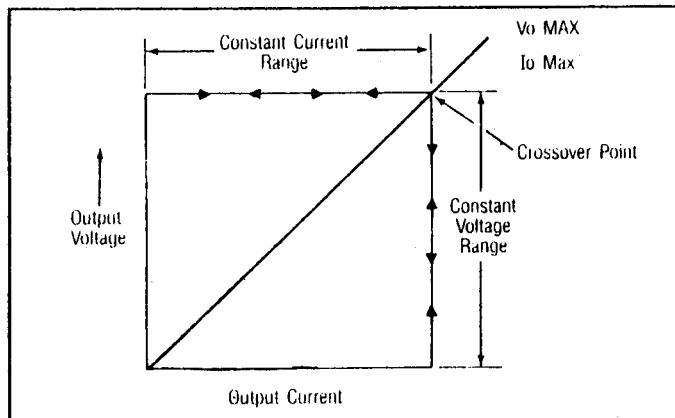

Fig. 5-1 Constant Voltage/Constant Current Characteristic.

Similarly, crossover from the constant current to the constant voltage mode automatically occurs from a decrease in load. A good example of this would be seen when charging a 12-volt battery. Initially, the open circuit voltage of the power supply may be preset for 13.8 volts. A low battery will place a heavy load on the supply and it will operate in the constant current mode, which may be adjusted for a 1 amp charging rate. As the battery becomes charged, and its voltage approaches 13.8 volts, its load decreases to the point where it no longer demands the full 1 amp charging rate. This is the crossover point where the power supply goes into the constant voltage mode.

#### 5-4 Operation Mode

##### (1) Single Operation

Use the supply as it is for single operation.

- A. Set Power switch to "OFF" position.
- B. Make sure that line voltage is correct for the input power voltage.
- C. Plug power cord into the power outlet.
- D. Set Power switch to "ON" position.
- E. Adjust "Voltage" and "Current" control to the desired output voltage and current.
- F. Connect the external load to the output binding posts. Make sure both "+" and "-" terminals are connected correctly.

(2) Series Operation

Two power supplies may be connected in series to provide higher voltage and rating current output. See Fig. 5-2 for the connection scheme.

When connected in series, the VOLTAGE controls of each power supply exercise control over a 0 to rating range. Add the two voltmeter readings together to determine the total output voltage, or an external voltmeter may be connected across the load.

Load current may be monitored from either supply; the readings will be identical since they are connected in series. Also, since the supplies are connected in series, it is only necessary to set the current limit on one of the supplies; the other may be set for maximum.

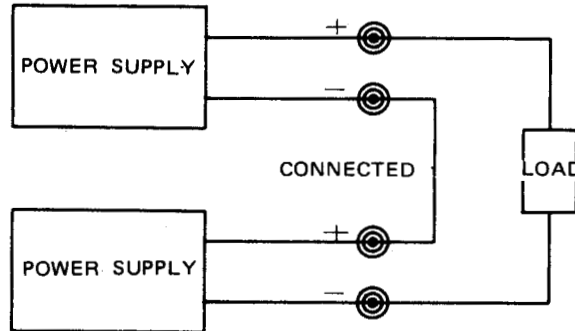

Fig. 5-2 Connecting Two Power Supplies in Series.

## 6. MAINTENANCE

### WARNING

The following instructions are for use by qualified personnel only. To avoid electrical shock, do not perform any servicing other than contained in the operating instructions unless you are qualified to do so.

#### 6-1 Fuse Replacement

If the fuse blows, the CV or CC indicators will not light and the power supply will not operate. The fuse should not normally open unless a problem has developed in the unit. Try to determine and correct the cause of the blown fuse, then replace only with a fuse of the correct rating and type.

The fuse is located on the rear panel (see Fig. 4-3).



**WARNING.** For continued fire protection. Replace fuse only with 250V fuse of the specified type and rating, and disconnect the power cord before replacing fuse.

#### 6-2 Line Voltage Conversion

The primary winding of the power transformer is tapped to permit operation from 100, 120, 220, or 240 VAC, 50/60 Hz line voltage. Conversion from one line voltage to another is done by change AC selects switch as shown in Fig. 4-3.

The rear panel identifies the line voltage to which the unit was factory setted. To convert to a different line voltage, perform the following procedure:

- (1) Make sure the power cord is unplugged.
- (2) Change the AC selects switch to the desired line voltage position.
- (3) A change in line voltage may also require a corresponding change of fuse value. Install the correct fuse value as listed on rear panel.

#### 6-3 Adjustments

This unit was accurately adjusted at the factory before shipment. Readjustment is recommended only if repairs have been made in a circuit affecting adjustment accuracy, or if you have a reason to believe the unit is out of adjustment. However, adjustments should be attempted only if a multimeter with an accuracy of  $\pm 0.1\%$  dcv or better is available (GOOD WILL Model GDM- 8135 or equivalent).

If readjustment is required, use the following procedure. Locations of the adjustments are shown in Fig. 6-1 and FIG. 6-2.

(1) Adjustment of the Rating Voltage

- A. Connect an accurate ( $\pm 0.1\%$ ) external multimeter to measure the dc voltage at output terminals of the power supply.
- B. Set the COARSE and FINE VOLTAGE controls to minimum (fully counterclockwise).
- C. Adjust trimmer pot VR204 for a reading of 0 volts on the multimeter.
- D. Turn the COARSE and FINE VOLTAGE controls to maximum (fully clockwise).
- E. Adjust trimmer pot VR201 for a reading of rate volts  $\times 1.05$  on the multimeter.
- F. Set the COARSE and FINE VOLTAGE controls for a reading of rate volts on the multimeter.
- G. Adjust trimmer pot VR207 (VR201 digital type) for a reading of rate volts on the volt meter (Digital Panel meter, digital type) of the power supply.

(2) Adjustment of the Rating Current

- A. Set the CURRENT control to minimum (fully counterclockwise).
- B. Connect the external multimeter to measure dc current at the output terminals of the power supply.
- C. Set the COARSE and FINE CURRENT controls to minimum (fully counterclockwise).
- D. Adjust trimmer pot VR301 for reading of 0 amps on the multimeter.
- E. Set the COARSE and FINE VOLTAGE controls to a centered position.
- F. Setting and turn the COARSE and FINE CURRENT controls to maximum (fully clockwise).
- G. Adjust trimmer pot VR205 for a reading of rate amps  $\times 1.05$  on the multimeter.
- H. Readjust the CURRENT control for a reading of rate amps on the multimeter.
- I. Adjust trimmer pot VR208 (VR202 digital type) to calibrate the Ammeter (Digital panel meter, digital type) of the power supply for the same reading as the multimeter.

#### 6.4 Cleaning

To clean the power supply, use a soft cloth dampened in a solution of mild detergent and water. Do not spray cleaner directly onto the instrument, since it may leak into the cabinet and cause damage. Do not use chemicals containing benzene, benzene, toluene, xylene, acetone, or similar solvents. Do not use abrasive cleaners on any portion of the instrument.



VR602



VR201

FIG. 6-1

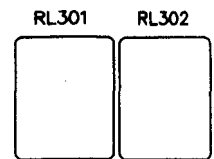
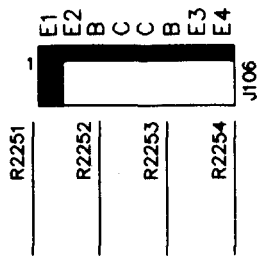
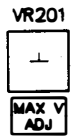
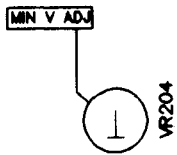

FIG. 6-2

## FOR UNITED KINGDOM

### NOTE

This lead/appliance must only be wired by competent persons

### WARNING

THIS APPLIANCE MUST BE  
EARTHED  
IMPORTANT

The wires in this lead are coloured in accordance with the following code:

Green/  
Yellow: Earth  
Blue: Neutral  
Brown: Live(Phase)

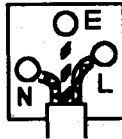

As the colours of the wires in main leads may not correspond with the colours marking identified in your plug/appliance, proceed as follows:

The wire which is coloured Green & Yellow must be connected to the Earth terminal marked with the letter E or by the earth symbol  $\perp$  or coloured Green or Green & Yellow.

The wire which is coloured Blue must be connected to the terminal which is marked with the letter N or coloured Blue or Black.

The wire which is coloured Brown must be connected to the terminal marked with the letter L or P or coloured Brown or Red.

If in doubt, consult the instructions provided with the equipment or contact the supplier.

This cable/appliance should be protected by a suitably rated and approved HBC mains fuse : refer to the rating information on the equipment and/or user instructions for details. As a guide, cable of  $0.75\text{mm}^2$  should be protected by a 3A or 5A fuse. Larger conductors would normally require 13A types, depending on the connection method used.

Any moulded mains connector that requires removal/replacement must be destroyed by removal of any fuse & fuse carrier and disposed of immediately, as a plug with bared wires is hazardous if engaged in a live socket. Any re-wiring must be carried out in accordance with the information detailed on this label.

## EC Declaration of Conformity

We

### COMBINED TEST SOLUTIONS

Declare that the below mentioned products

**GPR-1810H, GPR-1810HD, GPR-3060, GPR-3060D, GPR-6030, GPR-6030D**

are herewith confirmed to comply with the requirements set out in the Council Directive on the approximation of the Law of Member States relating to Electromagnetic Compatibility (89/336/EEC, 92/31/EEC, 93/68/EEC) and Low Voltage Equipment Directive (73/23/EEC, 93/68/EEC). For the evaluation regarding the Electromagnetic Compatibility and Low Voltage Equipment Directive, the following standards were applied:

**EN 61326-1: Electrical equipment for measurement, control and laboratory use—**

**EMC requirements (1997 + A1:1998)**

Conducted Emission	EN 55022 class B (1994)	Electrostatic Discharge	IEC 1000-4-2	(1995)
Radiated Emission	EN 55011 class B (1991)	Radiated Immunity	IEC 1000-4-3	(1995)
Current Harmonics	EN 61000-3-2 (1996)	Electrical Fast Transients	IEC 1000-4-4	(1995)
Voltage Fluctuations	EN 61000-3-3 (1995)	Surge Immunity	IEC 1000-4-5	(1995)
-----	-----	-----	Conducted Susceptibility	EN 61000-4-6 (1996)
-----	-----	-----	Power Frequency Magnetic Field	EN 61000-4-8 (1993)
-----	-----	-----	Voltage Dip/Interruption	EN 61000-4-11 (1994)

### Low Voltage Directive 73/23/EEC & 93/68/EEC

Low Voltage Directive

|| IEC/EN 61010-1:2001

Combined Test Solutions,  
4 Commerce Way, Stanbridge Road,  
Leighton Buzzard, LU7 4RW

T: 01525 374466  
E: [sales@ctstest.co.uk](mailto:sales@ctstest.co.uk)  
W: [www.ctstest.co.uk](http://www.ctstest.co.uk)

