



Spectrum Analyzer

GSP-818 Series

USER MANUAL



ISO-9001 CERTIFIED MANUFACTURER

This manual contains proprietary information, which is protected by copyright. All rights are reserved. No part of this manual may be photocopied, reproduced or translated to another language without prior written consent of the Combined Test Solutions.

The information in this manual was correct at the time of printing. However, Good Will continues to improve products and reserves the right to change specification, equipment, and maintenance procedures at any time without notice.

Table of Contents

SAFETY INSTRUCTIONS	5
USER NOTICE	10
General Inspection	10
Safety Precaution before Operation	11
Electro-static Discharge (ESD) Protection	12
First Time to Power on	13
GETTING STARTED	14
Package Contents and Accessories	15
Front Panel Overview.....	16
Rear Panel	18
Front Panel Function Key	20
Parameter Input	23
User Interface.....	25
Build-in Help	27
Basic Measurement	27
MENU INTEPRETATION	31
Frequency	35
Span	39
Amplitude.....	41
Auto Tune	45
Bandwidth/Average.....	46
Trace.....	48
Detector	50
Display	52
Sweep	54
Trigger	55
Tracking Generator	56
Demodulation.....	58

Peak Search	60
Marker	62
Marker→	66
Marker Function	68
Measurement.....	70
Measure Setup.....	74
System	75
File	78
Quick Save.....	79
Save.....	79
FAQ.....	80
APPENDIX.....	82
Specifications	82
GSP-818 Factory Default Settings.....	87
Declaration of Conformity.....	90

S SAFETY INSTRUCTIONS

This chapter contains important safety instructions that you must follow when operating the GSP-818, and when keeping it in storage. Read the following before operating the GSP-818 to ensure your safety and to keep the GSP-818 series in the best possible condition.

Safety Symbols

These safety symbols may appear in this manual or on the GSP-818.



Warning: Identifies conditions or practices that could result in injury or loss of life.



Caution: Identifies conditions or practices that could result in damage to the GSP-818 or to other properties.



DANGER High Voltage



Attention Refer to the Manual



Protective Conductor Terminal



Earth (ground) Terminal



Do not dispose electronic equipment as unsorted municipal waste. Please use a separate collection facility or contact the supplier from which this instrument was purchased.

Safety Guidelines

General Guideline



CAUTION

- Do not place any heavy object on the GSP-818.
- Avoid severe impact or rough handling that leads to damaging the GSP-818.
- Do not discharge static electricity to the GSP-818.
- Do not block or obstruct the cooling fan vent openings.
- Do not perform measurement at circuits directly connected to Mains (Note below).
- Do not disassemble the GSP-818 unless you are qualified as service personnel.
- The equipment is not for measurements performed for CAT II, III and IV.

(Measurement categories) EN 61010-1:2010 specifies the measurement categories and their requirements as follows. The GSP-818 falls under category I.

- Measurement category IV is for measurement performed at the source of low-voltage installation.
 - Measurement category III is for measurement performed in the building installation.
 - Measurement category II is for measurement performed on the circuits directly connected to the low voltage installation.
 - 0 is for measurements performed on circuits not directly connected to Mains.
-

Power Supply



WARNING

- AC Input voltage range: 100-240Vac;
Frequency: 50/60Hz
 - Connect the protective grounding conductor of the AC power cord to an earth ground, to avoid electrical shock.
-

Cleaning the GSP-818

- Disconnect the power cord before cleaning.
 - Use a soft cloth dampened in a solution of mild detergent and water. Do not spray any liquid.
 - Do not use chemicals or cleaners containing harsh material such as benzene, toluene, xylene, and acetone.
-

Operation Environment

- Location: Indoor, no direct sunlight, dust free, almost non-conductive pollution (Note below)
- Temperature: 0°C to 40°C
- Altitude: Up to 2000m
- Transient Overvoltage on the main supply is 2500V.

(Pollution Degree) EN 61010-1:2010 specifies the pollution degrees and their requirements as follows. THE GSP-818 falls under degree 2.

Pollution refers to “addition of foreign matter, solid, liquid, or gaseous (ionized gases), that may produce a reduction of dielectric strength or surface resistivity”.

- Pollution degree 1: No pollution or only dry, non-conductive pollution occurs. The pollution has no influence.
 - Pollution degree 2: Normally only non-conductive pollution occurs. Occasionally, however, a temporary conductivity caused by condensation must be expected.
 - Pollution degree 3: Conductive pollution occurs, or dry, non-conductive pollution occurs which becomes conductive due to condensation which is expected. In such conditions, equipment is normally protected against exposure to direct sunlight, precipitation, and full wind pressure, but neither temperature nor humidity is controlled.
-

Storage environment

- Location: Indoor
- Relative Humidity: < 80%
- Temperature: -20°C to 70°C

Disposal



Do not dispose this instrument as unsorted municipal waste. Please use a separate collection facility or contact the supplier from which this instrument was purchased. Please make sure discarded electrical waste is properly recycled to reduce environmental impact.

Power cord for the United Kingdom

When using the GSP-818 in the United Kingdom, make sure the power cord meets the following safety instructions.

NOTE: This lead/appliance must only be wired by competent persons



WARNING: THIS APPLIANCE MUST BE EARTHED

IMPORTANT: The wires in this lead are coloured in accordance with the following code:

Green/ Yellow: Earth
Blue: Neutral
Brown: Live (Phase)



As the colours of the wires in main leads may not correspond with the coloured marking identified in your plug/appliance, proceed as follows:

The wire which is coloured Green & Yellow must be connected to the Earth terminal marked with either the letter E, the earth symbol (⊕) or coloured Green/Green & Yellow.

The wire which is coloured Blue must be connected to the terminal which is marked with the letter N or coloured Blue or Black.

The wire which is coloured Brown must be connected to the terminal marked with the letter L or P or coloured Brown or Red.

If in doubt, consult the instructions provided with the equipment or contact the supplier.

This cable/appliance should be protected by a suitably rated and approved HBC mains fuse: refer to the rating information on the equipment and/or user instructions for details. As a guide, a cable of 0.75mm² should be protected by a 3A or 5A fuse. Larger conductors would normally require 13A types, depending on the connection method used.

Any exposed wiring from a cable, plug or connection that is engaged in a live socket is extremely hazardous. If a cable or plug is deemed hazardous, turn off the mains power and remove the cable, any fuses and fuse assemblies. All hazardous wiring must be immediately destroyed and replaced in accordance to the above standard.

USER NOTICE

This chapter helps you in preparing the spectrum analyzer for use and provides the information to start using the spectrum analyzer correctly.

General Inspection

When you receive your new instrument, it is recommended that you check the instrument following these steps:

Steps

1. Check for transportation damage.
If it is found that the packaging carton or the foamed plastic protection cushion has suffered serious damage, do not throw it away until the complete device and its accessories have been electrically and mechanically checked.
2. Check the Accessories
Please ensure that all the listed accessories are present and undamaged, if any problems are found please contact your distributor.
3. Check the Complete Instrument
If there is any physical damage, operational fault, or performance issue please contact your distributor or GW Instek's local office. If there is any damage to the instrument please ensure you keep the original packaging. Ideally you should always keep the original packaging if the instrument must be returned for repair.

Safety Precaution before Operation

Check Power Supply

The analyzer is equipped with a three-wire power cord in accordance with international safety standards. The product must be grounded properly before being powered on, as floating or improper ground may cause damage to the instrument or personal injury.

Make sure the grounding conductor of the spectrum analyzer is grounded before turning on the instrument. After which the AC power cord can be connected. Do not use a non-ground power cord.

Allowed Variation Range of Supply Power Parameters

The spectrum analyzer is compatible with 100V~240V, 50Hz-60Hz AC power. The table below lists the power requirement to run the spectrum analyzer.

Power Supply Parameter	Compatible Range
Voltage	100 - 240 VAC
Frequency	50 - 60 Hz $\pm 10\%$
Power	22 W

To prevent or lower the risk of damage to the spectrum analyzer from power interference between instruments, especially from peak pulses produced by large power consumption instruments, a 220V/110V AC regulated power supply is recommended.

Power Cord Selection

The analyzer is equipped with a three-wire power cord in accordance with international safety standards. This cable grounds the analyzer cabinet when connected to an appropriate power line outlet. The cable must be rated greater than 250Vac and 2A.



WARNING

Improper grounding may cause damage to the instrument, or result in personal injury. Make sure the grounding conductor of the spectrum analyzer is grounded before turning on the instrument.

Always use a well-grounded power source. Do not use an external power cable, power cord or an auto transformer without grounded protection. If this product is to be powered via an external auto transformer for voltage reduction, ensure that its common terminal is connected to a neutral (earthed pole) of the power supply.

Make sure the supply power is stable before turning on the analyzer to protect it from damage. Refer to “First Time to Power on” on page 13

Electro-static Discharge (ESD) Protection

ESD is an issue often ignored by users. Damage from ESD on the instrument is unlikely to occur immediately but will significantly reduce the reliability of it. Therefore, ESD precautions should be implemented in the work environment, and applied daily.

Generally, there are two steps to manage ESD protection:

1. Conductive table mats to connect hands via wrist bands
2. Conductive ground mat to connect feet via ankle straps

Implement both protection methods will provide a good level of anti-static protection. If used alone, the protection will not be as reliable. To ensure user’s safety, anti-static components should offer at least $1M\Omega$ isolation resistance.



WARNING

The above ESD protections measures cannot be used when working with over 500V!

Make good use of anti-static technology to protect components from damage:

1. Quickly ground the internal and external conductor of the coaxial cable before it is connected with the spectrum analyzer.
2. Staff must wear anti-static gloves before touching the connector cord or doing any assemble work.
3. Assure all the instruments are grounded properly to avoid static storage.

First Time to Power on

Connect the three-pin AC power cord into the instrument. Insert the plug into a power socket provided with a protective ground.



WARNING

Check the power source before turning on the spectrum analyzer, to protect the device from damage.

Steps

1. Press the power switch  on the bottom left of the front panel.
2. Self-initialization takes about 30 seconds, after the boot screen the spectrum analyzer will default to the scanning curve.
3. After power on, let the spectrum analyzer warm up for 30 minutes for stabilization to obtain the most accurate results.

G E T T I N G S T A R T E D

This chapter introduces the front / rear panel, the user interface and explains how to use the instrument with a measurement example demonstration.

Package Contents and Accessories	15
Front Panel Overview	16
Rear Panel	18
Front Panel Function Key	20
Parameter Input.....	23
Numeric Keypad.....	23
User Interface	25
Build-in Help	27
Basic Measurement	27

Package Contents and Accessories

The GSP-818 has a number of standard and optional accessories that can be ordered. For more information please visit the GW Instek website at www.gwinstek.com or consult your authorized distributor for details.

Standard Accessories		Description
Power Cable		Mains power cable (region dependent)
CD ROM		Contains GSP-818 User manual, quick start guide, programming manual and USB driver

Optional Accessories	Part number	Description
	ADB-002	DC BLOCK BNC 50R 10 MHz-2.2 GHz
	ADB-006	DC BLOCK N TYPE 50R 10 MHz-6 GHz
	ADB-008	DC BLOCK SMA 50R 0.1 MHz-8 GHz

Front Panel Overview

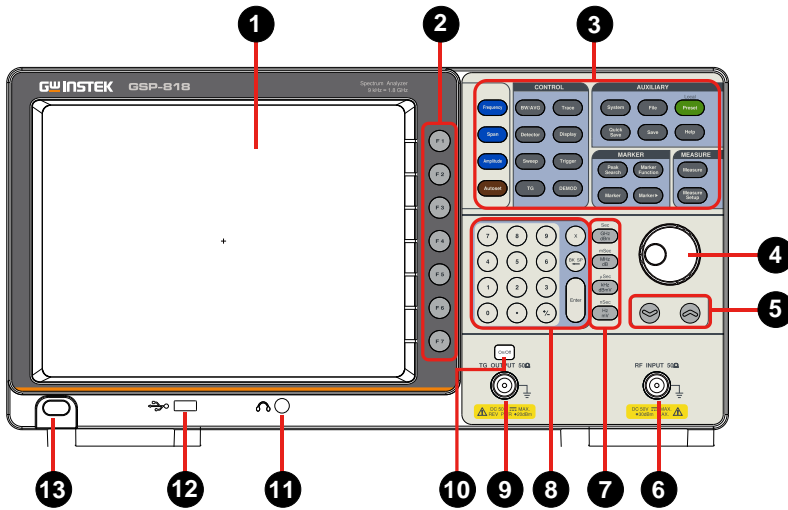

1. LCD 800x600 color LCD display. The display shows the soft keys for the current function, frequency, amplitude and marker information.

2. Menu soft keys

 The F1 to F7 function keys directly correspond to the soft keys on the right-hand side of display.

3. Function keys See page 20 for details.

4. Knob

 During parameter editing, turn the knob clockwise to increase, or counterclockwise to decrease the parameter values at specified steps.

5. Arrow keys

 (1) Increase or decrease the parameter value at specific steps while editing a parameter.
 (2) Move the cursor through the directory

tree in the **File** function

6. RF Input connector  The RF input may be connected to a device via a N type connector.



Note

When input attenuator is higher than 10 dB, the RF port input signal must be less than +30 dBm.



Input voltage at RF input port must not be higher than 50 V DC to avoid damage to the attenuator and input mixer tracking generator.

7. Unit keys  Unit keys include GHz/dBm/s, MHz/dB/ms, kHz/dBmV/μs and Hz/mV/ns. After entering the desired numbers, choose an appropriate unit to complete the input. The specific meaning of unit is decided by the type of input parameter ("frequency", "amplitude" or "time").

8. Numeric keypad See page 23 for details.

9. TG output connector  The output of the tracking generator can be connected to a receiver through an N type male connector, users can purchase this option if required.

10. TG output On/Off button  When the TG function is enabled, the backlight of button turns on and turns off when the function is disabled.





11. Earphone interface   3.5mm stereo headphone jack (wired for mono operation)

12. USB Host port  The analyzer may serve as a "host" device to connect to external USB devices. This interface is available for USB storage devices.

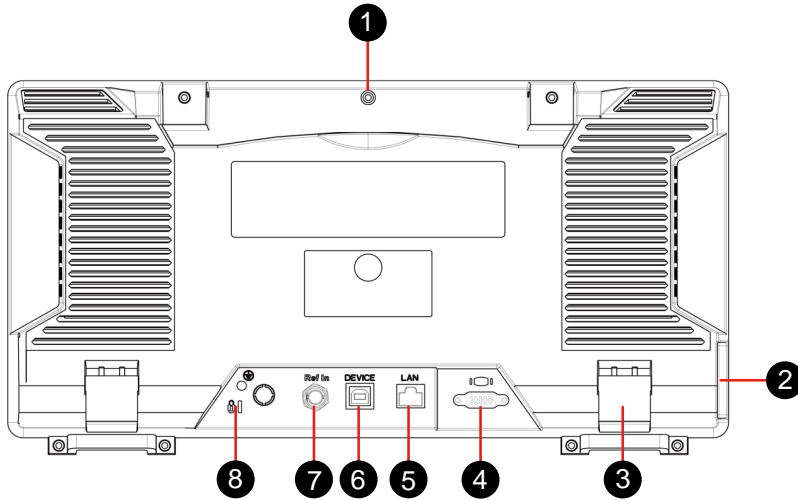
13. Power key  Push to turn on, long push to turn off

Rear Panel



- | | | |
|-------------------------|---|---|
| 1. Handle | | Stow the handle for mobile use. |
| 2. AC power connector | | AC: frequency 50Hz±10%, single-phase alternative 220V±15% or 110V±15% |
| 3. Stool | | To adjust the angle of the device |
| 4. VGA port |  | provides a VGA signal output which is used through a VGA cable or with a projector |
| 5. LAN interface |  | Through this interface, the analyzer can be connected to your local network for remote control. An integrated testing system can be built quickly, as the analyzer conforms to the LXI C Device class instrument standards. |
| 6. USB Device interface |  | This configurable USB port permits external USB devices. It supports PictBridge printer and remote-control connection. |
| 7. 10MHz IN/OUT |  | The BNC input or output of the 10 MHz reference clock |

8. Lock hole You can lock the spectrum analyzer to a fixed location using the security lock (please buy it yourself) to secure the spectrum analyzer.

Front Panel Function Key

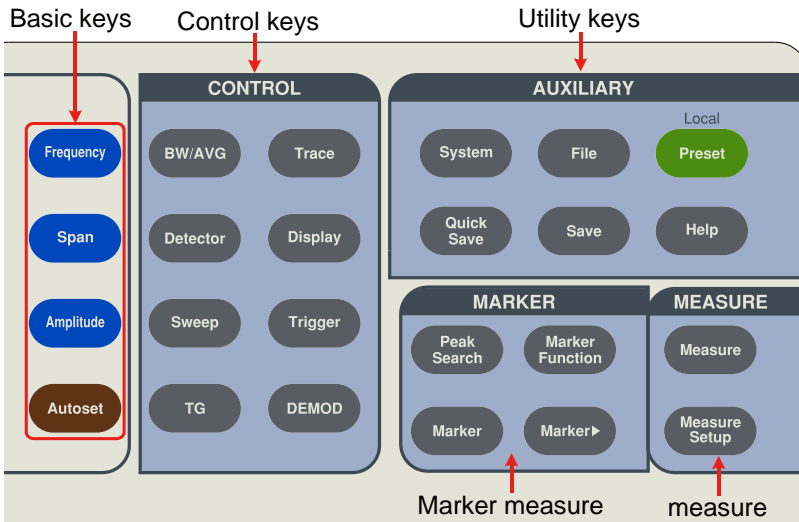

Keys	Description
Basic keys	
	Activates the center-frequency function, and accesses the frequency function menu.
	Activates the frequency sweep span function, and set Full Span\Zero Span\Last Span.
	Activates the reference level function, and accesses the amplitude softkeys, with which you set functions that affect data on the vertical axis.
	Searches the signal automatically within the full frequency range.

Control keys

- BW/AVG** Activates the RBW (resolution bandwidth) function, and accesses the softkeys that control the bandwidth functions and averaging.
- Trace** Accesses the softkeys that allow you to store and manipulate trace information.
- Detector** Accesses the softkeys that allow you to configure detector functions.
- Display** Accesses the softkeys that allow you to control what is displayed on the analyzer, including the display line, graticule and label.
- Sweep** Accesses the softkeys that allow you to set the sweep time, select the sweep mode of the analyzer.
- Trigger** Accesses the softkeys that allow you to select the trigger mode of the analyzer.
- TG** Accesses the softkeys that allow you to set the tracking generator.
- DEMOD** Accesses the softkeys that allow you to set the demodulation.

Marker measure keys

- Peak Search** Places a marker on the highest peak, and accesses the Peak functions menu.
- Marker** Accesses the marker control keys that select the type and number of markers and turns them on and off.
- Marker▶** Accesses the marker function soft keys that allow you to set other system parameters based on the current marker's value.
- Marker Function** Accesses the menu of special functions, such as noise marker, N dB bandwidth measure and frequency counting.

Advanced measure keys

Measure

Accesses the softkeys that let you make transmitter power measurements such as ACPR(adjacent channel power), channel power, and OBW(occupied bandwidth), etc.

Measure Setup

Sets the parameters for the selected measurement function.

Utility keys

System

Sets the system parameters, and accesses the calibration menu.

File

Accesses the softkeys that allow you to configure the file system of the analyzer.

Preset

Resets the analyzer to the factory settings or user state. This state can be specified in **【System】** → [PowerOn/Preset▶] →[Preset▶].

Quick Save

Save the contents of the current screen quickly.

Save

Accesses the soft keys that allow you to save current screen, trace data, or user state.

Help





Press the Help key to activate the help system. Press the Help key again to exit.

Parameter Input

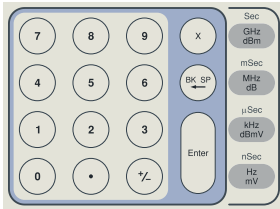
Specific parameter values are able to be entered using the numeric keypad, knob, and directional keys.

Numeric Keypad



- | | | |
|---------------|---|--|
| Numeric keys | | Numbers 0-9 are available to be used. |
| Decimal point |  | A decimal point "." will be inserted at the cursor position when this key is pressed. |
| Sign key |  | Sign key "+/-" is to toggle the sign of a parameter. When pressed the first time, a "-" will be inserted and changed into "+" following the second press. |
| Cancel key |  | <ol style="list-style-type: none"> (1) During the editing process this key will clear the inputs in the active area and exit editing mode at the same time. (2) Turn off the display in the active area. (3) Exit current test mode while in keyboard test. |
| Back key |  | <ol style="list-style-type: none"> (1) During the process of parameter editing, this key will delete the characters on the left side of the cursor. (2) While in the process of file name editing, pressing this key will delete characters that have been entered. |

Enter key



When pressed, the system will complete the input process and insert a default measurement unit for the parameter automatically.





Unit keys



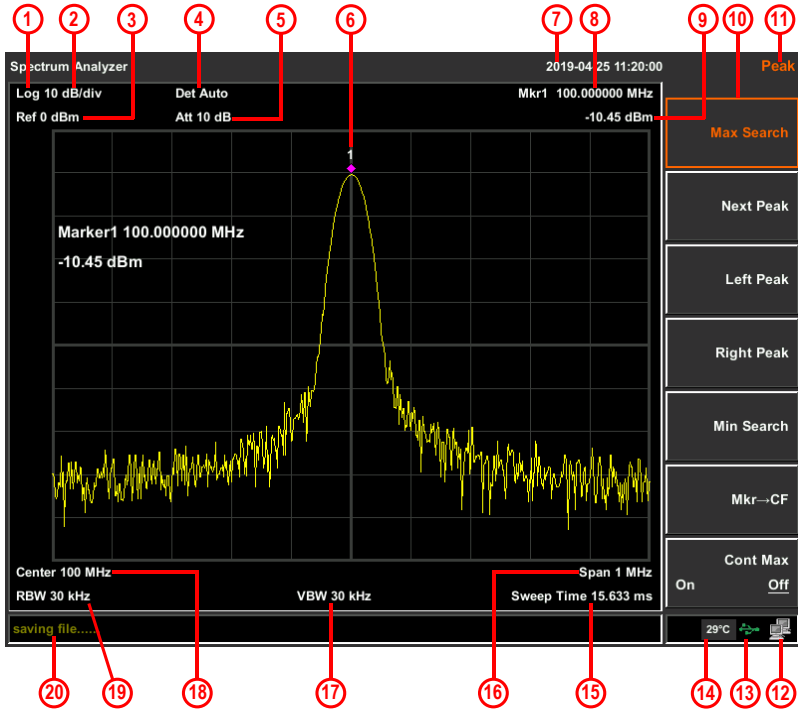







Unit keys include GHz/dBm/Sec, MHz/dB/mSec, kHz/dBmV/µSec and Hz/mV/nSec. After entering the desired numbers, choose an appropriate unit to complete the input. The specific meaning of unit is decided by the type of input parameter ("frequency", "amplitude" or "time").

User Interface



No.	Name	Description	Related Key
1.	Amplitude Division Type	Can choose logarithmic or linear	 → [Scale Type]
2.	Amplitude Division	Display division scale	 → [Scale/Div]
3.	Reference level	Reference level	 → [Ref Level]
4.	Detection type	Display detection type	
5.	Attenuation	Display input attenuation setting	 → [Attenuation]

6.	Marker	Display current activated marker	
7.	Date/time	Display system date and time	 → [Date/Time]
8.9.	Marker readout	Display frequency and amplitude of current marker	
10.	Menu item	Menu item of current function	
11.	Menu title	Function of current menu belongs to.	
12.	LAN access sign	LAN access sign	
13.	USB storage device	Show if USB storage device is inserted;	
14.	Temperature sign	Display device internal temperature	
15.	Sweep Time	System sweep time	 → [Sweep Time]
16.	Span	Display span width	 → [Span]
17.	Video bandwidth	Display video bandwidth	 → [VBW]
18.	Center frequency	Display center frequency	 → [Center Freq]
19.	Resolution bandwidth	Display resolution bandwidth	 → [RBW]
20.	System status	Display spectrum analyzer status	

Build-in Help

The built-in help provides information that refers to every function key and menu key on the front panel. Users can view this help information if required.

Basic Measurement

Basic measurements include, input signal frequency and amplitude display, marked by a frequency marker. Follow these four simple steps below to implement input signal measurement.

- | | |
|-------|---|
| Steps | <ol style="list-style-type: none"> 1. Setting center frequency 2. Setting span and resolution bandwidth 3. Activate marker 4. Setting amplitude |
|-------|---|

For example, to measure a 100MHz -20dBm signal, you must turn on the spectrum analyzer and ensure it is warmed up for 30 minutes to ensure measurement accuracy.

- | | |
|----------------------|--|
| Equipment connection | <ol style="list-style-type: none"> 1. Connect the output terminal of signal generator to the RF Input 50Ω terminal of spectrum analyzer. Set the parameters as follows: |
|----------------------|--|

Frequency	100 MHz
-----------	---------

Amplitude	-20 dBm
-----------	---------

- | | |
|--------------------|--|
| Setting parameters | <ol style="list-style-type: none"> 1. Press the Preset button to restore the analyzer to its factory defined state. The spectrum analyzer will display the spectrum from 9kHz to the maximum span width. The signal generated will display as a vertical line at 100MHz. |
|--------------------|--|

 A green oval button with the word "Preset" written in white text.

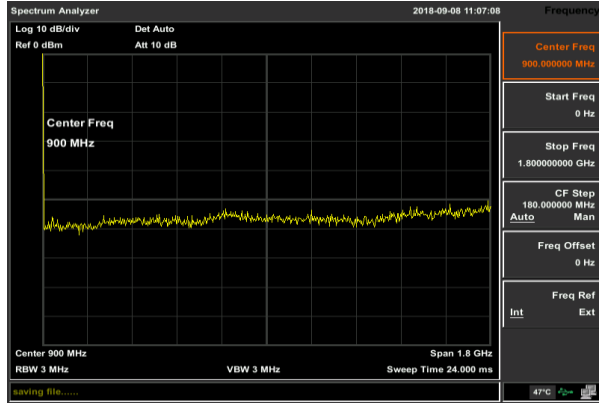

To clearly observe the signal, reduce the frequency span to 1 MHz and set the center frequency to 100MHz.

- Setting Center Frequency
Press the **FREQ** button and select **Center frequency** on corresponding pop up menu. Input "100" and select the unit as MHz on the numeric keypad. The keys can be used to set the exact value but the knob and directional keys can also be used to set the center frequency.



- Setting Frequency Span
Press the **SPAN** button, input "1" and select MHz as its unit using the numeric keypad or press ↓ button to decrease to 1MHz.



- Press the **BW** button and set **resolution bandwidth** to manual. Input 30 and select kHz as its unit using the numeric keypad or press ↓ button to decrease to 30kHz.

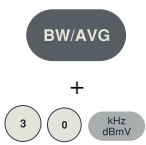

- Press the **Detector** button and set the detection type to positive peak.

Detector

The signal at a higher resolution

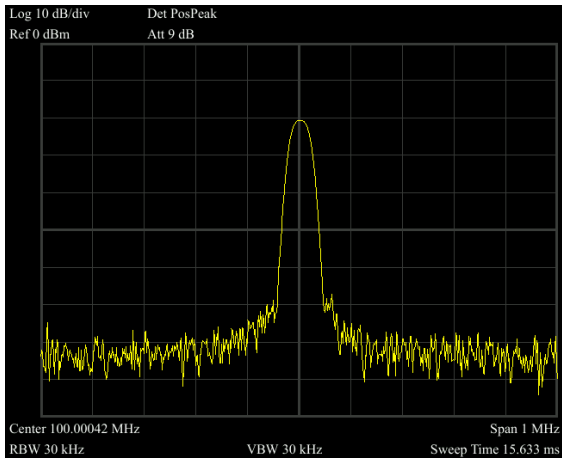

Please note that resolution bandwidth, video bandwidth and frequency span are self-adapted. They adjust to certain values according to frequency span. Sweep time can be self-adapted too.

Activate Marker

- Press the **Marker** button in the function area. Press the soft key to select Marker 1 2 3 4 5. Select Marker 1 and the marker is located at horizontal center by default. That is the signal peak point or its neighbor.
- Press **Peak** button and enter the next level menu. Select **Max Search**. Frequency and amplitude values are read by the marker and shown on the top right of the display area.

Marker

Peak Search

Setting amplitude 1. The reference level will be shown at the top of the display grid. To get a better dynamic range, the real signal peak point should be located at or near the top of display grid (reference level). The reference level is also the maximum value on Y axis. Here we reduce to 20dB reference level to increase the dynamic range.

2. Press the **AMPTD** button. The amplitude setting menu will pop up and the **reference level** soft key will be activated. The reference level can be input at the top left of the display grid. Input **-20** using the numeric keypad and set the unit to **dBm**. You can also use the ↓ key or the knob for adjustment.

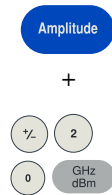

The reference level is set at -20dBm, which is the signal peak value near the top of the grid. The balance between the signal peak value and noise is dynamic range.

MENU INTEPRETATION

This chapter provides you with the information on using the front panel of the spectrum analyzer.

Frequency	35
Center Freq	35
Start Freq	36
Stop Freq	36
CF Step Auto Manual	37
Freq Offset	37
Freq Ref Internal External	38
Span	39
Span	39
Full Span	39
Zero Span	40
Last Span	40
Amplitude	41
Ref Level	41
Attenuation Auto Manual	42
Scale/Div	42
Scale Type Lin Log	43
Ref Offset	43
Ref Unit ▶	44
Preamplifier On Off	44
Auto Tune	45
Bandwidth/Average	46
RBW Auto Manual	46
RBW Mode Default Continuous	46
VBW Auto Manual	46
Average On Off	47
Trace	48
Trace 1 2 3 4 5	48
Clear Write	48

Max Hold.....	48
Min Hold.....	48
Blank.....	48
View.....	48
Operations▶.....	49
Detector.....	50
Detector type comparison.....	50
Auto.....	51
Normal.....	51
Pos Peak.....	51
Neg Peak.....	51
Sample.....	51
Display.....	52
Full Screen.....	52
Zoom On Off.....	52
Display Line On Off.....	52
Ampt Graticule On Off.....	52
Grid On Off.....	52
Style▶.....	52
Label On Off.....	53
Sweep.....	54
Sweep Time Auto Manual.....	54
Sweep Single.....	54
Sweep Cont.....	54
Sweep Points.....	54
Trigger.....	55
Auto Run.....	55
Video.....	55
Tracking Generator.....	56
Track Gen▶.....	56
Track Gen On Off.....	56
Output Level.....	56
Network Meas▶.....	56
Demodulation.....	58
DEMODO▶.....	58
Demod Mode▶.....	58
Sound.....	58
RadioSet▶.....	58
Digital Demod▶.....	58
AM▶.....	58

FM▶	59
Peak Search	60
Max Search	60
Next Peak.....	60
Left Peak	60
Right Peak.....	60
Min Search	61
Mkr→CF	61
Cont Max On Off.....	61
Marker	62
Marker 1 2 3 4 5	62
Trace 1 2 3 4 5	63
Normal	63
Delta	63
Off.....	64
All Off.....	65
Marker Table On Off.....	65
Marker→	66
Mkr->CF.....	66
Mkr->CF Step	66
Mkr->Start	66
Mkr->Stop.....	67
Mkr->Ref Level	67
MkrΔ->Span	67
MkrΔ->CF	67
Marker Function	68
Function Off.....	68
NdB On Off	68
Marker Noise On Off.....	68
Freq Count▶	68
Measurement	70
Measure off	70
Time Spec On Off	70
ACPR On Off	70
Chanel Power On Off.....	70
OBW On Off.....	71
Pass-Fail▶	71
Window Meas▶	71
Window Meas On Off.....	71
Amplitude Line On Off	71

Frequency Line On Off.....	71
Amplitude Upper limit Lower limit.....	71
Freq Start Stop	72
Window Scan On Off	72
Limit Meas▶	72
Limit Meas On Off.....	72
Line Up On Off.....	72
Line Low On Off.....	72
Shift X/Y Frequency Amplitude	72
UpLine Edit▶	73
Measure Setup.....	74
Channel BW.....	74
Channel Interval	74
Channel Numms	74
Power Percent	74
System	75
System▶	75
Config I/O▶	75
LAN▶	75
Power On/Preset▶	75
Language▶	76
Date/Time▶	76
Calibration▶	76
Service▶	77
File	78
Refresh.....	78
Type▶	78
First Page.....	78
Prev Page.....	78
Next Page	78
Last Page	78
Operations▶	78
Quick Save.....	79
Save.....	79
Screen Pixmap▶	79
Trace Data▶	79
User State.....	79

Frequency

Frequency

The frequency range of a channel can be expressed by either of two groups of parameters: Start Frequency and Stop Frequency; or Center Frequency and Span. If any such parameter is changed, the others would be adjusted automatically in order to ensure the coupling relationship among them

$$f_{center} = (f_{stop} + f_{start}) / 2$$

$$f_{span} = f_{stop} - f_{start}$$

f_{center} , f_{stop} , f_{start} and f_{span} denotes the center frequency, the stop frequency, the start frequency and the span respectively.

Center Freq

Sets the center frequency of the sweep. When pressed, the frequency mode is switched to Center Freq and Span in order to enter the desired parameter data.

Key Points

- The start and stop frequencies vary with the center frequency when the span is constant.
- Changing the center frequency horizontally shifts the current sweep channel and the adjustment is limited by the specified frequency range.
- In Zero Span mode, the start frequency, stop frequency and center frequency are always equal. If one is changed the others are updated to match.
- You can modify this parameter using the numeric keys, knob, or direction keys.

Start Freq

Sets the start frequency of the sweep. When pressed, the frequency mode is switched to Start Freq and Stop Freq in order to enter the desired parameter data.

Key Points

- The span and center frequency are changed automatically according to the start frequency. The change of the span would have influence on other system parameters. For more details, please refer to **Span**.
- In Zero Span mode, the start frequency, stop frequency and center frequency are always equal. If one is changed the others are updated to match.
- You can modify this parameter using the numeric keys, knob, or direction keys.
- If start freq is larger than stop freq when setting, then stop freq will increase automatically to the same value of start freq.

Stop Freq

Sets the stop frequency of the sweep. When pressed, the frequency mode is switched to Start Freq and Stop Freq in order to enter the desired parameter data.

Key Points

- Modifying the stop frequency changes the span and center frequency, and the change of span influences other system parameters, see **Span**.
- You can modify this parameter using the numeric keys, knob, or direction keys.
- If stop freq is larger than start freq when setting, then start freq will decrease automatically to the same value of stop freq.

CF Step Auto Manual

Sets the step of center frequency. Changing the center frequency in a fixed step continuously switches the channel to be measured.

Key Points

- The frequency step type could be “Manual” or “Auto”. In Auto mode, the CF step is 1/10 of span if it is in Non-zero span mode or equals 25% of RBW while in Zero span mode; in Manual mode, you can set the step using the numeric, step keys or knob. Then activate **Center Frequency**, press step, center frequency will change as setting step.
- After you set an appropriate frequency step and select center frequency, you can use using up and down direction keys to switch between measurement channels in a specified step in order to sweep the adjacent channels manually.
- You can modify this parameter using the numeric keys, knob, or direction keys.

Frequency step lends itself to detect the harmonic waves and bandwidths that are beyond the current span.

For example, for order of harmonic of a 300 MHz signal, you can use set both the center frequency and frequency step to 300 MHz, and press the up direction key continuously to increase the center frequency to 600MHz, that is secondary harmonic. Press frequency steps to increase center frequency by 300MHz, which reaches 900MHz. [Frequency Step Auto Manual] shows the auto or manual mode to setting the steps. When step is under manual mode, press [Frequency Step Auto Manual] to return to auto mode.

Freq Offset

You can set a frequency offset to displayed frequency value, including freq marker value. This movement won't influence sweep frequency range.

While this function activated (frequency offset isn't 0), you can modify this parameter using the numeric keys, knob or direction keys.

Freq Ref Internal External

Set the reference frequency as internal or external input, this is regarded as whole device reference.

Span

A blue rounded rectangular button with the word "Span" in white text.

Set the spectrum analyzer to span mode. When press the **SPAN** button, **Span**, **Full Span**, **Zero Span** and **Last Span** will be available to configure. You can modify span using the numeric keys, knob or direction keys. Use numeric key or **Zero Span** to clear span.

Span

Sets the frequency range of the sweep. When pressed, the frequency mode is switched to Center Freq/Span.

Key Points

- The start and stop frequencies are changed with the span automatically.
- In manual span mode, the span can be set down to 0 Hz, that is zero span mode. And up to the full span described in "Specification". When it is set to the maximum span, it enters full span mode.
- Modifying the span in non-zero span mode may cause an automatic change in both CF step and RBW if they were in Auto mode, and the change of RBW may influence VBW (in Auto VBW mode).
- In non-zero span mode, variation in the span, RBW or VBW would cause a change in sweep time.
- You can modify this parameter using the numeric keys, knob, or direction keys.

Full Span

Sets the spectrum analyzer to center frequency/sweep mode, and span of the analyzer to the maximum.

Zero Span

Sets the span of the analyzer to 0 Hz. Both the start and stop frequencies will equal the center frequency and the horizontal axis will denote time. The analyzer here is measuring the time domain characteristics of amplitude, located at the corresponding frequency point. This will help to observe the signal (especially for modulated signal) at time domain.

Last Span

Changes the span to the previous span setting.

Amplitude

Amplitude

Sets the amplitude parameters of the analyzer. Through these parameters, signals under measurement can be displayed at an optimal view with minimum error. The pop out amplitude menu includes **Ref Level**, **Attenuation Auto Manual**, **Scale/Div**, **Scale Type Lin Log**, **Ref Offset**, **Ref Unit** and **Preamplifier On Off**.

Ref Level

Activate reference level function and sets the maximum power or voltage for display window.

Key Points

- This value is affected by a combination of maximum mixing level, input attenuation, and preamplifier. When you adjust it, the input attenuation is adjusted under a constant max mixing level, meeting:

$$L_{Ref} - a_{RF} + a_{PA} \leq L_{mix}$$

L_{Ref} , a_{RF} , a_{PA} and L_{mix} denotes the reference level, the input attenuation, the preamplifier, and the max mixing level, respectively.

- You can modify this parameter using the numeric keys, knob, or direction keys.

Reference level located at the top of axis grid. Measurement near the reference level would gain better accuracy, but input signal amplitude should not exceed the reference level; if it exceeds, the signal will be compressed and distorted, result in wrong measurement. Analyzer's input attenuation is related with reference level, it can self-adjust to avoid signal compression. Minimum reference level is -80dBm at Log scale under 0dB attenuation.

Attenuation Auto Manual

Sets the front attenuator of the RF input in order to permit big signals (or small signals) to pass from the mixer with low distortion (or low noise). It only works under internal mixer mode to adjust input attenuator insider analyzer. In Auto mode, input attenuator is related with reference level.

Key Points

- When the preamplifier is On, the input attenuation could be set up to 39 dB. You can adjust the reference level to ensure that the specified parameters meet the requirement.
- Modifying the reference level may cause an automatic change in attenuation value; But the change of attenuation value won't influence reference level.
- You can modify this parameter using the numeric keys, knob, or direction keys.

Attenuator adjustment is to make the maximum signal amplitude pass from mixer less than or equal to -10dBm. E.g. if the reference level is +12dBm, the attenuator value is 22dB, then the input level in mixer is -18dBm ($12-22-8=-18$), its mainly purpose is to avoid signal compression. Switch **Input Atten Auto Manual** to manual mode, adjust the attenuator manually. The highlight under auto or manual stands for auto coupling and manual coupling. When attenuator is under manual mode, press **Input Atten Auto Manual** will match the attenuator and reference level again.



Note

Maximum input signal amplitude of input attenuator (10dB input attenuation at least) is +27dBm, higher power signal will damage input attenuator or mixer.

Scale/Div

Sets the logarithmic units per vertical grid division on the display. Select 1,2,4 or 10dB log amplitude scale. It's 10dB/div by default. Every activated marker is with dB as unit, difference between two markers is treated as marker difference under dB unit.

- Key Points
- By changing the scale, the displayed amplitude range is adjusted.
 - The amplitude that can be displayed is from reference level minus 10 times the current scale value to the reference level.
 - You can modify this parameter using the numeric keys, knob, or direction keys.

Scale Type Lin Log

Sets the Scale Type of Y-axis to Lin or Log, the default is Log. It only works under internal mixer mode. In general, select mV as Lin amplitude scale unit. Of course there would be other units for select.

- Key Points
- In Log scale type: the Y-axis denotes the logarithmic coordinates, the value shown at top of the grid is the reference level and the grid size is equal to the scale value. The unit of Y-axis will be automatically switched into the default "dBm" when the scale type is changed from Lin to Log.

In Lin scale type: the Y-axis denotes the linear coordinates, the value shown at the top of the grid is the reference level and the bottom of the grid shows 0 V. The grid size is 10% of the Reference level and the Scale/Div is invalid. The unit of Y-axis will be automatically switched into the default "mV" when the scale type is changed from Log to Lin.

Other than as mentioned above, the unit of Y-axis is independent of the Scale Type.

Ref Offset

Assigns an offset to the reference level to attempt to compensate for gains or losses generated between the device under measurement and the analyzer.

Key Points

- The changing of this value changes both the readout of the reference level and the amplitude readout of the marker, but will not impact the position of the curve on the screen.
- You can modify this parameter using the numeric keys.
- This offset use dB as absolute unit, will not change with selected scale and unit.

Ref Unit ►

Sets the unit of the Y-axis to **dBm**, **dBmV**, **dBuV**, **V** or **W**.

dBm	Choose decibel equals to 1mW as amplitude unit.
dB μ W	Choose decibel equals to 1 μ W as amplitude unit.
dBpW	Choose decibel equals to 1pW as amplitude unit.
dBmV	Choose decibel equals to 1mV as amplitude unit.
dB μ V	Choose decibel equals to 1 μ V as amplitude unit.
W	Choose Watts as amplitude unit.
V	Choose Voltage as amplitude unit.

Preamplifier On Off

Sets the status of preamplifier located at the front of the RF signal path. Turning on the preamplifier reduces the displayed average noise level in order to distinguish small signals from the noise when working with small signals.

Auto Tune

Autoset

Searches for signals automatically throughout the full frequency range, adjusts the frequency and amplitude to their optimum and realizes one-key signal search and auto setting of parameters.

Key Points

- Some parameters such as reference level, scale, and input attenuation may be changed during the auto tune.

Bandwidth/Average

BW/AVG

Sets the RBW (Resolution Bandwidth) and VBW (Video Bandwidth) parameters of the analyzer. Pop out the setting menu includes **RBW Auto Manual**, **RBW Mode Default Continuous**, **VBW Auto Manual**, **Average On Off** and **EMI BW▶**.

RBW Auto Manual

Adjust the resolution bandwidth ranging from 10Hz-3MHz. Use numeric key, step key or knob to switch resolution bandwidth. The underline under Auto or Manual means Auto mode or Manual mode. Press [Resolution Bandwidth Auto Manual] and hold it until underline under Auto has been highlighted. Then the resolution bandwidth is under auto coupling mode.

Key Points

- Reducing the value of RBW will increase the frequency resolution, but may also cause sweeps to take longer (Sweep Time is effected by a combination of RBW and VBW when it is in Auto mode).
- RBW decreases with the span (non-zero span) in Auto RBW mode.

RBW Mode Default Continuous

Adjust resolution step mode, resolution mode can be set to 1-3-5, Default or Continuous mode.

VBW Auto Manual

Sets the desired video bandwidth in order to remove the band noise. Set the video resolution displays in function area, ranging from 10Hz to 30MHz by sequence step. You can modify this parameter by numeric key, step key or knob. The underline under Auto or Manual means Auto mode or Manual mode. Press [VBW Auto Manual] and hold it in manual until the underline highlighted under Auto to return auto mode.

- Key Points
- Reducing the value of RBW will increase the frequency resolution, but may also cause sweeps to take longer (Sweep Time is effected by a combination of RBW and VBW when it is in Auto mode).
 - VBW varies with RBW when it is set to Auto.

Average On Off

Trace average function. It doesn't need narrow VBW to implement smooth trace. This function set the wave detector to acquisition mode, continuously get average of the trace to smooth it.

EMI BW▶ (Only apply to - Opt. 02 EMI Settings)

Pop out the menu for EMI measurement bandwidth.

EMI bandwidth On Off	Turn on or off EMI measurement resolution bandwidth.
1MHz	Set EMI measurement resolution to 1MHz.
120kHz	Set EMI measurement resolution to 120kHz.
9kHz	Set EMI measurement resolution to 9kHz.
200Hz	Set EMI measurement resolution to 200Hz.

Trace

A dark grey rounded rectangular button with the word "Trace" in white text.

As the sweep signal is displayed as a trace on the screen, you can set parameters about the trace using this key. The analyzer allows for up to five traces to be displayed at one time, and press this key to check the menu for trace. It includes **Trace 1 2 3 4 5**, **Clear Write**, **Max Hold**, **Min Hold**, **Blank**, **Check**, [1 ↔ 2], [2 - DL → 2], [2 ↔ 3], [1 → 3] and [2 → 3].

Trace 1 2 3 4 5

Select trace, the analyzer offers 1,2,3,4,5 trace. The selected trace and corresponding status menu will be underlined.

Clear Write

Refresh current curve and display the analyzer trace.

Max Hold

Maintains the maximum for each point of the trace. It continuously receive scan data and select positive peak value detect mode.

Min Hold

Maintains the minimum for each point of the trace. It continuously receive scan data and select negative peak value detect mode.

Blank

Clear the trace on screen. But the trace stock will keep still without refreshing.

View

Stops updating trace data and display current trace for observation..

Operations ►

Enter trace math related sub menu.

1 ↔ 2	Exchange the trace stock 1 data with trace stock 2 and place them in display mode.
2-DL → 2	Deduct display line value in trace stock 2. This function execute once when activated. Press 2 - DL → 2 again to execute it the second time. When this function activated, display line will also be activated.
2 ↔ 3	Exchange the trace stock 2 data with trace stock 3 and place them in display mode.
1 → 3	Exchange the trace stock 1 data with trace stock 3 and place them in display mode.
2 → 3	Exchange the trace stock 2 data with trace stock 3 and place them in display mode.

Detector



While displaying a wider span, each pixel contains spectrum information associated with a larger subrange. That is, several samples may fall on one pixel. Which of the samples will be represented by the pixel depends on the selected detector type. Press this key to pop out the relevant menu includes **Auto**, **Normal**, **Pos Peak**, **Neg Peak** and **Sample**.

Key Points

- Selects an appropriate type according to the application in order to ensure the accuracy of the measurement for your application.
- The available types are: Pos Peak, Neg Peak, Sample.
- Every selected type is shown with a parameter icon on the left status bar of screen.

Detector type comparison

Detector Type	Measurement
Auto	Normal wave detect is the most common way to detect waveform. It can observe the signal and base noise at the same time without losing any signal.
Normal	Display pos peak and neg peak alternately when noise is detected, or it only display pos peak.
Pos Peak	Positive peak detection ensures that no peak signal is missed, which is useful for measuring signals that are very close to the base noise.
Neg Peak	Negative peak detection is used in most cases with the self-test of the spectrum analyzer and is rarely used in the measurement. It is able to restore the modulation envelope of the AM signal well.

Sample Sampling detector is conducive to measurement noise signal. Compared with the standard detection method, it can measure noise better.

Auto

Set the detector to auto detection mode (default mode). In this mode, when the span is greater than 1MHz, the detection method is set as Normal. When the span is less than or equal to 1MHz, the detection method is set as Positive Peak.

Normal

When noise is detected, the positive and negative peaks are alternately displayed, otherwise only positive peaks are displayed.

Pos Peak

Searches the maximum from the sampling data segment and displays it at the corresponding pixel. Positive peak detector will be selected when [Max Hold] pressed.

Neg Peak

Searches the minimum from the sampling data segment and displays it at the corresponding pixel.

Sample

Set the detector to the sampling detector mode. This mode is usually used for video averaging and noise frequency Maker.

Display

Display

Controls the screen display of the analyzer, such as setting the on or off for window zoom, display line, amplitude scale, grid, label, and display style.

Full Screen

Set to full-screen display graphical interface, press any key to exit.

Zoom On Off

In multi-window display mode, press this button to zoom in on the selected window. Press the key for the first time to enlarge the selected window to the entire graphic display area. Press this button again to exit the entire graphic display area and restore the multi-window display mode.

Display Line On Off

When this menu is on, an adjustable horizontal reference line is activated on the screen.

Ampt Graticule On Off

Turn on or Off amplitude scale function.

Grid On Off

It's the grid lines displaying and hiding menu. When the grid display line is on, pressing [Grid On Off] again will turn it off.

Style▶

Set the spectrum analyzer display style as default or WinXP.

Label On Off

Defines the content displayed or hidden in the comments that appear in the display grid area.

Sweep

Sweep

Sets parameters about the Sweep time and mode including **Sweep Time Auto Manual**, **Sweep Single** and **Sweep Cont**.

Sweep Time Auto Manual

Sets the time interval for the analyzer to complete a sweep.

In non-zero span, the analyzer uses the shortest sweep time on the basis of the current RBW and VBW settings if Auto is selected.

You can modify this parameter using the numeric keys, knob, or direction keys.

Sweep Single

Press **Single Sweep** to set the sweep mode to Single. Press **Single Scan** to restart the scan when the next trigger signal arrives. Allows you to set continuous scan mode.

Sweep Cont

Press **Continuous Scan** to activate the sweep scan mode.

Sweep Points

Sets the desired points for every sweep. That is the number of points of the current trace.

Key Points

- Changing the points may influence the sweep time which is limited by the sample rate of the ADC (Analog to Digital Converter). That is, the more points used, the longer the sweep will be.
- Changing the points would also influence other system parameters, thus the instrument restarts the sweep and measurement cycle.
- You can modify this parameter using the numeric keys, knob or direction keys.

Trigger

Trigger

Sets the trigger type and other associated parameters, menu includes **Auto Run** and **Video**.

Auto Run

Set the trigger mode to the free trigger mode so that the scan trigger is as fast as possible with the spectrum analyzer. It meets the trigger conditions at any time, that is, continue to generate a trigger signal.

Video

This indicates a trigger signal will be generated when the system detects a video signal in which the voltage exceeds the specified video trigger level.

Tracking Generator

TG

When the Tracking Generator is On, a signal with the same frequency of the current sweep signal will be output from the GEN OUTPUT 50Ω terminal on the front panel. Press the key will pop out related menu includes **Track Gen▶**, **Track Gen On Off**, **Output Power** and **Network Measure▶**. The tracking source is turned off in the power-on and reset states.

Track Gen▶

To configure tracking source.

Track Gen On Off

RF output and spectrum reception are fully synchronized on the frequency sweep, and the tracking source frequency can not be set individually.

Output Level

Tracking Source power output range from 0dBm to -30dBm.

Network Meas▶

Tracking source network measurement function, mainly for amplitude and frequency characteristics measurement; RF output and spectrum measurement is fully synchronized, can be used as a scalar network analyzer. When the network measurement function is **on**, the measurement results show relative values after **normalized**, expressed in **dB**. When the network measurement function is **off**, the measurement shows the spectrum measurement result, expressed in **dBm**.

Network Meas On <u>Off</u>	Turn on or off the tracking source network measurement function. Tracking source network measurement function, mainly for amplitude and frequency characteristics measurement; RF output and spectrum measurement is fully synchronized, can be used as a scalar network analyzer. When the network measurement function is on , the measurement results show relative values after normalized , expressed in dB . When the network measurement function is off , the measurement shows the spectrum measurement result, expressed in dBm .
Output Level	Used to set the output power of the trace source..
Ref Level	This soft menu is used to track the source network measurement of the user to adjust the measurement results display location.
Sweep Points	Used to set the number of scanning points for network measurements.
Sweep Time	Used to set the scan time for network measurements.
Normalize	This soft menu is used to track the user's field calibration of the source network measurements. After connecting the instrument's RF output to the RF input, press the normalized soft menu and the display shows a straight line on the 0dB scale.

Demodulation

DEMOD

Enter the demodulation settings, the spectrum analyzer supports audio demodulation and AM, FM digital demodulation.

DEMOD ▶

Enter Audio Demod soft menu.

Demod On Off Turn audio demodulation on or off.

Demod Mode ▶

Enter the demodulation mode soft menu. Including FMW, FM, AM, USB, LSB.

Sound

When the audio demodulation is on, adjust the speaker output volume.

RadioSet ▶

Quick access to the common broadcast band.

Digital Demod ▶

Enter the digital demodulation soft menu.

AM ▶

Enter AM demodulation soft menu.

AM On Off Turn AM demodulation On or Off.

Carrier Freq Set the carrier frequency of the AM modulation signal.

IF BW Auto Manual	Set the demodulation bandwidth to auto or manual mode.
----------------------	--

FM ►

Enter FM demodulation soft menu.

FM On Off	Turn FM demodulation On or Off.
-----------	---------------------------------

Carrier Freq	Set the carrier frequency of the FM modulation signal.
--------------	--

IF BW Auto Manual	Set the demodulation bandwidth to auto or manual mode.
----------------------	--

Peak Search

A dark grey rounded rectangular button with the text "Peak Search" in white.

Executes peak searching immediately and opens the Peak setting menu.

Key Points

- If Max is selected from the Peak Search option, it will search and mark the maximum on the trace.
- The peak search of Next Peak, Peak Right, Peak Left or peaks in the peak table must meet the specified parameter condition.
- The spurious signal at the zero frequency caused by LO feed through is ignored.

Max Search

Place a frequency scale at the highest point of the trace and display the frequency and amplitude of the frequency scale in the upper right corner of the screen. **Max search** does not change the activated function.

Next Peak

Searches the peak whose amplitude is the closest to that of the current peak. The peak is then identified with a marker. When this key is pressed repeatedly, you can quickly find a lower peak.

Left Peak

Searches the nearest peak located to the left side of the current peak and meets the current peak and peak thresholds condition. The peak is then identified with a marker.

Right Peak

Searches the nearest peak located to the right side of the current peak and meets the current peak and peak thresholds condition. The peak is then identified with a marker.

Min Search

Searches the peak with the minimum amplitude on the trace and identifies it with a marker.

Mkr→CF

Used to move the peak point to the center frequency point.

Cont Max On Off

Set the peak search form, off by default. On mode will automatically search for the peak.

Marker



The marker appears as a rhombic sign (shown below) for identifying the point on the trace. We can easily readout the parameters of the marked point on the trace, such as the amplitude, frequency and sweep time.

Key Points

- The analyzer allows for up to three groups of markers to be displayed at one time, but only one pair or one single marker is active every time.
- You can use the numeric keys, knob or direction keys to enter the desired frequency or time when any marker type menu is active, so as to view the readouts of different points on the trace.

Marker 1 2 3 4 5

Selects one marker, the default is Marker1. And place the frequency scale at the center of the trace. If the frequency difference is activated, this soft key changes to the menu under the **Difference** function.

If there is already a marker, this command will not produce any operation. If there are already two markers (e.g. in **Difference** mode), **Marker** changes the active frequency scale to a new single frequency scale. Amplitude and frequency information can be obtained from the frequency scale (time information when the sweep width is 0Hz), and these values are displayed in the upper right corner of the active function area and the screen. You can use the numeric keys, the step key, or the knob to move the active frequency scale.

The marker reads data from the current active track (this track may be track A or track B). If both tracks are active or both tracks are in static display mode, the frequency scale will read data from track A.

Trace 1 2 3 4 5

In the trace measurement, the frequency scale used to activate the traces.

Normal

One of the marker types, which is used to measure the values of X (Frequency or Time) or Y (Amplitude) at certain point of the trace. When selected, a marker will appear with its own digital ID such as "1" on the trace.

Key Points

- If no active marker exists currently, a one will be enabled automatically at the center frequency of current trace.
- You can use the knob, direction keys or numeric keys to move the marker. The readouts of the marker will be displayed on the upper right of the screen.
- The readout resolution of the X-axis corresponds to the span and sweep points. For higher resolution, add sweep points or reduce the span.

Delta

One of the marker types, which is used to measure the delta values of X (Frequency or Time) and Y (Amplitude) between the Reference point and certain point on the trace. When selected, a pair of markers appears on the trace, which are the Reference Marker and the Delta Marker. Will be in the active area and the display area of the upper right corner, showing the amplitude delta value between the two markers and frequency difference. If a single marker already exists, [Delta] will place a static marker and an active marker to the original position and a single marker position. Use the knob, step key, or number keys to move the marker. If there are two markers, press [Delta] directly. However, if [Delta] has been

activated, press **Delta** to place the still frequency scale to the active marker. The displayed amplitude difference is expressed in dB, or is the linear unit in terms of the corresponding scale.

Key Points

- The Reference Marker will be activated at the position of current marker, or else both the reference marker and Delta Marker will be simultaneously activated at the center frequency location if no marker is active at the present.
- The location of the Reference Marker is always fixed (both in the X-axis and the Y-axis), while the Delta Marker is active. You can use the numeric keys, knob or direction keys to change the location of Delta Marker.
- The delta of both the Frequency/Time and the amplitude between the two markers are displayed at the upper right of the screen.

Two ways to enable a certain point as the reference:

Key Points

- Open a **Normal** marker and locate it onto a point and then switch the marker type into "Delta", creating a new reference, then you can modify the location of the delta point to achieve the delta measurement.
- Open a Delta Marker and place it onto a point, then reselect the Delta menu to locate the marker you opened onto this points, then you can modify the location of the delta point to achieve the delta measurement.

Off

The marker information displayed on the screen and functions based on the marker will be turned off and won't show up again.

All Off

Turns off all the opened markers and the related functions. The marker won't show again.

Marker Table On Off

Turns on or off the display of all marker table.

Marker→

A dark grey rounded rectangular button with the word "Marker" in white text and a white right-pointing arrow.

A soft menu associated with the marker function is popped out for setting the other system parameters (such as Center frequency, Reference level) by current marker readings. These menus relate to the frequency of the spectrum analyzer, whether the sweep width and marker are in normal or delta marker mode.

Mkr->CF

Sets the center frequency of the analyzer based on the frequency of the current marker. This feature quickly moves the signal to the center of the screen.

If Normal is selected, the center frequency will be set to the frequency of the current marker.

If Delta Marker is selected, the center frequency will be set to the frequency at which the Delta Marker is located.

The function is invalid in Zero span mode.

Mkr->CF Step

Sets the center frequency step of the analyzer based on the frequency of the current marker.

If Normal is selected, the center frequency step will be set to the frequency of current marker.

If Delta Marker is selected, the center frequency step will be set to the frequency at which the Delta Marker is located.

The function is invalid in Zero span mode.

Mkr->Start

Sets the start frequency of the analyzer based on the frequency of the current marker.

If Normal is selected, the start frequency will be set to the frequency of the current marker.

If Delta Marker is selected, the start frequency will be set to the frequency at which the Delta Marker is located.

The function is invalid in Zero span mode.

Mkr->Stop

Sets the stop frequency of the analyzer based on the frequency of the current marker.

If Normal is selected, the stop frequency will be set to the frequency of the current marker.

If Delta Marker is selected, the stop frequency will be set to the frequency at which the Delta Marker is located.

The function is invalid in Zero span mode.

Mkr->Ref Level

Sets the reference level of the analyzer based on the amplitude of the current marker.

If Normal is selected, the reference level will be set to the amplitude of the current marker.

If Delta Marker is selected, the reference level will be set to the amplitude at which the Delta Marker is located.

Mkr Δ ->Span

Changes the span of the analyzer to the frequency difference between the two markers.

Mkr Δ ->CF

Changes the center frequency of the analyzer to the frequency difference between the two markers.

Marker Function

Marker
Function

Executes specific marker soft menu.

Function Off

Turn off marker measurement function.

NdB On Off

Enables the N dB BW measurement or sets the value of N. The N dB BW denotes the frequency difference between points that are located on both sides of the current marker while the amplitude falls off ($N < 0$) or rises ($N > 0$) N dB separately,

Key Points

- When the measurement starts, the analyzer will search the two points which are located at both sides of the current point and are N dB amplitudes smaller or greater than the current point, and display the frequency difference between the two points.
- You can use the numeric keys, knob or direction keys to modify the value of N, 3 at default.

Marker Noise On Off

Turn on or off the frequency noise function. The function of marking noise is applied to the selected cursor, and then the noise Power Spectral Density at the cursor is read. When turned on, the average noise level read at the frequency scale is normalized to 1 Hz bandwidth for noise power.

Freq Count ►

Activate the frequency counter function and display the count results in the upper right corner of the screen. The counter counts only the signals that are displayed on the screen. The frequency

count also pops up an additional counter function for the soft menu, including **Freq Count On Off**

Freq On Off	Turn on or off the frequency counter mode. This function is invalid when the trace signal generator is activated. The count value is displayed in the upper right corner of the screen.
Resolution	Counter resolution is divided into 1 kHz, 100 Hz, 10 Hz, 1Hz. Changing the counter resolution can change the counter accuracy. The higher the resolution, the higher the counting accuracy.

Measurement

A dark grey rounded rectangular button with the word "Measure" in white text.

Provide a variety of advanced measurement functions, pop-up spectrum analyzer built-in and user-defined measurement function soft menu, turn on or off the time spectrum, adjacent channel power measurement, channel power measurement, occupied bandwidth, Pass-Fail measurement menu.

Measure off

You can directly close the currently running measurement function, you can also choose to close the measurement menu.

Time Spec On Off

Turn on time spectrum measure mode.

ACPR On Off

Turn on or off the adjacent channel power measurement. the **Meas Setup** button to pop up the parameters of the adjacent channel power measurement soft menu. The adjacent channel power is used to measure the ratio of the adjacent channel power of the transmitter. The absolute value of the main channel power and the absolute value of the adjacent channel power are obtained by the linear power integration method, so that the adjacent channel power ratio is gained.

Chanel Power On Off

Turn on or off channel power measurements. Press the **Meas Setup** button to pop up the channel power measurement parameter settings soft menu. The channel power is used to measure the transmitter channel power, according to the user set the channel bandwidth, through the linear power integration method to obtain the absolute value of the main channel power.

OBW On Off

Turn on or off the occupied bandwidth measurement. Press the **Meas Setup** button to pop up the parameter setting soft menu for occupying the bandwidth measurement. Occupied Bandwidth is a measure of the bandwidth occupied by the transmitter signal can be measured from the total power ratio within the in-band power span, with a default value of 99% (the user can set this value).

Pass-Fail ►

Enter the pass / fail measurement function soft menu. Pass/ fail measurement has two modes of window measurement and area measurement.

Window Meas ►

Enter Window measurement soft menu.

Window Meas On Off

Turn on or off window measurement mode.

Amplitude Line On Off

Turns the amplitude line on or off, and the amplitude line turns on when the window measurement is on.

Frequency Line On Off

Turns the frequency line on or off, and the frequency line turns on when the window measurement is on.

Amplitude Upper limit Lower limit

Used to edit the upper and lower limit on the amplitude line.

Freq Start Stop

Start and stop frequencies for scanning line for editing.

Window Scan On Off

Turn window scan on or off. When the window scan is on, only the window formed by the intersection of the amplitude line and the frequency line is scanned. The peripheral stops scanning; the full frequency is scanned when it is closed.

Limit Meas▶

Enter the soft menu of the area measurement mode.

Limit Meas On Off

Turn On or Off area measurement mode.

Line Up On Off

When the upper limit line is turned on or off, the upper limit line is opened by default when the area measurement is on.

Line Low On Off

When the lower limit line is turned on or off, the lower limit line is opened by default when the area measurement is on.

Shift X/Y Frequency Amplitude

Frequency	For the actual measurement, the edited area as a whole superimposed on a frequency, so that it can implement left or right shift, easy to measure. Does not affect the frequency and marker of the spectrum analyzer settings.
-----------	--

Amplitude The region has been edited on the whole superimposed on a degree, so that it can move up or down, easy to measure. Does not affect the amplitude setting of the spectrum analyzer.

UpLine Edit ▶

Upper line editing is used to edit the control line above the trace, depending on the trace.

LowLine Edit ▶

Lower line editing is used to edit the control line above the trace, depending on the trace.

Measure Setup

A dark grey rounded rectangle containing the text "Measure Setup" in white.

Measurement setting menu for the corresponding measurement parameter settings when adjacent channel power, channel power, occupied bandwidth measurement mode is turned on.

Channel BW

Set the bandwidth of the channel power measurement, and set the total display power percentage of bandwidth.

Channel Interval

Set the center frequency difference of the primary channel to the adjacent channel.

Channel Num

Set the number of upper and lower adjacent channels measured by adjacent channel power.

Power Percent

Set the power ratio of occupied bandwidth.

System



A soft menu for system parameter settings pops up. Including **System Info ▶**, **Configure I/O ▶**, **Power On/Reset ▶**, **Local Language ▶**, **Date/Time ▶**, **User Calibration ▶**, **System Service ▶**. For first time you use the spectrum analyzer, set the date and time, the system will store the settings, restart the machine after power off won't change the settings.

System▶

Pop up system information and system log soft menu.

Config I/O▶

A soft menu for setting the interface address of the spectrum analyzer, including **Network ▶**. The spectrum analyzer supports VGA, LAN and USB interface communication.

LAN▶

Pop out the relative menu for network configuring.

IP	Used to set the IP address of the LAN port.
Mask	Set the subnet mask parameter.
Gate	Set default gateway address.
Reset Lan	To reset the LAN.

Power On/Presets▶

Used to set the analyzer power on parameters or reset parameters.

Power Set▶	Power on parameter settings include Factory and User
------------	--

Preset▶ Power on parameter settings include **Factory** and **User**



Note

To save the current system configuration as a user-defined configuration, press the [Save] panel key and select the [User Status] menu item.

Language▶

To set the system language, in Chinese by default.

Date/Time▶

Used to set the device date, time, and their format.

Date/Time On Off Turn on or off Date/Time display.

Format▶ Time format can be displayed as **Year,Month,Day,Hour,Minute,Second** or **Hour,Minute,Second,Year,Month,Day**.

Date Set Set the display date for spectrum analyzer. Format is YYYYMMDD. E.g. June 22th, 2012 should display as 20120622.

Time Set Set the display time for spectrum analyzer. Format is HHMMSS. E.g. 16:55:30 should display as 165530.

Calibration▶

Pop up user calibration soft menu including **Start Calibration** and **Restore Factory**.

Calibration Set the signal generator frequency as 440MHz, power as -20dBm, access to RF instrument RF input, press the [Start Calibration] softkey, start the implementation of user calibration.

Factory	If you do not need the user calibration compensation data, press the [Restore Factory] key to clear the data and return to the factory status.
---------	--

Service ►

For spectrum analyzer debugging.

File

File

Pop up file management soft menu.

Refresh

In the directory state, view the latest stored files.

Type▶

To check file type under directory, includes screen image, trace data and display all.

First Page

Display first page of current directory.

Prev Page

Display Previous page.

Next Page

Display next page.

Last Page

Display last page of current directory.

Operations▶

Pop out the soft menu for file operation, includes sorting order, delete, export and import.

Quick Save

A dark grey rounded rectangular button with the text "Quick Save" in white.

Save the contents of the current screen quickly.

Save

A dark grey rounded rectangular button with the text "Save" in white.

It's available to save screenshot, trace data, or user status.

Screen Pixmap▶

Enter screenshot save soft menu, you can choose to save screenshots to local or flash memory, the image file format is bmp, the lower left corner of the screen status display bar will display the saved screenshots information.

Trace Data▶

Enter the trace data save soft menu, you can choose to save the trace data to the local or flash memory, trace data file format is csv, the bottom left corner of the screen status display trace data saving information.

User State

Save the current system configuration as a user self-defined configuration. Save it in local. The information on saving the user status will display in the status bar of the bottom left corner of the screen.

FAQ

Typical issues that may occur when using your spectrum analyzer:

- Power on malfunction.
- No signal display
- Wrong measurement results or poor frequency or amplitude precision.

Power on malfunction can include a situation where the screen is still dark (no display) after switch on.

Q1. If the screen is still dark after power on

- please check
- Power on malfunction. If the power supply has been connected correctly and if the power supply voltage range is within the specification.
 - If the power switch has been turned on.
 - If the fan is running, please contact us for service.

Q2. There is no signal display at any wave band

A2. Set a signal generator at 30 MHz frequency and -20 dBm power and connect it to the spectrum analyzer RF input connector. If there is still no signal display, there may be a problem with the spectrum analyzer hardware circuit. Please contact GW Instek for service.

Q3. The signal amplitude readout is not precise.

A3. Perform a calibration. If amplitude readout is still not precise, then it may be a problem with internal circuit, please contact GW Instek for service.

Q4 The frequency readout exceed the error range during measurements.

A4. Check if the signal source is stable. If so, check if spectrum analyzer reference is precise. Select internal or external frequency reference according to measurement conditions: press the **FREQ** button → [**frequency reference Internal External**]. If the frequency is still not precise, then the spectrum analyzer LO has lost its phase lock, please contact Combined Test Solutions for a service.

APPENDIX

Specifications

This chapter lists the technical specifications and general technical specifications of the spectrum analyzer. Unless otherwise stated, the technical specifications apply to the following conditions:

- The instrument has been preheated for 30 minutes before use.
- The instrument is in the calibration cycle and has been self-calibrated.

“Typical” and “nominal” for this product are defined as follows:

- Typical: Refers to the performance of the product under certain conditions.
- Nominal: Refers to the approximate value under product application process.

Model	GSP-818
Frequency	
Range	9 kHz to 1.8 GHz
Resolution	1 Hz
Frequency Span	
Span Range	0 Hz, 100 Hz to max. frequency of instrument
Span Uncertainty	$\pm \text{span} / (\text{sweep points} - 1)$
Internal Frequency Reference	
Span Range	10.000000 MHz
Reference Frequency Accuracy	$\pm [(\text{days from last calibrate} \times \text{freq aging rate}) + \text{temperature stability} + \text{initial accuracy}]$

Temperature stability	<2.5ppm (15°C to 35°C)
Aging rate	<1ppm/year
SSB Phase Noise (20°C to 30°C, $f_c=1$ GHz, RBW= 1 kHz, VBW=10 Hz, Average ≥ 40)	
10 kHz	< -82 dBc/Hz
100 kHz	< -98 dBc/Hz(Typical)
1 MHz	< -110 dBc/Hz(Typical)
Bandwidth	
Resolution Bandwidth	10Hz to 500kHz (1-10 steps by sequence), 1MHz, 3MHz
RBW Uncertainty	< 18%, typical (RBW is 3MHz) < 5%, typical (RBW ≤ 1 MHz)
Resolution Filter Shape Factor (60 dB: 3 dB)	<5: 1 typical (digital and close to Gaussian shape)
Video Bandwidth (VBW)	10 Hz to 3 MHz
Amplitude	
Amplitude and level	
Amplitude measurement range	DANL to +10 dBm, 100 kHz to 1 MHz, Preamp Off DANL to +20 dBm, 1 MHz to 1.5 GHz, Preamp Off
Reference Level	-80 dBm to +30 dBm, 0.01dB by step
Preamp	20 dB, nominal, 9 kHz to 1.8 GHz
Input Attenuation	0 to 40 dB, in 1 dB step
Max Input DC Current	50 VDC
Max continuous power	+30dBm, average continuous power
Display Average Noise Level (Input Attenuation= 0 dB, RBW=1 Hz and RBW normalizes to 1 Hz)	
Preamp Off	
1 MHz to 10 MHz	-130 dBm (Typical)
10 MHz to 1 GHz	-130 dBm (Typical)
1 GHz to 1.8 GHz	-128 dBm (Typical)
Preamp On	
1 MHz to 10 MHz	-150 dBm (Typical)
10 MHz to 1 GHz	-150 dBm (Typical)
1 GHz to 1.8 GHz	-148 dBm (Typical)

Frequency response (20°C to 30°C, 30% to 70% relative humidity, input attenuation=10 dB, reference frequency=50 MHz)

Preamp Off ($f_c \geq 100$ kHz) ± 0.8 dB ; ± 0.4 dB, Typical

Preamp On ($f_c \geq 100$ MHz) ± 0.9 dB ; ± 0.5 dB, Typical

Difference and Accuracy

RBW Switch Reference: 10 kHz RBW at 50 MHz
 Difference Log resolution= ± 0.2 dB, Lin resolution= ± 0.01 Nominal

Input Attenuation Difference 20°C ~30°C, $f_c=50$ MHz, Preamplifier Off, 10 dB RF attenuation, input signal 0~40 dB ± 0.5 dB

Absolute Amplitude Uncertainty 20°C to 30°C, $f_c=50$ MHz, Span=200 kHz, RBW=10 kHz, VBW=10 kHz, peak detector, 10 dB RF attenuation, 95% confidence level

Preamp Off ± 0.4 dB, input signal level -20 dBm

Preamp On ± 0.5 dB, input signal level -40 dBm

Uncertainty Input signal range 0 dBm to -50 dBm ± 1.5 dB

VSWR Input 10 dB RF attenuation, 1MHz to 1.8GHz <1.5, Nominal

Distortion and spurious response

Second harmonic distortion $f_c \geq 50$ MHz, Preamp off, signal input -20 dBm, 0 dB RF attenuation, 20°C to 30°C -65 dBc

Third-order intermodulation $f_c \geq 50$ MHz, Input double tone level -20 dBm, frequency interval 100 kHz, input attenuation 0 dB, preamplifier off, 20°C to 30°C +10 dBm

1 dB Gain Compression $f_c \geq 50$ MHz, 0 dB RF attenuation, Preamp off, 20°C to 30°C >+2 dBm, Nominal

Residual response connect 50 Ω load at input port, 0 dB input attenuation, 20°C to 30°C
 <-85 dBm, from 100 kHz to 1.5 GHz
 <-80 dBm, from 1.5 GHz to 1.8 GHz

Input related spurious -30 dBm signal at input mixer, 20°C to 30°C <-60 dBc

Sweep

Time

None-zero Span	10 ms to 3000 s
Zero Span	1 ms to 3000 s
Span Mode	Continue, Single

Tracking Generator (Only apply to - Opt. 01 Tracking Generator)

Tracking Generator Output

Frequency Range	100 kHz to 1.8GHz
Output power level range	-30 dBm to 0 dBm
Output power level resolution	1 dB
Output flatness	± 3 dB
Maximum safe reverse level	Average total power: 30 dBm, DC : ± 50 VDC

Demodulation

Audio Demodulation

Frequency Range	100 kHz to 1.8 GHz
Demodulation Type	FM/AM/USB/LSB

AM Measurement

Frequency Range	10MHz to 1.8GHz
Modulation rate	20Hz to 100kHz
Modulation Rate Accuracy	1Hz, nominal (Modulation rate < 1 kHz) <0.1% modulation rate, nominal (Modulation rate ≥ 1 kHz)
Depth	5% to 95%
Depth Accuracy	$\pm 4\%$, nominal

FM Measurement

Frequency Range	10 MHz to 1.8 GHz
Modulation rate	20 Hz to 100 kHz
Modulation Rate Accuracy	1Hz, nominal (Modulation rate < 1 kHz) <0.1% modulation rate, nominal (Modulation rate ≥ 1 kHz)
Deviation	20 Hz to 200 kHz
Deviation Accuracy	$\pm 4\%$, nominal

Frequency Counter

Counter Resolution	1Hz, 10Hz, 100Hz, 1kHz
Accuracy	\pm (frequency indication \times frequency reference accuracy + counter resolution)

Inputs and Outputs**RF Input**

Impedance	50 Ω , Typical
Connector	N Type Female

Tracking Generator Output

Impedance	50 Ω , Typical
Connector	N Type Female

Reference Input

Connector	BNC Female
10MHz Reference Amplitude	0 dBm to +10 dBm

USB**USB Host**

Connector	A Plug
Protocol	USB 2.0 (Host End)

USB Device

Connector	B Plug
Protocol	2.0 Version

VGA

Connector	15-pins D-SUB(female)
Resolution	800*600, 60 Hz

General Specification**Display**

Type	TFT LCD
Resolution	800*600
Size	10.4 inches
Color	65536

Remote Control

USB	USB TMC
LAN	10/100Base, RJ-45

Mass Memory

Internal Memory	256M Bytes
-----------------	------------

Temperature

Operating Temperature Range	0 °C to 40°C
Storage Temperature Range	-20°C to 70°C

Appearance

Dimensions	421 mm (Width)×221 mm (Height)×115 mm (Depth)
Weight	Approx. 5.0 kg (without package)

GSP-818 Factory Default Settings

The following default settings are the factory configuration settings for GSP-818.

Factory Settings

Parameter	Value
Frequency	
Center Frequency	900.000000 MHz
Start Frequency	0 Hz
Stop Frequency	1.800009000 GHz
Frequency Step	180.000000 MHz
Frequency Offset	0 Hz
Frequency Reference	Internal
SPAN	
Sweep	1.800000000GHz
AMPTD	
Reference Level	0.00dBm
Attenuator	Auto 10 dB
Scale/div	10.00dB
Scale Type	Log
Reference Offset	0.00dB
Unit	dBm
Preamp	Off
BW	
Resolution Bandwidth	Auto 3MHz
Resolution Step	Default
Video Bandwidth	Auto 3MHz
Trace Average	Off
Detector	
Detect Type	Auto
Sweep	
Sweep Time	Auto 20.000ms
Sweep Term	Continuous Sweep
Source	
Tracking Source	Off
Network Measurement	Off
Trace	

Trace	1
Trace Type	Clear Write
Trace 1 Math	1<- ->2

Display

Full Display	Off
Window Zoom	Off
Display Line	Off
Amplitude Scale	Off
Grid	Off
Display Style	Default
Label	On

Trig

Trigger Type	Auto
--------------	------

Demod

Audio Demod	
Digital Demod	

Peak

Peak Search	Off
-------------	-----

Marker Fctn

NdB	Off
Marker Noise	Off
Frequency Count	Off

Marker

Marker	1
Trace	1
Marker List	Off

Meas

Time Spectrum	Off
Adjacent Power	Off
Channel Power	Off
Occupied Bandwidth	Off
pass-fail	Off

Meas Setup

Channel Bandwidth	1.000000MHz
Channel Gap	2.000000MHz
Adjacent Number	3
Occupied Bandwidth	0.99

System

Interface	LAN
IP Address	192.168.1.168

Subnet Mask	255.255.255.0
Gateway	192.168.1.1
Local Language	English
Date/Time	On

Declaration of Conformity

We

COMBINED TEST SOLUTIONS

declare that the below mentioned product

Type of Product: **Spectrum Analyzer**

Model number: **GSP-818**

satisfies all the technical relations application to the product within the scope of council:

Directive: 2014/30/EU; 2014/35/EU; 2011/65/EU; 2012/19/EU

The above product is in conformity with the following standards or other normative documents:

© EMC

EN 61326-1 EN 61326-2-1	Electrical equipment for measurement, control and laboratory use -- EMC requirements (2013)
Conducted & Radiated Emission EN55011: 2009+A1: 2010 Class A	Electrical Fast Transients EN 61000-4-4: 2012
Current Harmonics EN 61000-3-2: 2014	Surge Immunity EN 61000-4-5: 2006
Voltage Fluctuations EN 61000-3-3: 2013	Conducted Susceptibility EN 61000-4-6: 2014
Electrostatic Discharge EN 61000-4-2: 2009	Power Frequency Magnetic Field EN 61000-4-8: 2010
Radiated Immunity EN 61000-4-3: 2006 +A1:2008+A2:2010	Voltage Dip/ Interruption EN 61000-4-11: 2004

© Safety

Low Voltage Equipment Directive 2014/35/EU	
Safety Requirements	EN 61010-1: 2010 EN 61010-2-030: 2010

Combined Test Solutions,
4 Commerce Way, Stanbridge Road,
Leighton Buzzard, LU7 4RW

T: 01525 374466
E: sales@ctstest.co.uk
W: www.ctstest.co.uk

