



Mixed-Domain Oscilloscope

MDO-2000EG & MDO-2000EX

USER MANUAL



ISO-9001 CERTIFIED MANUFACTURER

This manual contains proprietary information, which is protected by copyright. All rights are reserved. No part of this manual may be photocopied, reproduced or translated to another language without prior written consent of Combined Test Solutions.

The information in this manual was correct at the time of printing. However, Combined Test Solutions continues to improve products and reserves the rights to change specification, equipment, and maintenance procedures at any time without notice.

Table of Contents

SAFETY INSTRUCTIONS	4
GETTING STARTED.....	9
MDO-2000EG/2000EX Series Overview	10
Appearance.....	14
Set Up.....	27
Built-in Help	37
MEASUREMENT	38
Basic Measurement	39
Automatic Measurement.....	46
Cursor Measurement	60
Math Operation	67
ADVANCED CONFIGURATION	77
Acquisition	80
Segmented Memory Acquisition	85
Display.....	97
Horizontal View	102
Vertical View (Channel).....	110
Bus Key Configuration.....	118
Trigger	140
Search.....	172
System Settings and Miscellaneous Settings	181
ARBITRARY WAVE GENERATOR	186
Arbitrary Wave Generator Operation ..	187
SPECTRUM ANALYZER.....	220
Spectrum Analyzer operation	221

DMM	239
DMM function	240
POWER SUPPLY	249
Power supply function.....	250
APPLICATIONS	253
Introduction.....	254
Go-NoGo application	256
DVM application	261
Data Log application	263
Digital Filter application	265
Mask application.....	267
SAVE/RECALL	277
File Format/Utility	278
Create/Edit Labels.....	284
Save	287
Recall	295
Reference Waveforms	301
FILE UTILITIES	303
File Navigation	304
Create Folder.....	306
Rename File	307
Delete File or Folder	308
Copy File to USB	309
HARDCOPY KEY	310
REMOTE CONTROL CONFIG	314
Interface Configuration	315
MAINTENANCE	325

FAQ.....331

APPENDIX.....333

 Updating the Firmware 334

 MDO-2000EG/2000EX Specifications. 336

 Probe Specifications 342

 Dimensions 344

 Declaration of Conformity..... 345

INDEX.....346

S SAFETY INSTRUCTIONS

This chapter contains important safety instructions that you must follow during operation and storage. Read the following before any operation to insure your safety and to keep the instrument in the best possible condition.

Safety Symbols

These safety symbols may appear in this manual or on the Product name.



WARNING

Warning: Identifies conditions or practices that could result in injury or loss of life.



CAUTION

Caution: Identifies conditions or practices that could result in damage to the equipment or to other properties.



DANGER High Voltage



(Note)

Attention required
Refer to the Manual



Protective Conductor Terminal



Earth (ground) Terminal



Do not dispose electronic equipment as unsorted municipal waste. Please use a separate collection facility or contact the supplier from which this instrument was purchased.

Safety Guidelines

General Guideline • Make sure the BNC input voltage does not exceed 300Vrms.



WARNING



CAUTION

- Never connect a hazardous live voltage to the ground side of the BNC connectors. It might lead to fire and electric shock.
- Do not place any heavy object on the MDO-2000EG/2000EX.
- Avoid severe impact or rough handling that leads to damaging the MDO-2000EG/2000EX.
- Do not discharge static electricity to the MDO-2000EG/2000EX.
- Use only mating connectors, not bare wires, for the terminals.
- Do not block the cooling fan opening.
- Do not perform measurement at a power source or building installation (Note below).
- Do not disassemble the MDO-2000EG/2000EX unless you are qualified.



Note

(Measurement categories) EN 61010-1:2010 specifies the measurement categories and their requirements as follows. The MDO-2000EG/2000EX falls under category I.

- Measurement category IV is for measurements performed at the source of low-voltage installation.
 - Measurement category III is for measurements performed in the building installation.
 - Measurement category II is for measurements performed on circuits directly connected to the low voltage installation.
 - Measurement category I is for measurement performed on circuits not directly connected to Mains.
-

Power Supply



WARNING

- AC Input voltage: 100 - 240V AC, 50 - 60Hz, auto selection. Power consumption: 40W for MDO-2000EG; 50W for MDO-2000EX.
 - Connect the protective grounding conductor of the AC power cord to an earth ground, to avoid electrical shock.
-

Cleaning the
MDO-
2000EG/2000EX

- Disconnect the power cord before cleaning.
 - Use a soft cloth dampened in a solution of mild detergent and water. Do not spray any liquid.
 - Do not use chemicals containing harsh materials such as benzene, toluene, xylene and acetone.
-

Operation
Environment

- Location: Indoor, no direct sunlight, dust free, almost non-conductive pollution (Note below)
- Relative Humidity: $\leq 80\%$, 40°C or below; $\leq 45\%$, $41^{\circ}\text{C} \sim 50^{\circ}\text{C}$
- Altitude: $< 2000\text{m}$
- Temperature: 0°C to 50°C



Note

(Pollution Degree) EN 61010-1:2010 specifies the pollution degrees and their requirements as follows. The MDO-2000EG/2000EX falls under degree 2.

Pollution refers to "addition of foreign matter, solid, liquid, or gaseous (ionized gases), that may produce a reduction of dielectric strength or surface resistivity".

- Pollution degree 1: No pollution or only dry, non-conductive pollution occurs. The pollution has no influence.
 - Pollution degree 2: Normally only non-conductive pollution occurs. Occasionally, however, a temporary conductivity caused by condensation must be expected.
 - Pollution degree 3: Conductive pollution occurs, or dry, non-conductive pollution occurs which becomes conductive due to condensation which is expected. In such conditions, equipment is normally protected against exposure to direct sunlight, precipitation, and full wind pressure, but neither temperature nor humidity is controlled.
-

Storage environment

- Location: Indoor
 - Temperature: -10°C to 60°C
 - Humidity: Up to 93% RH (non-condensing) / ≤40°C, up to 65% RH (non-condensing) / 41°C ~ 60 °C
-

Disposal



Do not dispose this instrument as unsorted municipal waste. Please use a separate collection facility or contact the supplier from which this instrument was purchased. Please make sure discarded electrical waste is properly recycled to reduce environmental impact.

Power cord for the United Kingdom

When using the oscilloscope in the United Kingdom, make sure the power cord meets the following safety instructions.

NOTE: This lead/appliance must only be wired by competent persons



WARNING: THIS APPLIANCE MUST BE EARTHED

IMPORTANT: The wires in this lead are coloured in accordance with the following code:

Green/ Yellow:	Earth
Blue:	Neutral
Brown:	Live (Phase)



As the colours of the wires in main leads may not correspond with the coloured marking identified in your plug/appliance, proceed as follows:

The wire which is coloured Green & Yellow must be connected to the Earth terminal marked with either the letter E, the earth symbol  or coloured Green/Green & Yellow.

The wire which is coloured Blue must be connected to the terminal which is marked with the letter N or coloured Blue or Black.

The wire which is coloured Brown must be connected to the terminal marked with the letter L or P or coloured Brown or Red.

If in doubt, consult the instructions provided with the equipment or contact the supplier.

This cable/appliance should be protected by a suitably rated and approved HBC mains fuse: refer to the rating information on the equipment and/or user instructions for details. As a guide, a cable of 0.75mm² should be protected by a 3A or 5A fuse. Larger conductors would normally require 13A types, depending on the connection method used.

Any exposed wiring from a cable, plug or connection that is engaged in a live socket is extremely hazardous. If a cable or plug is deemed hazardous, turn off the mains power and remove the cable, any fuses and fuse assemblies. All hazardous wiring must be immediately destroyed and replaced in accordance to the above standard.

G E T T I N G S T A R T E D

This chapter describes the MDO-2000EG/2000EX in a nutshell, including its main features and front / rear panel. After going through the overview, follow the Set Up section to properly set up the device for first time use. The Set Up section also includes an introduction on how to use this manual effectively.



MDO-2000EG/2000EX Series Overview.....	10
Integrated instruments and series lineup	10
Main Features	11
Accessories	12
Appearance.....	14
MDO-2000EG/2000EX 4-channel models Front Panel.....	14
MDO-2000EG Rear Panel.....	22
MDO-2000EX Rear Panel.....	22
Display	24
Set Up	27
Tilt Stand	27
Power Up	28
First Time Use.....	29
How to Use This Manual	32
Built-in Help.....	37

MDO-2000EG/2000EX Series Overview

Integrated instruments and series lineup

The MDO-2000EG and MDO-2000EX have different hardware implemented instruments:

Model name	AWG ⁽¹⁾	DMM ⁽²⁾	SA ⁽³⁾	Power ⁽⁴⁾
MDO-2000EG	✓	✗	✓	✗
MDO-2000EX	✓	✓	✓	✓

(1) Arbitrary Wave Generator

(2) Digital Multi-Meter

(3) Spectrum Analyzer

(4) Power Supply

The MDO-2000EG/2000EX series consists of 12 models, divided into 2-channel and 4-channel versions. Note that throughout the user manual, the term “MDO-2000EG/2000EX” refers to all models of the series, unless stated otherwise.

Model name	Frequency bandwidth	Input channels	Max. Real-time Sampling Rate
MDO-2072EG / 2072EX	70MHz	2	1GSa/s
MDO-2074EG / 2074EX	70MHz	4	1GSa/s
MDO-2102EG / 2102EX	100MHz	2	1GSa/s
MDO-2104EG / 2104EX	100MHz	4	1GSa/s
MDO-2202EG / 2202EX	200MHz	2	1GSa/s
MDO-2204EG / 2204EX	200MHz	4	1GSa/s

Main Features

- Features
- 8 inch, 800 x 480, WVGA TFT display.
 - Available from 70MHz to 200MHz.
 - Real-time sampling rate of 1GSa/s (2 channel models), 1GSa/s max. (4 channel models).
 - Deep memory: 10M points record length.
 - Waveform capture rate of 120,000 waveforms per second.
 - Vertical sensitivity: 1mV/div~10V/div.
 - Segmented Memory: Optimizes the acquisition memory to selectively capture only the important signal details. Up to 29,000 successive waveform segments can be captured with a time-tag resolution of 4ns.
 - Waveform Search: Allows the scope to search for a number of different signal events.
 - Arbitrary Wave generator: Full-function dual channel arbitrary waveform generator.
 - Spectrum Analyzer: A handy tool to perform signal analysis in the frequency domain.
 - DMM: Up to 5000 counts and DCV, DCA, ACV, ACA, R, Diode, Continuity and temperature measurement were supported (MDO-2000EX only)
 - Power Supply: Dual channel output, 1V to 5V continuously adjustable (0.1V step) (MDO-2000EX only)
 - Powerful embedded applications such as: Data Logging, Digital Voltmeter, Go-No Go, Mask, Digital filter, etc..
 - On-screen Help.
 - 32 MB internal flash disk.
-

- Interface
- USB host port: front panel, for storage devices.
 - USB device port: rear panel, for remote control or printing.
 - Ethernet port as standard.
 - Probe compensation output with selectable output frequency (1kHz ~ 200kHz).
 - Calibration output.

Accessories

Standard Accessories	Part number	Description
	N/A region dependent	Power cord
	GTP-70B-4, for MDO-2072EG/2072EX MDO-2074EG/2074EX	Passive probe; 70 MHz
	GTP-100B-4, for MDO-2102EG/2102EX MDO-2104EG/2104EX	Passive probe; 100 MHz
	GTP-200B-4, for MDO-2202EG/2202EX MDO-2204EG/2204EX	Passive probe; 200 MHz
	GTL-105A	Test lead for power supply (for MDO-2000EX only).
	GTL-110	Test lead for AGW.
	GTL-207	Test lead for DMM (for MDO-2000EX only).
Standard Apps	Name	Description
	Go-NoGo	Go-NoGo testing app.
	DataLog	Waveform or image data logging app.
	DVM	Digital Voltmeter app.

	Digital Filter	High ,low or band pass digital filter for analog inputs.
	Mask	Creates shape templates for signal comparison.
	Remote Disk	Allows the scope to mount a network share drive.
	Demo mode	Demonstration mode that is used with the GDB-03 demo board.
Optional Accessories	Part number	Description
	GDB-03	Demo board.
Drivers, others	USB driver	LabVIEW driver

Appearance

MDO-2000EG/2000EX 4-channel models Front Panel

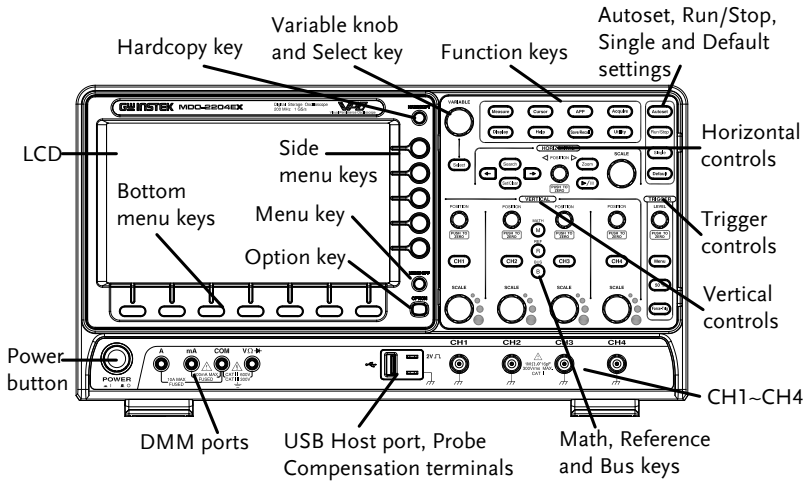

MDO-2000EG/2000EX 2-channel models Front Panel

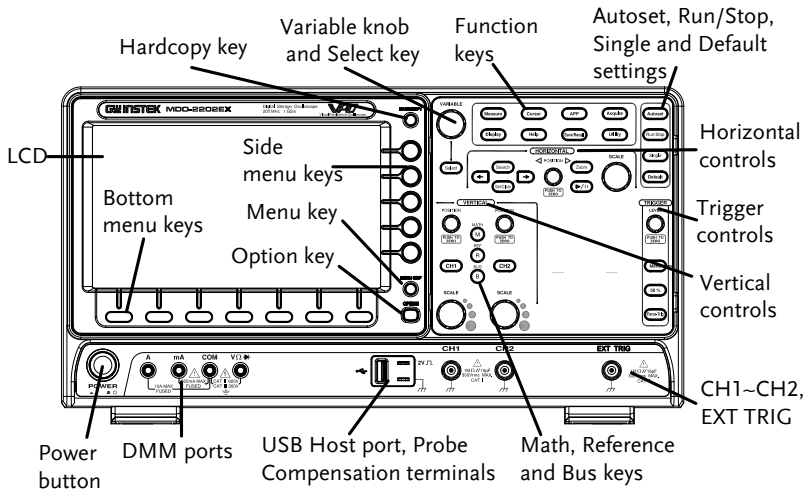

LCD Display 8" WVGA TFT color LCD. 800 x 480 resolution, wide angle view display.

Menu Off Key **MENU OFF** Use the Menu Off key to hide the onscreen menu system.



Option Key **OPTION** The Option key is used to access installed options.



Menu Keys The side menu and bottom menu keys are used to make selections from the soft-menus on the LCD user interface.

To choose menu items, use the 7 Bottom menu keys located on the bottom of the display panel.

To select a variable or option from a menu, use the side menu keys on the side of the panel. See page 32 for details.

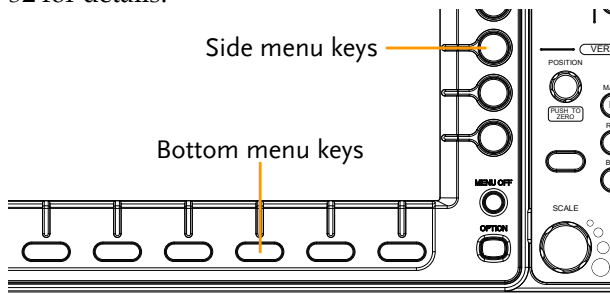

Hardcopy Key **HARDCOPY** The Hardcopy key is a quick-save or quick-print key, depending on its configuration. For more information see pages 312 (save) or 311 (print).



Variable Knob
and Select Key

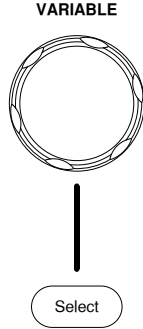

The Variable knob is used to increase/decrease values or to move between parameters.

The Select key, when lit up, is used to make selections.

Function Keys

The Function keys are used to enter and configure different functions on the MDO-2000EG/2000EX.

Measure



Configures and runs automatic measurements.

Cursor



Configures and runs cursor measurements.

APP



Configures and runs GW Instek applications.

Acquire



Configures the acquisition mode, including Segmented Memory acquisition.

Display



Configures the display settings.

Help





Shows the Help menu.



Save/Recall

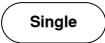
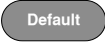

Used to save and recall waveforms, images, panel settings.



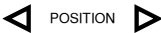



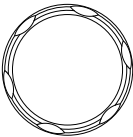

- Utility  Configures the Hardcopy key, display time, language, probe compensation and calibration. It also accesses the file utilities menu.
- Autoset  Press the Autoset key to automatically set the trigger, horizontal scale and vertical scale.
- Run/Stop Key  Press to Freeze (Stop) or continue (Run) signal acquisition (page 42). The run stop key is also used to run or stop Segmented Memory acquisition (page 88).
- Single  Sets the acquisition mode to single triggering mode.
- Default Setup  Resets the oscilloscope to the default settings.

Horizontal Controls The horizontal controls are used to change the position of the cursor, set the time base settings, zoom into the waveforms/traces and search for events.

Horizontal Position  POSITION  The Position knob is used to position the waveforms/traces horizontally on the display screen. Pressing the knob will reset the position to zero.

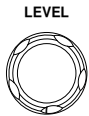
PUSH TO ZERO

SCALE  SCALE The Scale knob is used to change the horizontal scale (TIME/DIV).

Zoom		Press Zoom in combination with the horizontal Position knob.
Play/Pause		The Play/Pause key allows you to view each search event in succession – to effectively “play” through each search event. It is also used to play through a waveform/trace in zoom mode.
Search		The Search key accesses the search function menu to set the search type, source and threshold.
Search Arrows		Use the arrow keys to navigate the search events.
Set/Clear		Use the Set/Clear key to set or clear points of interest when using the search function.
Trigger Controls	The trigger controls are used to control the trigger level and options.	
Level Knob		Used to set the trigger level. Pressing the knob will reset the level to zero.
Trigger Menu Key		Used to bring up the trigger menu.
50% Key		Sets the trigger level to the half way point (50%).
Force - Trig		Press to force an immediate trigger of the waveform.

Vertical
POSITION



Sets the vertical position of the waveform/trace. Push the knob to reset the vertical position to zero.

Channel Menu
Key



Press the CH1~4 key to set and configure the corresponding channel.

(Vertical)SCALE
Knob

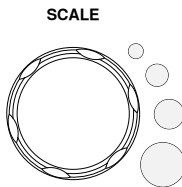

Sets the vertical scale of the channel (TIME/DIV).

External Trigger
Input

EXT TRIG



Accepts external trigger signals (page 140). Only on 2 channel models.

Input impedance: $1M\Omega$
Voltage input: $\pm 15V$ (peak), EXT
trigger capacitance: $16pF$.

Math Key



Use the Math key to set and configure math functions.

Reference Key



Press the Reference key to set or remove reference waveforms.

BUS Key



The Bus key is used for serial bus (UART, I²C, SPI, CAN, LIN) configuration.

Channel Inputs

CH1

Accepts input signals.
Input impedance: $1M\Omega$.
Capacitance: $16pF$
CAT I



USB Host Port

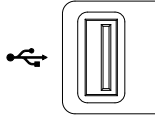

Type A, 1.1/2.0 compatible. Used for data transfer.

Ground Terminal

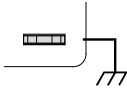

Accepts the DUT ground lead for common ground.

Probe Compensation Output



The probe compensation output is used for probe compensation. It also has an adjustable output frequency.

By default this port outputs a $2V_{pp}$, square wave signal at $1kHz$ for probe compensation.

Please see page 184 for details.

Power Switch



Used to turn the power on/off.

■ I: ON

■ O: OFF

DMM Ports

(For MDO-2000EX only)

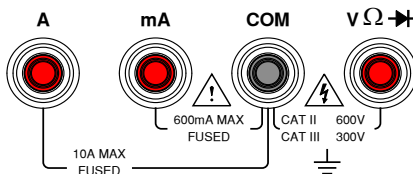

mA	Accepts up to 600mA. Fuse protection: 1A.
A	Accepts up to 10A. Fuse protection: 10A
COM	Com port
$V \Omega \rightarrow$	Voltage, Resistance and Diode port. Max voltage: 600V

MDO-2000EG Rear Panel

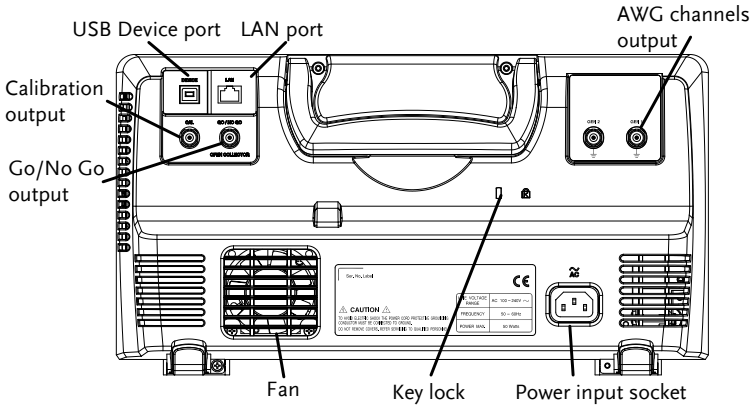

MDO-2000EX Rear Panel

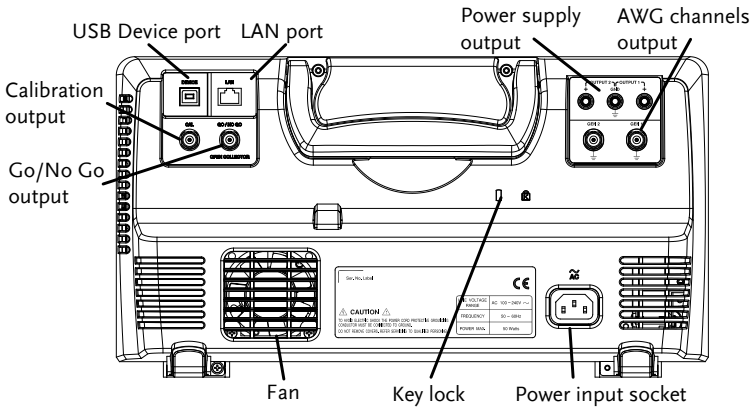

Calibration Output



Outputs the signal for vertical scale accuracy calibration (page 327).

USB Device Port

DEVICE

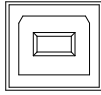

The USB Device port is used for remote control.

LAN (Ethernet) Port

LAN

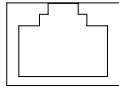

The LAN port is used for remote control over a network or when combined with the Remote Disk app, allows the scope to be mounted to a share disk.

Power Input Socket

AC

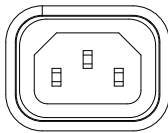

Power cord socket accepts AC mains, 100 ~ 240V, 50/60Hz.

For power up sequence, see page 28.

Security Slot



Kensington security slot compatible.

Go-No Go Output

GO / NO GO



Outputs Go-No Go test results (page 256) as a 500us pulse signal.

OPEN COLLECTOR

AWG Output

GEN 1



Output the GEN1 or GEN2 signal from the Arbitrary Wave Generator function. (see page 188).

Power Supply outputs

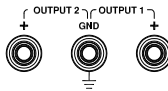



5V/1A Dual power supply outputs, (For MDO-2000EX only, see page 249).

Display

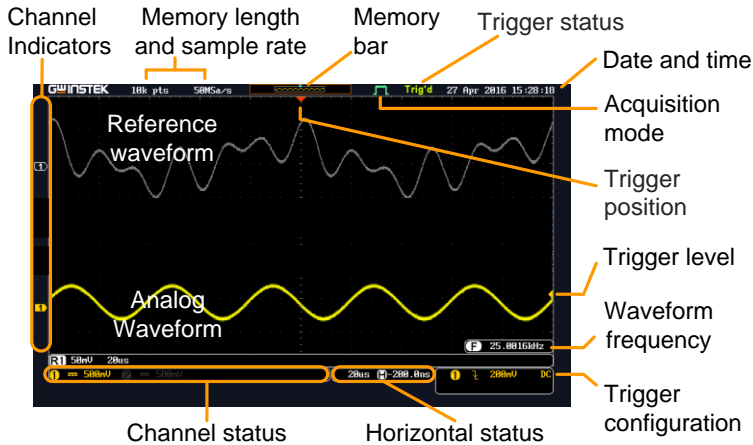
Below is a general description of the main display. As the display changes while activating the different functions of the MDO-2000EG/2000EX, please refer to each function sub-chapters of this user manual for more details.



Analog Waveforms	Shows the analog input signal waveforms. Channel 1: Yellow Channel 2: Blue Channel 3: Pink Channel 4: Green
Bus decoding	Shows serial bus data decoding. The values are displayed in hex or binary.
Reference waveform	Reference waveform(s) can be displayed for reference, comparison or other operations.
Channel Indicators	The channel indicators for each activated channels are located at the zero volt level of each signals. Any active channel is shown with a solid color. Example:  Analog channel indicator  Reference waveform indicator  Math indicator

Trigger Position	Shows the position of the trigger.	
Horizontal Status	Shows the horizontal scale and position.	
Date and Time		Current date and time (page 183).
Trigger Level		Shows the trigger level on the graticule.
Memory Bar		The ratio and the position of the displayed waveform compared to the internal memory (page 102).
Trigger Status	Trig'd	Triggered.
	PrTrig	Pre-trigger.
	Trig?	Not triggered, display not updated.
	Stop	Trigger stopped. Also appears in Run/Stop (page 42).
	Roll	Roll mode.
	Auto	Auto trigger mode.
	For trigger details, see page 140.	
Acquisition Mode		Normal mode
		Peak detect mode
		Average mode
For acquisition details, see page 80.		
Signal Frequency		Shows the trigger source frequency.
		Indicates the frequency is less than 2Hz (lower frequency limit).
Trigger Configuration		Trigger source, slope, voltage and coupling.
Horizontal Status		Horizontal scale, horizontal position.

For trigger details, see page 140.

Channel Status



Channel 1, DC coupling,
2V/Div.

For channel details, see page 110.

Set Up

Tilt Stand

Tilt

To tilt, pull the legs forward, as shown below.

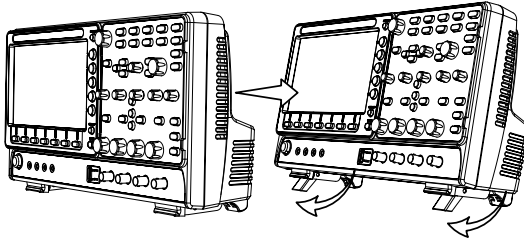

Stand

To stand the scope upright, push the legs back under the casing as shown below.

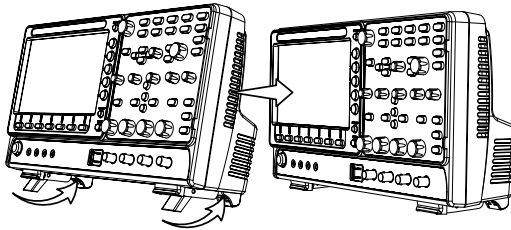

Power Up

Requirements The MDO-2000EG/2000EX accepts line voltages of 100 ~ 240V at 50 or 60Hz.

Step 1. Connect the power cord to the rear panel socket.

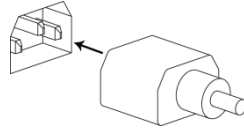

2. Press the POWER key. The display becomes active in ~ 30 seconds.

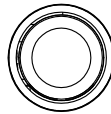

 : ON
 : OFF

POWER
 



Note

The MDO-2000EG/2000EX recovers the state right before the power is turned OFF. The default settings can be recovered by pressing the Default key on the front panel. For details, see page 296.

First Time Use

Background	This section describes how to connect, adjust the scale and compensate the probe. Before operating the MDO-2000EG/2000EX in a new environment, run these steps to make sure the instrument performs at its full potential.	
1. Power On	Follow the procedures on the previous page.	
2. Firmware	Update to the latest firmware.	Page 334
3. Set the Date and Time	Set the date and time.	Page 183.
4. Reset System	Reset the system by recalling the factory settings. Press the <i>Default</i> key on the front panel. For details, see page 296.	
5. Connect the probe	Connect the probe that you will use for measurements to the Channel 1 input and to the probe compensation output. This output provides by default a 2V peak to peak, 1kHz square wave for signal compensation. Set the probe attenuation to x10 if the probe has adjustable attenuation.	

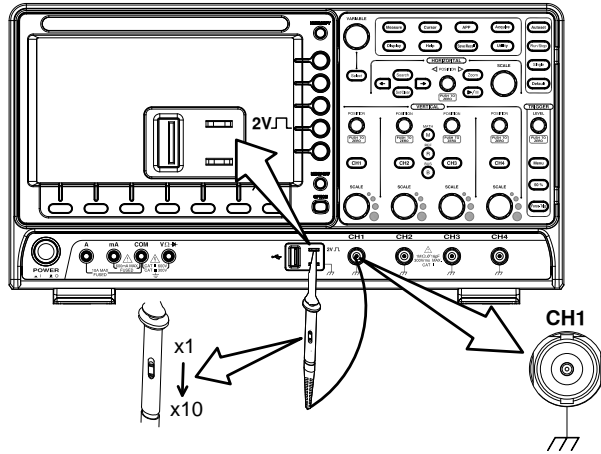

6. Capture Signal (Autoset) Press the *Autoset* key. A square waveform appears on the center of the screen. For Autoset details, see page 40.

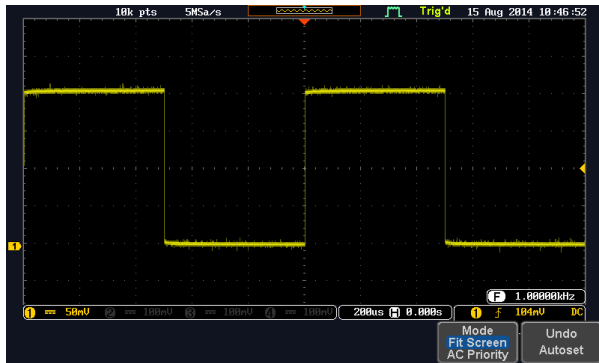

7. Select Vector Waveform Press the *Display* key, and set the display to *Vector* on the bottom menu.

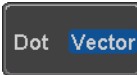
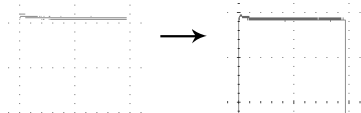

8. Compensate the probe

Turn the adjustment point on the probe to make the square waveform as flat as possible.

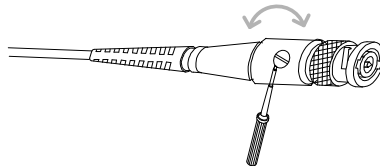
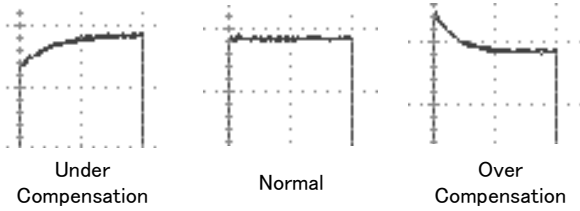

9. Start operations Continue with the other operations.

Measurement: page 38 Configuration: page 77

Using the Spectrum Analyzer: page 220. Using the Power Supply: page 249.

Using the DMM: page 239. Applications: page 220

Save/Recall: page 277 File Utilities: page 303

Hardcopy key: page 310 Remote Control: page 314

Maintenance: page 325

How to Use This Manual

Background

This section describes the conventions used in this manual to operate the MDO-2000EG/2000EX.

Throughout the manual any reference to pressing a menu key refers to the keys directly below or beside any menu icons or parameters.

When the user manual says to “toggle” a value or parameter, press the corresponding menu item. Pressing the item will toggle the value or parameter.

Active parameters are highlighted for each menu item. For example in the example below, Coupling is currently set to DC.

If a menu item can be toggled from one value or parameter to another, the available options will be visible, with the current option highlighted. In the example below the slope can be toggled from a rising slope to a falling slope or either slope.

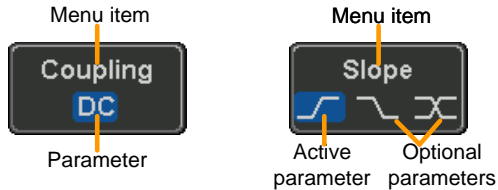

Selecting a Menu Item, Parameter or Variable

When the user manual says to “select” a value from one of the side menu parameters, first press the corresponding menu key and use the Variable knob to either scroll through a parameter list or to increase or decrease a variable.

Example 1

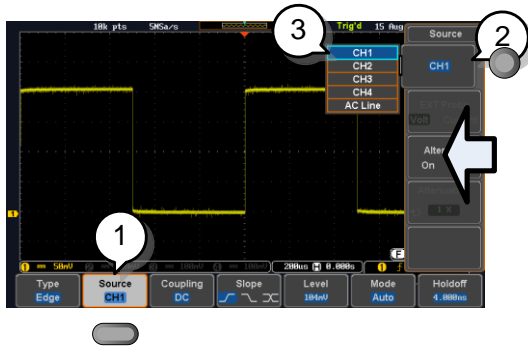

- 3. Press a bottom menu key to access the side menu.



- 4. Press a side menu key to either set a parameter or to access a sub menu.



- 5. If accessing a sub menu or setting a variable parameter, use the Variable knob to scroll through menu items or variables. Use the Select key to confirm and exit. The Select key is lit-up when such selection can be made.

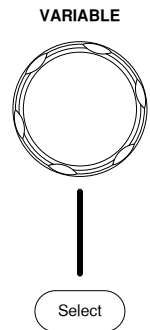

- 6. Press the same bottom menu key again to reduce the side menu.



Example 2

For some variables, a circular arrow icon indicates that the variable for that menu key can be edited with the Variable knob.

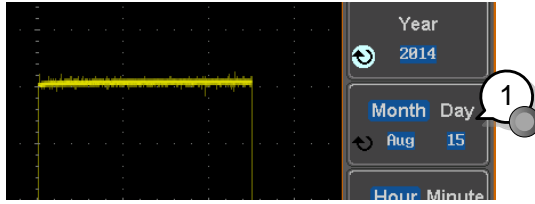

7. Press the desired menu key to select it. The circular arrow will become highlighted.

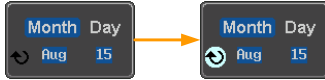

8. Use the Variable knob to edit the value.

toggling a Menu Parameter

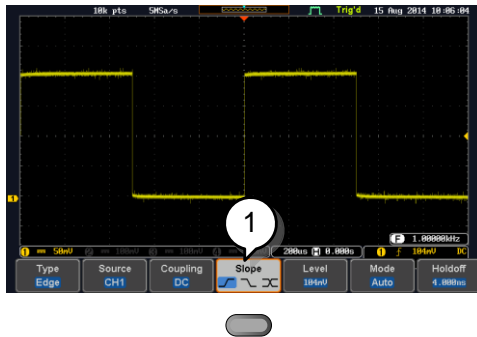

9. Press the bottom menu key to toggle the parameter.



Reduce Side Menu

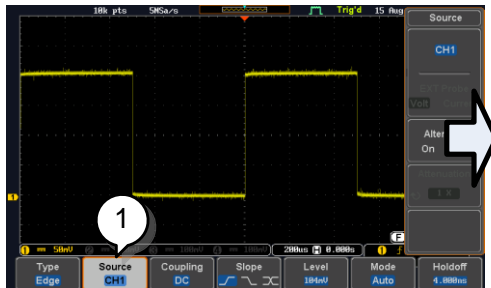

- To reduce the side menu, press the corresponding bottom menu that brought up the side menu.

For example: Press the *Source* soft-key to reduce the Source menu.

Reduce Lower Menu

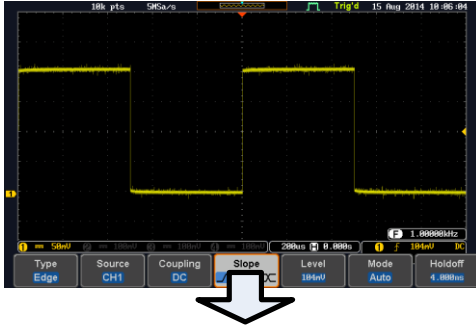

- Press the relevant function key again to reduce the bottom menu. For example: press the Trigger Menu key to reduce the trigger menu.

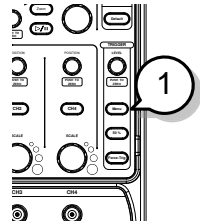

Remove All Menus

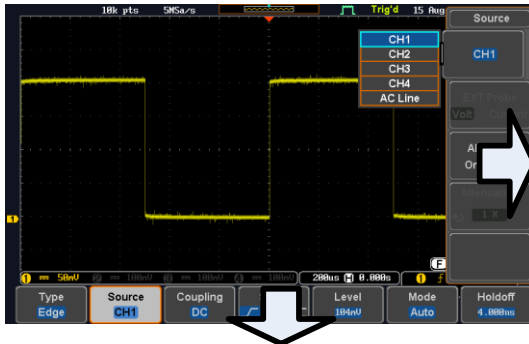

12. Press the *Menu Off* key to reduce the side menu, press again to reduce the bottom menu.

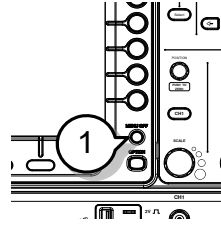

Remove On-Screen Messages

13. The *Menu Off* key can also be used to remove any on screen messages.

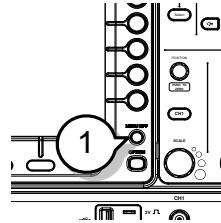



Built-in Help

The Help key accesses a context sensitive help menu. The help menu contains information on how to use the front panel keys.

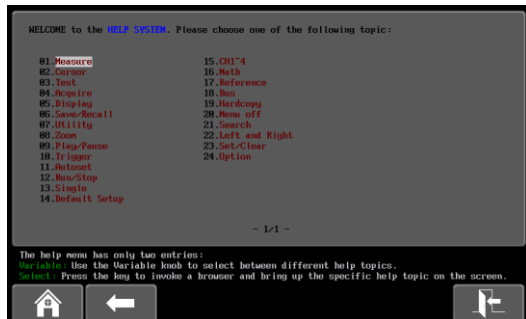

- Panel Operation
1. Press the *Help* key. The display changes to Help mode. 
 2. Use the *Variable* knob to scroll up and down through the Help contents. Press *Select* to view the help on the selected item.

Example: Help on the Display key



Home Key Press the *Home* key to return to the main help screen. 

Go Back Press the *Back* key to go to the previous menu page. 

Exit Press the *Help* key again or press the *Exit* key to exit the Help mode. 

M EASUREMENT

Basic Measurement	39
Channel Activation	39
Autoset	40
Run/Stop	42
Horizontal Position/Scale	43
Vertical Position/Scale	45
Automatic Measurement.....	46
Measurement Items	46
Add Measurement.....	50
Remove Measurement.....	52
Gated mode.....	53
Display All mode.....	54
High Low Function	55
Statistics	56
Reference Levels	58
Cursor Measurement	60
Use Horizontal Cursors	60
Use Vertical Cursors	63
Math Operation	67
Basic Math Overview & Operators	67
Addition/Subtraction/Multiplication/Division	67
FFT Overview & Window Functions	69
FFT Operation	70
Advanced Math Overview.....	72
Advanced Math Operation.....	73

Basic Measurement

This section describes the basic operations required in capturing, viewing and measuring the input signal. For more detailed or more specific operations, see the following chapters.

- Advanced Configuration → from page 77
- Arbitrary Wave Generator → from page 186
- Spectrum Analyzer → from page 220
- Digital Multi-meter (MDO-2000EX only) → from page 239
- Power Supply (MDO-2000EX only) → from page 249
- Applications → from page 253

Before operating the oscilloscope, please see the Getting Started chapter, page 9.

Channel Activation

Activate Channel To activate an input channel, press a *channel* key.

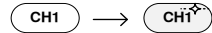

When activated, the channel key will light up. The corresponding channel menu will also appear.

Each channel is associated with the color shown beside each channel's vertical SCALE dial: CH1: yellow, CH2: blue, CH3: pink and CH4: green.

When a channel is activated, it is shown above the bottom menu system.

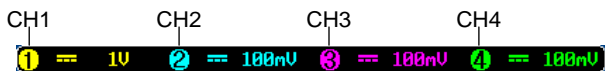

De-activate Channel To de-activate a channel, press the corresponding *channel* key again. If the channel menu is not open, press the *channel* key twice (the first press shows the Channel menu).

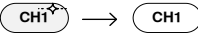

Default Setup To activate the default state, press *Default* (this will reset the system and recall the factory defaults, see page 296).



Autoset

Background The Autoset function automatically configures the panel settings to position the input signal(s) to the best viewing condition. The MDO-2000EG/2000EX automatically configures the following parameters:

- Horizontal scale
- Vertical scale
- Trigger source channel

There are two operating modes for the Autoset function: Fit Screen Mode and AC Priority Mode.

Fit Screen Mode will fit the waveform to the best scale, including any DC components (offset). AC priority mode will scale the waveform to the screen by removing any DC component.

Panel Operation

1. Connect the input signal to the MDO-2000EG/2000EX and press the *Autoset* key.
2. The waveform appears in the center of the display.



Before

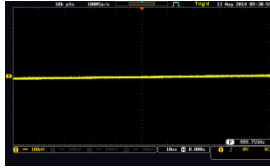

After



3. To undo Autoset, press *Undo Autoset* from the bottom menu.

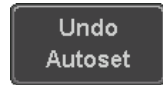

Change modes

4. Choose between *Fit Screen Mode* and *AC Priority Mode* from the bottom menu.



5. Press the *Autoset* key again to use Autoset in the new mode.



Fit Screen Mode

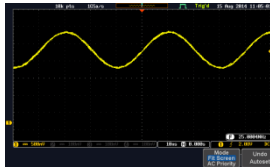

AC Priority



Limitation

Autoset does not work in the following situations:



- Input signal frequency is less than 20Hz
- Input signal amplitude is less than 10mV



The Autoset key does NOT automatically activate the channels to which input signals are connected.

Run/Stop

Background By default, the waveform on the display is constantly updated (Run mode). Freezing the waveform by stopping signal acquisition (Stop mode) allows flexible observation and analysis. To enter Stop mode, two methods are available: pressing the Run/Stop key or using the Single Trigger mode.

Stop mode icon  When in Stop mode, the
 Triggered icon  Stop icon appears at the
 top of the display.

Freeze Waveform using the Run/Stop Key Press the *Run/Stop* key once. The Run/Stop key turns red. The waveform and signal acquisition freezes.

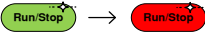
Stop: 

To unfreeze, press the *Run/Stop* key again. The Run/Stop key turns green again.

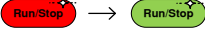
Run: 

Freeze Waveform by Single Trigger Mode Press the *Single* key to go into the Single Trigger mode. The Single key turns bright white.

In the Single Trigger mode, the scope will be put into the pre-trigger mode until the scope encounters the next trigger point. After the scope has triggered, it will remain in Stop mode, until the *Single* key is pressed again or the *Run/Stop* key is pressed.

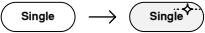

Waveform Operation The waveform can be moved or scaled in both Run and Stop mode, but in different manners. For details, see page 102 (Horizontal position/scale) and page 110 (Vertical position/scale).

Horizontal Position/Scale

For more detailed configuration, see page 102.

Set Horizontal Position

The horizontal position knob moves the waveform left and right.

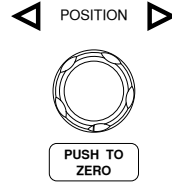

Set Horizontal Position to 0

Pressing the horizontal position knob will reset the horizontal position to 0.

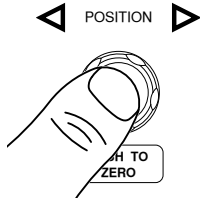

Alternatively, pressing the *Acquire* key and then pressing *Reset H Position to 0s* from the bottom menu will also reset the horizontal position.



As the waveform moves, the display bar on the top of the display indicates the portion of the waveform currently shown on the display and the position of the horizontal marker on the waveform.



Position Indicator The horizontal position is shown at the bottom of the display grid to the right of the H icon.



Select Horizontal Scale To select the timebase, turn the horizontal SCALE knob; left (slow) or right (fast).

SCALE

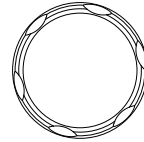

Range 1ns/div ~ 100s/div, 1-2-5 increments
 The scale is displayed to the left of the H icon at the bottom of the screen.



Display bar The display bar indicates how much of the waveform is displayed on the screen at any given time. Changes to timebase will be reflected on the display bar.



Stop mode In the Stop mode, the waveform size changes according to the scale.

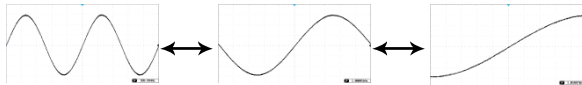

Note

The Sample rate changes according to the timebase and record length. See page 84.

Vertical Position/Scale

For more detailed configuration, see page 110.

Set Vertical Position

To move the waveform up or down, turn the *vertical position knob* for each channel.



Push the *vertical position knob* to reset the position to 0.

As the waveform moves, the vertical position of the channel indicator appears on the display.

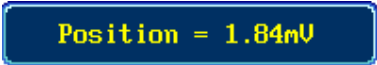
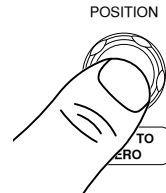

Run/Stop mode

The waveform can be moved vertically in both Run and Stop mode.

Select Vertical Scale

To change the vertical scale, turn the vertical *SCALE knob*; left (down) or right (up).

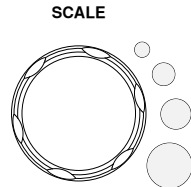

Range

1mV/div ~ 10V/div
1-2-5 increments

The vertical scale indicator for each channel on the bottom of the display changes accordingly.







Automatic Measurement

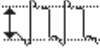
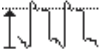
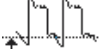
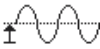

The automatic measurement function measures and updates major items for Voltage/Current, Time, and Delay type measurements.

Measurement Items

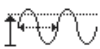

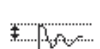







	V/I Measurements	Time Meas.	Delay Meas.			
Overview	Pk-Pk		Frequency		FRR	
	Max		Period		FRF	
	Min		RiseTime		FFR	
	Amplitude		FallTime		FFF	
	High		+Width		LRR	
	Low		-Width		LRF	
	Mean		Dutycycle		LFR	
	Cycle Mean		+Pulses		LFF	
	RMS		-Pulses		Phase	
	Cycle RMS		+Edges			
	Area		-Edges			
	Cycle Area		% Flicker			
	ROVShoot		Flicker Idx			
	FOVShoot					
	RPREShoot					
	FPREShoot					











Voltage/Current Measurement	Pk-Pk (peak to peak)		Difference between positive and negative peak. (=max - min)
	Max		Positive peak.
	Min		Negative peak.

Amplitude		Difference between the global high value and the global low value, measured over the entire waveform or gated region. (=high - low)
High		Global high voltage. See page 55 for details.
Low		Global low voltage. See page 55 for details.
Mean		The arithmetic mean value is calculated for all data samples as specified by the Gating option.
Cycle Mean		The arithmetic mean value is calculated for all data samples within the first cycle found in the gated region.
RMS		The root mean square of all data samples specified by the Gating option.
Cycle RMS		The root mean square value is calculated for all data samples within the first cycle found in the gated region.
Area		Measures the positive area of the waveform and subtracts it from the negative area. The ground level determines the division between positive and negative areas.
Cycle Area		The Summation based on all data samples within the first cycle found in the gated region.
ROVShoot		Rise overshoot

FOVShoot		Fall overshoot
RPREShoot		Rise preshoot
FPREShoot		Fall preshoot

Time Measurement

Frequency		Frequency of the waveform.
Period		Waveform cycle time. (=1/Freq)
RiseTime		The time required for the leading edge of the first pulse to rise from the low reference value to the high reference value.
FallTime		The time required for the falling edge of the first pulse to fall from the high reference value to the low reference value.
+Width		Positive pulse width.
-Width		Negative pulse width.
Duty Cycle		Ratio of signal pulse compared with whole cycle. =100x (Pulse Width/Cycle)
+Pulses		Measures the number of positive pulses.
-Pulses		Measures the number of negative pulses.
+Edges		Measures the number of positive edges.

	-Edges		Measures the number of negative edges.
	% Flicker		Ratio in percentage of the peak-to-peak value to the sum of peak values.
	Flicker Idx		Ratio of the area above the average to the total area during one cycle.
Delay Measurement	FRR		Time between: Source 1 first rising edge and Source 2 first rising edge.
	FRF		Time between: Source 1 first rising edge and Source 2 first falling edge.
	FFR		Time between: Source 1 first falling edge and Source 2 first rising edge.
	FFF		Time between: Source 1 first falling edge and Source 2 first falling edge.
	LRR		Time between: Source 1 first rising edge and Source 2 last rising edge.
	LFR		Time between: Source 1 first rising edge and Source 2 last falling edge.
	LRF		Time between: Source 1 first falling edge and Source 2 last rising edge.
	LFF		Time between: Source 1 first falling edge and Source 2 last falling edge.

Phase  The phase difference of two signals, calculated in degrees.

$$\frac{t1}{t2} \times 360^\circ$$

Note

The in-built help system can be used to see detailed automatic measurement definitions.

Add Measurement

The *Add Measurement* function allows you to add up to eight automatic measurement items on the bottom of the screen from any channel source.

Add Measurement Item

1. Press the *Measure* key.
2. Press *Add Measurement* from the bottom menu.
3. Choose either a *V/I*, *Time* or *Delay* measurement from the side menu and choose the type of measurement you wish to add.

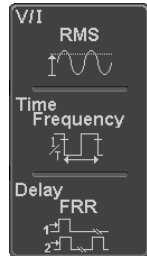
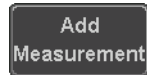

V/I (Voltage/ Current)	Pk-Pk, Max, Min, Amplitude, High, Low, Mean, Cycle Mean, RMS, Cycle RMS, Area, Cycle Area, ROVShoot, FOVShoot, RPREShoot, FPREShoot
Time	Frequency, Period, RiseTime, FallTime, +Width, -Width, Duty Cycle, +Pulses, -Pulses, +Edges, -Edges, %Flicker, FlickerIndex

Delay FRR, FRF, FFR, FFF, LRR, LRF, LFR, LFF, Phase

- All of the chosen automatic measurements will be displayed in a window on the bottom of the screen. The channel number and channel color indicate the measurement source.
For the analog inputs: yellow = CH1, blue = CH2, pink = CH3, green = CH4.



Choose a Source The channel source for measurement items can be set either before or when selecting a measurement item.

- To set the source, press either the *Source1* or *Source2* key from the side menu and choose the source.



Range Source1: CH1~CH4, Math
Source2: CH1~CH4, Math

 (Note)

Source 2 is only applicable to Delay measurements.

Only selected Time Frequency measurements can be applied to Frequency, Period, +Width, -Width and Dutycycle.

Remove Measurement

Individual measurements can be removed at any time using the Remove Measurement function.

Remove
Measurement
Item

1. Press the *Measure* key.

A light gray, rounded rectangular button with the word "Measure" in a dark gray font.

2. Press *Remove Measurement* from the bottom menu.

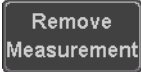
A dark gray, rounded rectangular button with the words "Remove Measurement" in a light gray font, stacked vertically.

3. Press *Select Measurement* and select the item that you want to remove from the measurement list.

A dark gray, rounded rectangular button with the words "Select Measurement" in a light gray font, stacked vertically.

Remove All Items Press *Remove All* to remove all the measurement items.

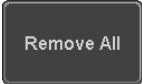
A dark gray, rounded rectangular button with the words "Remove All" in a light gray font.

Gated mode

Some automatic measurements can be limited to a “gated” area between cursors. Gating is useful for measuring a magnified waveform or when using a fast time base. The Gated mode has three possible configurations: Off (Full Record), Screen and Between Cursors.

Set Gating Mode 1. Press the *Measure* key.



2. Press *Gating* from the bottom menu.

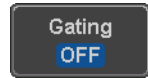

3. Choose one of the gating modes from the side menu: *Off (full record)*, *Screen*, *Between Cursors*.

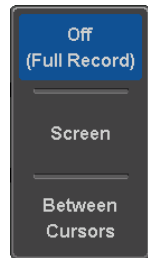

Cursors On
Screen

If *Between Cursors* is selected, the cursor positions can be edited by using the cursor menu.

Page 60

Display All mode

Display All mode shows and updates all items from Voltage and Time type measurements.

View Measurement Results

1. Press the *Measure* key.



2. Press *Display All* from the bottom menu.

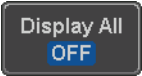

3. Press Source from the side menu and choose a measurement source.



Range CH1~CH4, Math

4. The results of Voltage and Time type measurements appear on the display.



Remove Measurements

To remove the measurement results, press *OFF*.



Delay Measurements

Delay type measurements are not available in this mode as only one channel is used as the source. Use the individual measurement mode (page 50) instead.

High Low Function

Background The High-Low function is used to select the method for determining the value of the High-Low measurement values.

Auto Automatically chooses the best high-low setting for each waveform when measuring.

Histogram Uses histograms to determine the high-low values. This mode ignores any pre-shoot or overshoot values. This mode is particularly useful for pulse-type waveforms

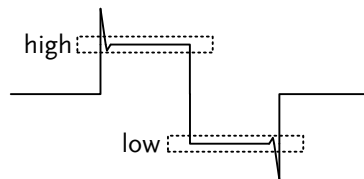

Min-max Sets the high-low values as the minimum or maximum measured values.

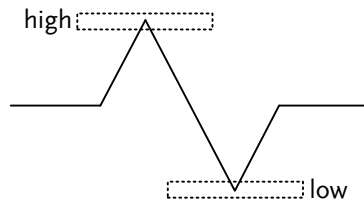

Set High-Low 1. Press the *Measure* key.

2. Press *High-Low* from the bottom menu.

3. Select the type of High-Low settings from the side menu.

High-Low Settings: Histogram, Min-Max, Auto

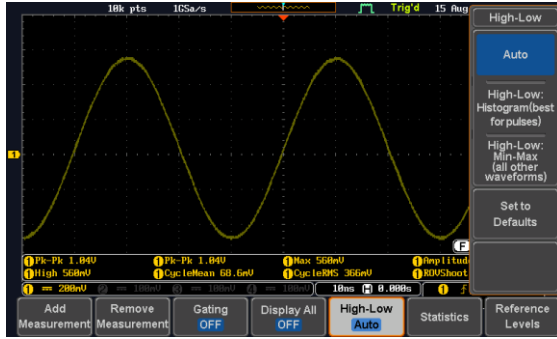

Restore Default High-Low Settings

To return to the default High-Low settings, press *Set to Defaults*.

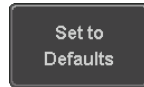



Statistics

Background

The Statistics function can be used to view a number of statistics for the selected automatic measurements. The following information is displayed with the Statistics function:

Value	Currently measured value
Mean	The mean value is calculated from a number of automatic measurement results. The number of samples used to determine the mean can be user-defined.
Min	The minimum value observed from a series of measured results for the selected automatic measurement items.

Max	The maximum value observed from a series of measured results for the selected automatic measurement items.
Standard Deviation	The variance of the currently measured value from the mean. The standard deviation equals the squared root of the variance value. Measuring the standard deviation can, for example, determine the severity of jitter in a signal. The number of samples used to determine the standard deviation can be user-defined.

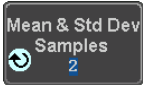
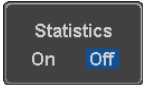
- Panel Operation
1. Press the *Measure* key. 
 2. Select at least one automatic measurement. Page 50
 3. Press *Statistics* from the bottom menu. 
 4. Set the number of samples to be used in the mean and standard deviation calculations. 
 Samples: 2~1000
 5. Press *Statistics* and turn Statistics on. 
 6. The statistics for each automatic measurement will appear at the bottom of the display in a table.



Reset Statistics To reset the standard deviation calculations, press *Reset Statistics*.

Reference Levels

Background

The reference level settings determine the measurement threshold levels for some measurements like the Rise Time measurement.

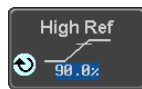

High Ref: Sets the high reference level.

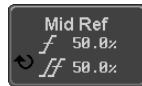

Mid Ref: Sets the middle reference for the first and second waveforms.

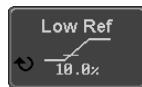

Low Ref: Sets the low reference level.

Panel Operation 1. Press the *Measure* key.

2. Press *Reference Levels* from the bottom menu.

3. Set the reference levels from the side menu.

Ensure the reference levels do not cross over.

High Ref 0.0% ~ 100%

Mid Ref 0.0% ~ 100%

0.0% ~ 100%

Low Ref 0.0% ~ 100%

- Default Settings
4. Press *Set to Defaults* to set the reference levels back to the default settings.

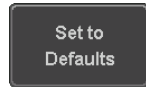

Cursor Measurement

Horizontal or vertical cursors are used to show the position and values of waveform measurements and math operation results. These results cover voltage, time, frequency and other math operations. When the cursors (horizontal, vertical or both) are activated, they will be shown on the main display unless turned off.

Use Horizontal Cursors

Panel Operation 1. Press the *Cursor* key once.



2. Press *H Cursor* from the bottom menu if it is not already selected.



3. When the H Cursor is selected, repeatedly pressing the *H Cursor* key or the *Select* key will toggle which cursor is selected.



OR



Range	Description
∷	Left cursor (1) movable, right cursor position fixed
∷	Right cursor (2) movable, left cursor position fixed
	Left and right cursor (1+2) movable together

4. The cursor position information appears on the top left hand side of the screen

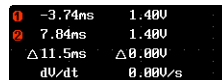

Cursor 1	Hor. position, Voltage/Current
Cursor 2	Hor. position, Voltage/Current
Δ	Delta (difference between cursors)
dV/dt or dI/dt	

- Use the *Variable* knob to move the movable cursor(s) left or right.

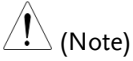

The selected cursor(s) will move along the active waveform. To move along another waveform, select its corresponding channel and press the cursor key again to re-enter the cursor menu.

Select Units

- To change the units of the horizontal position, press *H Unit*.

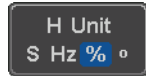

Units S, Hz, % (ratio), °(phase)

Phase or Ratio Reference

- To set the 0% and 100% ratio or the 0° and 360° phase references for the current cursor positions, press *Set Cursor Positions As 100%*.



Example

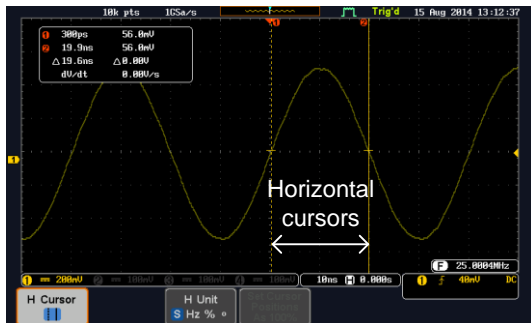

FFT

FFT cursors can use different units. For FFT details, see page 69.

1	1.0175GHz	21.2dB
2	2.2780GHz	-51.4dB
Δ	1.2525GHz	Δ72.6dB
d/dt		-58.0mD/Hz

- Cursor 1 Hor. position, dB/Voltage
- Cursor 2 Hor. Position, dB/Voltage
- Δ Delta (difference between cursors)
- dV/dt or d/dt

Example

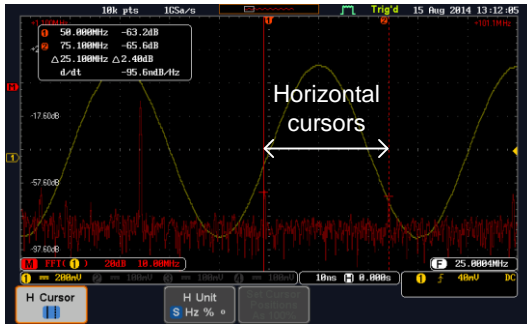

XY Mode

XY mode cursors measure a number of X by Y measurements. See page 82.

	1 (X)	2 (Y)	Δ
Versus			
t:	-625us	625us	1.25ms
Rectangular	x: 16.0U y: 1.76U	17.6U -1.44U	1.60U -3.20U
Polar	r: 16.0U θ: 6.27°	17.6U -4.67°	3.57U -63.4°
Product	x×y: 28.10U	-25.30U	-5.12U
Ratio	y÷x: 110mU/U	-81.8mU/U	-2.00U/U

- Cursor 1 Time, rectangular, polar coordinates, product, ratio.
- Cursor 2 Time, rectangular, polar coordinates, product, ratio.
- Δ Delta (difference between cursors)

Example

Horizontal cursors

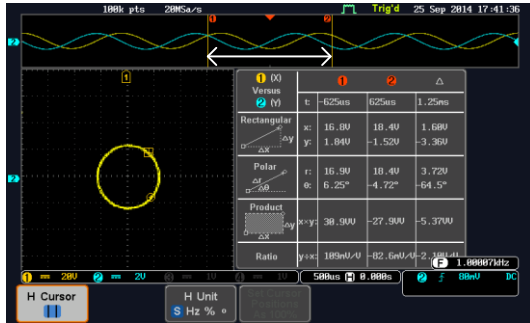

Use Vertical Cursors

Panel Operation/ Range 1. Press the *Cursor* key twice.



2. Press *V Cursor* from the bottom menu if it is not already selected.

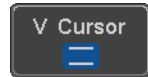

3. When the *V Cursor* is selected, repeatedly pressing the *V Cursor* key or the *Select* key will toggle which vertical cursor is selected.



Range

- ===== Upper cursor movable, lower cursor position fixed
- Lower cursor movable, upper cursor position fixed
- ===== Upper and lower cursor movable together

4. The cursor position information appears on the top left hand side of the screen.

□	25.100MHz	①	-7.20dB
○	50.100MHz	②	-62.0dB
△	25.000MHz	△	54.8dB
	d/dt		-2.19u dB/Hz

- , ○ Time: cursor 1, cursor 2
- ①, ② Voltage/Current: cursor1, cursor2
- △ Delta (difference between cursors)
- dV/dt or dI/dt

5. Use the *Variable* knob to move the cursor(s) up or down.



Select Units

6. To change the units of the vertical position, press *V Unit*.

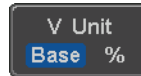

Units Base (source wave units), % (ratio)

Base or Ratio Reference

7. To set the 0% and 100% ratio references for the current cursor position, press *Set Cursor Positions As 100%*.



Example

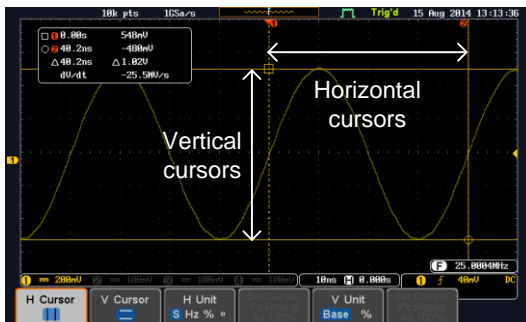

FFT

FFT has different content. For FFT details, see page 69.

□	25.100MHz	①	-7.20dB
○	58.100MHz	②	-62.0dB
△	25.000MHz	△	54.8dB
	d/dt		-2.19udB/Hz

- , ○ Frequency/Time: cursor1, cursor2
- ①, ② dB/V: cursor1, cursor2
- △ Delta (difference between cursors)
- d/dt

Example

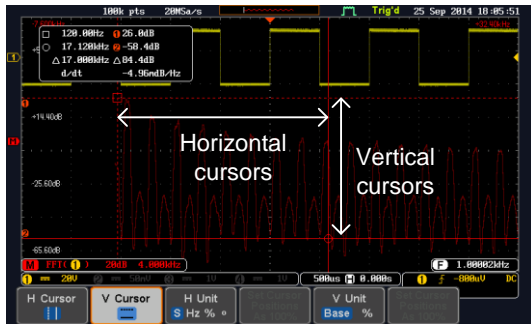

XY Mode

XY mode cursors measure a number of X by Y measurements. See page 82.

	①	②	△
① (X) Versus ② (Y)	t: -625us	625us	1.25ms
Rectangular 	x: 18.4U y: -1.44U	-14.4U -1.68U	-32.8U -240mV
Polar 	r: 18.4U θ: -4.47°	14.4U -173°	32.8U -179°
Product 	x×y: -26.40U	24.10U	7.870U
Ratio	y÷x: -78.2nU/U	116nU/U	7.31nU/U

- Cursor ① Rectangular, polar co-ordinates, product, ratio.
- Cursor ② Rectangular, polar co-ordinates, product, ratio.
- △ Delta (difference between cursors)

Example

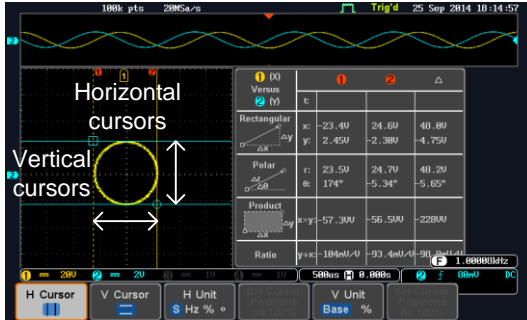

Math Operation

Basic Math Overview & Operators

Background	The Math function performs basic math functions (addition, subtraction, multiplication, division) on the input signals or the reference waveforms. The resultant waveform will be shown on the screen in real-time.
Addition (+)	Adds the amplitude of two signals. Source CH1~4, Ref1~4
Subtraction (-)	Extracts the amplitude difference between two signals. Source CH1~4, Ref1~4
Multiplication (×)	Multiplies the amplitude of two signals. Source CH1~4, Ref1~4
Division (÷)	Divides the amplitude of two signals. Source CH1~4, Ref1~4

Addition/Subtraction/Multiplication/Division

Panel Operation 1. Press the *Math* key.



2. Press the *Math* key on the lower bezel.

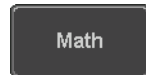

3. Select *Source 1* from the side menu



Range CH1~4, Ref1~4

- Press *Operator* to choose the math operation.

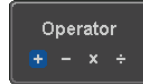

Range +, -, x, ÷

- Select *Source 2* from the side menu.



Range CH1~4, Ref1~4

- The math measurement result appears on the display. The vertical scale of the math waveform appears at the bottom of the screen.



From left: Math function, source1, operator, source2, Unit/div

Example

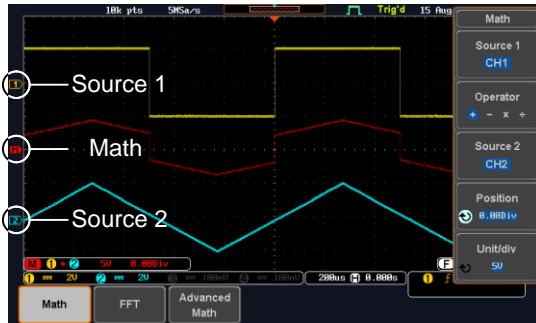

Position and Unit To move the math waveform vertically, press the *Position* key from the side menu and use the *Variable* knob to set the position.



Range -12.00 Div ~ +12.00 Div

To change the unit/div settings, press *Unit/div*, then use the *Variable* knob to change the unit/div.

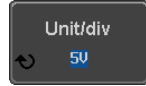

The units that are displayed depend on which operator has been selected, and whether the probe for the selected channel has been set to voltage or current.

Operator:	Unit/div:
Multiplication	VV, AA or W
Division	V/V, A/A
Addition/Subtraction	V or A

Turn Off Math To turn off the Math result from the display, press the *Math* key again.



FFT Overview & Window Functions

Background The FFT function performs a Fast Fourier Transform on one of the input signals or the reference waveforms. The resultant spectrum will be shown on the screen in real-time. Four types of window function are available: Hanning, Hamming, Rectangular, and Blackman, as described below.

Hanning

Frequency resolution	Good
Amplitude resolution	Not good
Suitable for...	Frequency measurement on periodic waveforms

Hamming	Frequency resolution	Good
	Amplitude resolution	Not good
	Suitable for...	Frequency measurement on periodic waveforms
Rectangular	Frequency resolution	Very good
	Amplitude resolution	Bad
	Suitable for...	Single-shot phenomenon (this mode is the same as having no window at all)
Blackman	Frequency resolution	Bad
	Amplitude resolution	Very good
	Suitable for...	Amplitude measurement on periodic waveforms



(Note)

For more complete measures and functions in the frequency domain of a signal, please also refer to the Spectrum Analyzer option of the MDO-2000EG on page 220.

FFT Operation

Panel Operation 1. Press the *Math* key.

MATH



2. Press *FFT* from the bottom menu.



3. Select the *Source* from the side menu.



Range CH1~4, Ref~4

- Press the *Vertical Units* key from the side menu to select the vertical units used.

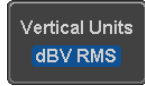

Range Linear RMS, dBV RMS

- Press the *Window* key from the side menu and select the window type.

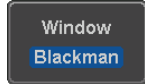

Range Hanning, Hamming, Rectangular, and Blackman.

- The FFT result represents the frequency-domain representation of a signal. Hence, the horizontal scale changes from time to frequency, and the vertical scale from voltage/current to dB/RMS.

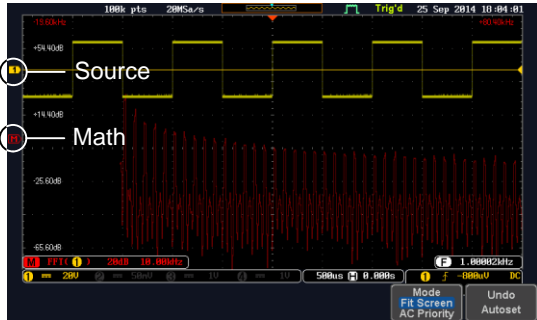

Position and Scale

To move the FFT waveform vertically, press *Vertical* until the *Div* parameter is highlighted and then use the Variable knob.

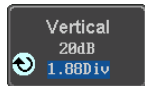

Range -12.00 Div ~ +12.00 Div

To select the vertical scale of the FFT waveform, press *Vertical* until the *dB* or *voltage* parameters are highlighted and then use the Variable knob.

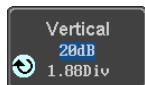

	Range	2mV~1kV RMS (Linear RMS), 1~20 dB (dB VRMS)
--	-------	--

Horizontal Position and Scale	To move the FFT waveform horizontally, press <i>Horizontal</i> until the <i>Frequency</i> parameter is highlighted and then use the Variable knob.	
-------------------------------	--	---

Range	0Hz ~ half of the sampling frequency
-------	--------------------------------------

To select the horizontal scale of the FFT waveform, press <i>Horizontal</i> repeatedly until the <i>Hz/div</i> parameter is highlighted and then use the Variable knob.	
---	---

Advanced Math Overview

Background	The advanced math function allows complex math expressions to be created based on the input sources, reference waveforms or even the automatic measurements available from the <i>Measure</i> menu (see page 46).
------------	---

An overview of each of the major parameters that can be used in the advanced math function are shown below:

Expression	Displays the function expression as it is created.
------------	--

Source	Selects the source signal.
Source	CH1~4, Ref1~4

Function	Adds a mathematical function to the expression.
Function	Intg, Diff, log, Ln, Exp, Sqrt, Abs, Rad, Deg, Sin, Cos, Tan, Asin, Acos, Atan

Variable	Adds a user-specified variable to the expression. Source CH1~4, Ref1~4
Operator	Adds an operator or parenthesis to the function expression. Operator +, -, *, /, (,), !(, <, >, <=, >=, ==, !=, , &&
Figure	Adds a value to the expression. Figure Integers, floating point, or floating point with exponent values.
Measurement	Adds automatic measurements to the expression. Not all automatic measurements are supported. Measurement Pk-Pk, Max, Min, Amp, High, Low, Mean, CycleMean, RMS, CycleRMS, Area, CycleArea, ROVShoot, FOVShoot, Freq, Period, Rise, Fall, PosWidth, NegWidth, Dutycycle, FRR, FRF, FFR, FFF, LRR, LRF, LFR, LFF, Phase, RPRFShoot, FPRESshoot, +Pulses, -Pulses, +Edges, -Edges

Advanced Math Operation

Panel Operation 1. Press the *Math* key.



2. Press *Advanced Math* from the bottom menu.

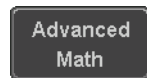

3. Press *Edit Expression*.

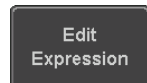

- The Edit $f(x)$ screen appears. CH1 + CH2 is shown in the expression box as an example at startup.

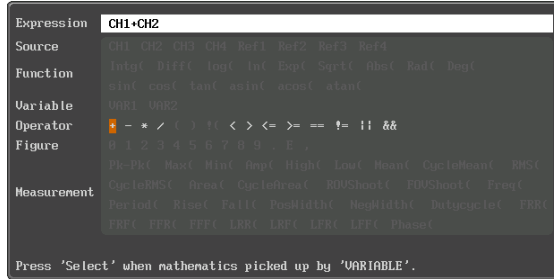

- Press *Clear* to clear the expression entry area.

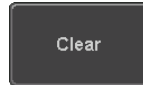

- Use the *Variable* knob and the *Select* key to create an expression.

Use the *Variable* knob to highlight a source, function, variable, operator, figure or measurement in orange.

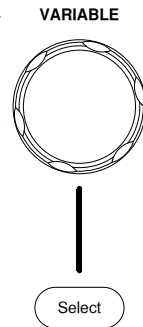

Press the *Select* key to make the selection.

If a particular parameter is grayed out, it indicates that the particular parameter is not available at that time.

Back Space

- To delete the last parameter press *Back Space*.



8. When the expression is complete, press *OK Accept*.

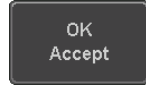

Example:
CH1 + CH2

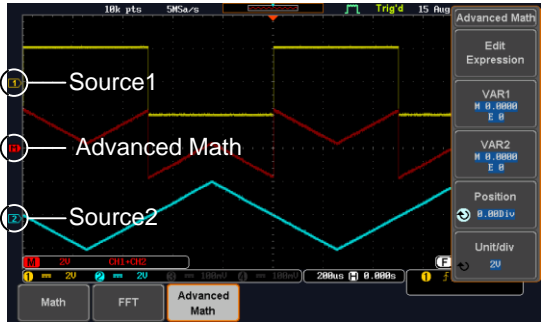

Set the VAR1 & VAR2

9. Press *VAR1* or *VAR2* to set VAR1/VAR2 if they were used in the expression created previously.

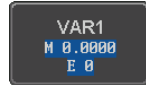

10. Press *Mantissa*.

Use the *Left* and *Right* arrow keys to select a digit and use the variable knob to set the value of the selected digit.



11. Press *Exponent*.

Use the Variable knob to set the exponent of the variable.

12. Press *Go Back* to finish editing VAR1 or VAR2.

Vertical Position and Scale

13. Press *Unit/div* and use the Variable knob to set the vertical scale of the math waveform.

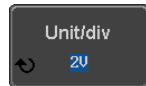

14. Press *Position* and use the Variable knob to set the vertical position of the math waveform on the display.



Clear Advanced Math

To clear the advanced math result from the display, press the *Math* key again.

MATH



ADVANCED CONFIGURATION

Acquisition	80
Select Acquisition Mode	80
Show Waveform in XY Mode	82
Set the Record Length	84
Segmented Memory Acquisition	85
Segments Display	87
Set the Number of Segments	87
Run Segmented Memory	88
Navigate Segmented Memory	90
Play Through Each Segment	91
Measurement on Segments	91
Segment Info	96
Display	97
Display Waveform as Dots or Vectors	97
Set the Level of Persistence	97
Set the Intensity Level	98
Select Display Graticule	99
Freeze the Waveform (Run/Stop)	100
Turn Off Menu	101
Horizontal View	102
Move Waveform Position Horizontally	102
Select Horizontal Scale	103
Select Waveform Update Mode	104
Zoom Waveform Horizontally	106
Play/Pause	108
Vertical View (Channel)	110
Move Waveform Position Vertically	110
Select Vertical Scale	111
Select Coupling Mode	111
Input Impedance	112
Invert Waveform Vertically	112

Limit Bandwidth.....	113
Expand by Ground/Center	114
Select Probe Type	115
Select Probe Attenuation Level	116
Set the Deskew	116
Bus Key Configuration	118
Bus Display	118
Serial Bus Overview.....	120
UART Serial Bus Configuration.....	122
I ² C Serial Bus Interface.....	124
SPI Serial Bus Interface	125
CAN Serial Bus Interface	127
LIN Serial Bus Interface	129
Bus Encoding.....	130
Threshold configuration	130
Serial Bus Event Tables	132
Event Tables Format.....	135
Adding a Label to a Bus.....	136
Using Cursors with the Serial Bus.....	138
Trigger	140
Trigger Type Overview	140
Trigger: types and sources	142
Trigger Parameter Overview	143
Setup Holdoff Level	148
Setup Trigger Mode	149
Using the Edge Trigger.....	149
Using Advanced Delay Trigger.....	151
Using Pulse Width Trigger	152
Using Video Trigger	154
Pulse Runt trigger.....	155
Using Rise and Fall Trigger	157
Using the Timeout Trigger	158
Using the Bus Trigger.....	160
UART BUS Trigger Settings.....	160
I ² C Bus Trigger Settings	161
SPI Bus Trigger Settings	164
CAN Bus Trigger.....	166
LIN Bus Trigger.....	169
Search	172
Configuring Search Events.....	172
Copying Search Event To/From Trigger Events	174
Search Event Navigation	174
Save Search Marks	175

Setting/Clearing Single Search Events.....	176
FFT Peak.....	177
System Settings and Miscellaneous Settings	181
Select Menu Language.....	181
View System Information.....	181
Erase Memory	182
Set Date and Time	183
Probe Compensation Frequency.....	184
QR Code Reader Function.....	184

Acquisition

The Acquisition process samples the analog input signals and converts them into digital format for internal processing.

Select Acquisition Mode

Background The acquisition mode determines how the samples are used to reconstruct a waveform.

Sample This is the default acquisition mode. Every sample from each acquisition is used.

Peak detect Only the minimum and maximum value pairs for each acquisition interval (bucket) are used. This mode is useful for catching abnormal glitches in the signal.

Average Multiple acquired data is averaged. This mode is useful for drawing a noise-free waveform. To select the average number, use the Variable knob.
Average number: 2, 4, 8, 16, 32, 64, 128, 256

Panel Operation 1. Press the *Acquire* key.



2. To set the Acquisition mode, press *Mode* on the bottom menu.



3. Select an acquisition mode from the side menu.

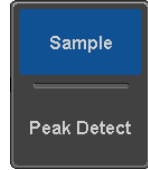

4. If *Average* was chosen, set the number of samples to be used for the average function.

Mode Sample, Peak Detect, Average



Average sample 2, 4, 8, 16, 32, 64, 128, 256

Example

Sample

Peak Detect

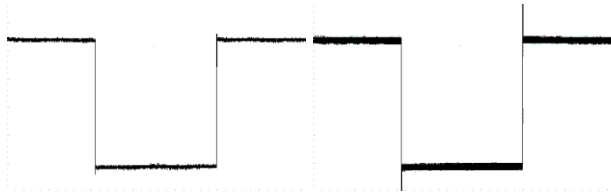

Average (256 times)

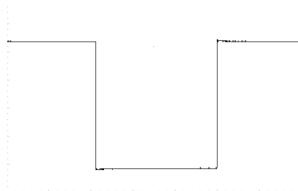



Show Waveform in XY Mode

Background The XY mode maps the input of channel 1 to the input of channel 2. In 4 channel models, the input of channel 3 can be mapped to the input of channel 4. This mode is useful for observing the phase relationship between waveforms.

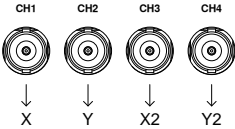
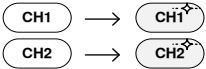
Connection

1. Connect the signals to Channel 1 (X-axis) and Channel 2 (Y-axis) or Channel 3 (X2-axis) and Channel 4 (Y2-axis).
 
2. Make sure a channel pair is active (CH1&CH2 or CH3&CH4). Press the Channel key if necessary. A channel is active if the channel key is lit.
 

Panel Operation

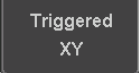
3. Press the *Acquire* menu key.
 
4. Press XY from the bottom menu.
 
5. Choose *Triggered XY* from the side menu.
 

X-Y mode is split into two windows. The top window shows the signals over the full time range. The bottom window shows XY mode.

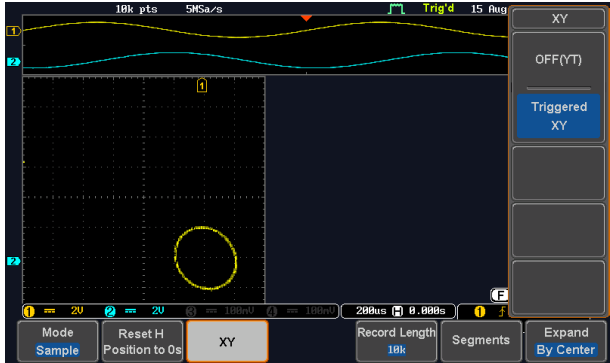

To move the XY waveform position, use the vertical position knob: Channel 1 knob moves the XY waveform horizontally and Channel 2 knob moves the XY waveform vertically. Similarly, the X2 and Y2 axis can be positioned using the channel 3 and channel 4 vertical position knobs.

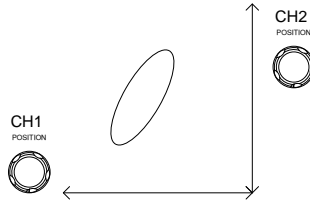

The horizontal position knob and horizontal Scale knob can still be used under the XY mode.

Turn Off XY Mode To turn off XY mode, choose OFF (YT) mode.



Cursors and XY Mode

Cursors can be used with XY mode. See the Cursor chapter for details.

Page 60

Set the Record Length

Background The number of samples that can be stored is set by the record length. Record length is important in an oscilloscope as it allows longer waveforms to be recorded.

The maximum record length for the MDO-2000EG/2000EX depends on operating mode. The table below describes the record lengths that are available for each mode.

Limitations

Record Length	Normal	Zoom	FFT	FFT in Zoom Window
1k	✓	✗	✓	✗
10k	✓	✓	✓	✓
100k	✓	✓	✓	✓
1M	✓	✓	✓	✗
10M	✓	✓	✗	✗

Panel Operation 1. Press the *Acquire* key.



2. Press the *Record Length* key on the bottom menu and choose the record length.

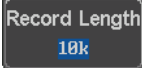

Record length 1000, 10k, 100k, 1M, 10M points



Note

The sampling rate may also be changed when the record length is changed.

Segmented Memory Acquisition

The advanced segmented memory utility allows the scope memory to be divided into different segments. Each time the scope is triggered, it only acquires data for one segment of memory at a time. This allows you to optimize the scope memory to only perform signal acquisition during important signal events.

For example, for a signal with a number of pulses, normally the oscilloscope will acquire the signal until the acquisition memory of the scope is filled up and then it will re-arm the trigger and then capture again. This could result in a number of events not being captured or captured at a less-than-desired resolution (depending on the horizontal scale and sampling rate). However, the segmented memory function would effectively allow you to capture more of the signal than you would otherwise. The diagrams below illustrate this point.

Normal acquisition mode example:

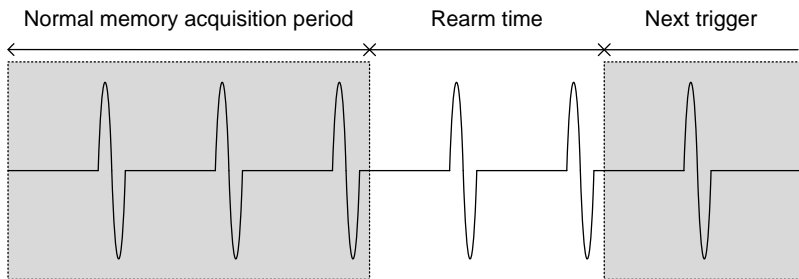

Segmented memory acquisition example:

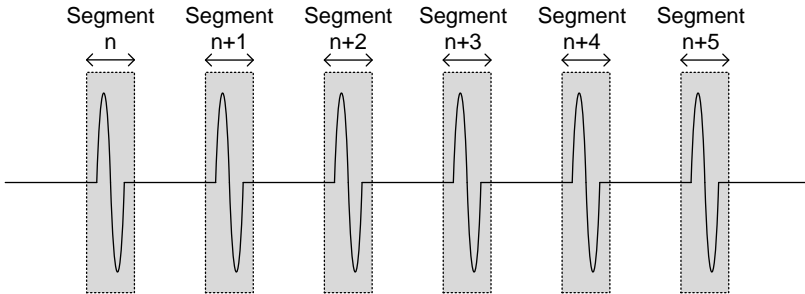

As shown above, the memory is divided into segments to increase the number of events that can be effectively captured with the same acquisition memory. Also notice that the scope doesn't need to rearm the trigger between each segment, this makes the segmented memory function especially useful for high speed signals. The time between each segment is also recorded so that accurate signal timing can also be measured.

The segmented memory function also supports automatic measurements for each segment or statistics for all the captured segments.

Segments Display

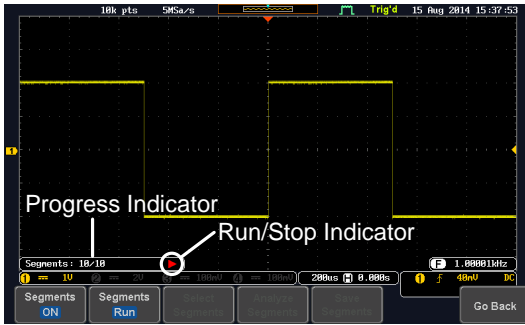

Progress Indicator



Indicates the number of segments that have to be captured relative to the set number of segments.

Run/Stop Indicator



Stop: The segments have finished acquiring or have been stopped.



Run: The scope is ready to acquire segments.

Set the Number of Segments

Note

Before the Segment function can be used, set the trigger settings as appropriate for the signal you wish to use. The number of segments that can be used depends wholly on the record length. See page 84 to set the record length.

Record length	Number of segments
1000 pt.	1 ~ 29000
10k pt.	1 ~ 2900
100k pt.	1 ~ 290
1M pt.	1 ~ 20

10M pt.

1 ~ 2

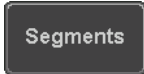
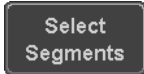
- Panel Operation
1. Press the *Acquire* key. 
 2. Press *Segments* on the bottom menu. 
 3. Press *Select Segments* and set the number of segments from the side menu. 

Num of Seg	1~29000 (record length dependant)
Set to Maximum	Sets to the maximum number
Set to Minimum	Sets to 1 segment



Note

The Select Segments icon is only available when Segments = OFF or when Segments is in the STOP mode (see the section below).

Run Segmented Memory

Background Before the Segmented Memory function can be used, set the trigger settings as appropriate for the signal you wish to use. See page 140 for configuring the trigger settings.

- Run Segments**
1. Toggle *Segments On* from the bottom menu.



Note

The first time Segmented memory is turned on the segments will automatically be run. Each segment will be automatically captured.

2. The scope will automatically start acquiring segments. The progress of the segmented memory capture is shown in the Progress Indicator.
3. The Run Indicator will be shown in the Run mode and the Segments icon will also indicate that the function is in run mode.

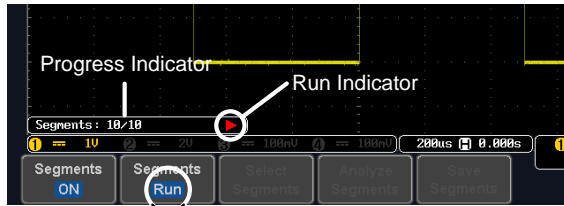

Segment (Run) icon

4. When the scope has finished acquiring segments, press *Segments Run* to toggle the mode to the *Segments Stop* mode.



Alternatively, the *Run/Stop* key can be pressed. Run/Stop

5. The Stop Indicator will be shown when in the Stop mode.

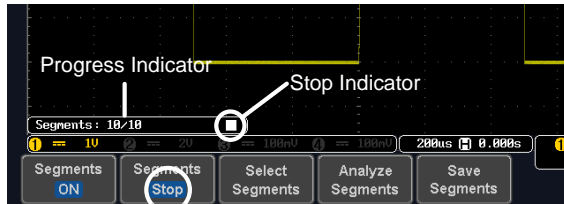

Segment (Stop) icon

The scope is now ready to navigate or analyze the acquired segments.

- Rerun Segmented Acquisition 6. To rerun the segments, press the *Segments Stop* key to toggle the mode back to the *Segments Run* mode.



Alternatively, press the *Run/Stop* key again.

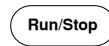

7. Repeat steps 3 and 4 in the section above when the segmented acquisition has completed.

Navigate Segmented Memory

Background

After the segmented memory acquisitions have been captured you can navigate through each segment one at a time.

Operation

1. Press *Select Segments* from the bottom menu. This key will be available in the Stop mode.
2. To navigate to the segment of interest, press *Current Seg* from the side menu and use the Variable knob to scroll to the segment of interest.

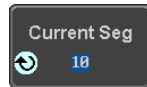
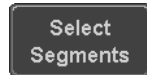

Alternatively, the *Set to Minimum* and *Set to Maximum* keys can be used to jump to the first and last segment respectively.

3. The position in time of the selected segment relative to the time of the first segment is shown in the *Segments Time* key.

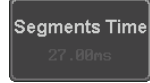

Play Through Each Segment

Background When all the segments have been acquired, the play/pause key can be used to play back through each segment.

- Operation**
1. Make sure the scope is in *Segments Stop* mode. See page 88 for details.
 2. Press the *Play/Pause* key to run through the acquired segments in numerical order.
 - Press the Play/Pause key again to pause the playback.
 - When the scope has played through to the last segment, pressing the Play/Pause key again will play through each segment again in reverse order.



Measurement on Segments

Background The Segmented memory function can be used in conjunction with the automatic measurements configured in the Measurement menu (see page 46).

Modes	Segments Measure	This function will either perform statistics calculations on the segments or tabulate a list of the measurement results for all the segments.
	Segments Info	Provides configuration information common for all the acquired memory segments.

Segments Measure

The Segments Measure function allows you to view automatic measurements for the segments in statistical bins or as a list displaying the result of each automatic measurement.

Statistics

This function will bin the measurement results of a single automatic measurement into a user-defined number of bins. This allows you to easily view statistics for a large number of segments. For example, the statistics function will display the number of results for each bin and the measurement range of each bin for the selected automatic measurement.

Measurement List

Puts all the measurement results for a segment in a list. All the currently selected automatic measurement results are listed. A maximum of 8 automatic measurements can be used with this function.



Note

To use automatic measurements with the segmented memory, automatic measurements must first be selected from the Measure menu before the segmented memory function is run.

Setup

Press the *Measure* key and select any *single* source measurement from the *Add Measurement* menu.



See page 50 for details on how to add automatic measurements.

Operation

1. Press *Analyze Segments* from the Segments menu.



Note: This key will only be available in the Stop mode.

2. Press *Segments Measure*.



3. Select either the statistics or the measurement list from the side menu.





Statistics





List

4. The statics table or measurement list appears on the display.

Note that the more segments that you have, the longer it will take to calculate the statics or list the measurement results.

5. For statistic measurements, press *Plot Source* to choose which automatic measurement to use for the statistics calculations. The statistics for only one automatic measurement can be viewed at a time.
- 
6. For the measurement list, press *Source* and select the source channel for measurement.
- 
- Range CH1 ~ CH4

Statistics Results This function will bin the measurement results of the selected automatic measurement into a user-defined number of bins.

- Setup**
7. To select the number of bins for the statistics, press *Divided by* and select the number of bins with the Variable knob.
- 
- Range 1~20 bins
8. Press *Select* and use the Variable knob to view the measurement results for each bin.
- 

Example:
Statistics

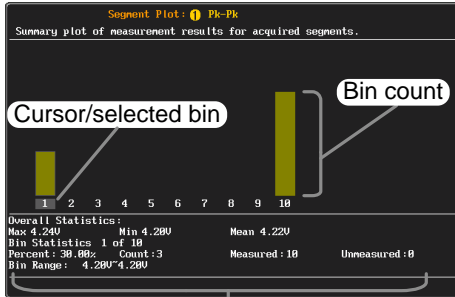

Statistics of currently selected bin

Measurement List

Puts all the measurement results for a segment in a list.

Setup

9. Press *Select* and use the variable knob to scroll through each segment.



Example:
Measurement List

Select cursor

Seg.	Fall PreShoot (%)	Rise PreShoot (%)	Pk-Pk (u)
1	0.00	0.97	4.24
2	0.00	0.97	4.20
3	0.00	0.97	4.24
4	0.00	0.97	4.24
5	0.00	0.97	4.20
6	0.00	0.97	4.24
7	0.00	0.97	4.20
8	0.00	0.97	4.24
9	0.00	0.97	4.24
10	0.00	0.97	4.24

Segment Info

Operation

1. Press *Analyze Segments* from the bottom menu.

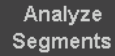

Note: This key will only be available in the Stop mode.

2. Press *Segments Info*.

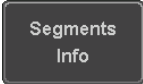

3. A table showing all general setting information for the segmented memory acquisitions is shown on the display.

Info: Sample rate, Record length,
Horizontal, Vertical

DSD Segmented Info.

```

Samplerate: 1GSa/s
Record Length: 1000 points
Horizontal: 0.000s @ 200ns/div
Vertical: 1 80.000mV @ 1V/div
  
```



Display

The Display menu defines how the waveforms and parameters appear on the main LCD display.

Display Waveform as Dots or Vectors

Background When the waveform is displayed on the screen, it can be displayed as dots or vectors.

Panel Operation

1. Press the *Display* menu key. 
2. Press *Dot / Vector* to toggle between Dot and Vector mode. 

Range	Dots	Only the sampled dots are displayed.
	Vectors	Both the sampled dots and the connecting line are displayed.



Set the Level of Persistence

Background The persistence function allows the MDO-2000EG/2000EX to mimic the trace of a traditional analog oscilloscope. A waveform trace can be configured to “persist” for a designated amount of time.

Panel Operation 1. Press the *Display* menu key. 

- To set the persistence time, press the *Persistence* menu button on the bottom bezel.

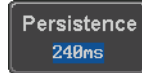

- Use the Variable knob to select a persistence time.

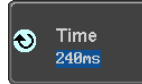

Time 16ms, 30ms, 60ms, 120ms, 240ms,
0.5s, 1s, 2s, ~4s, Infinite, Off

Clear To clear persistence, press *Clear Persistence*.

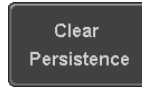

Set the Intensity Level

Background The intensity level of a signal can also be set to mimic the intensity of an analog oscilloscope by setting the digital intensity level.

Panel Operation 1. Press the *Display* menu key.

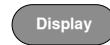

- Press *Intensity* from the bottom menu.



Waveform Intensity 3. To set the waveform intensity, press *Waveform Intensity* and edit the intensity.

Range 0~100%

Example Waveform Intensity 50% Waveform Intensity 100%

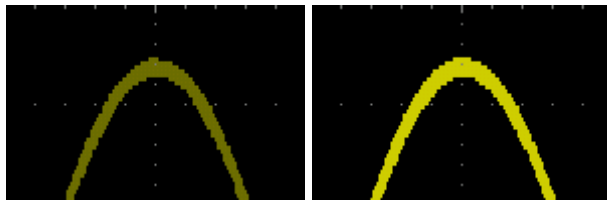

Graticule Intensity 4. To set the graticule intensity, press *Graticule Intensity* from the side menu and edit the intensity value.

Range 10~100%

Example Graticule Intensity 100% Graticule Intensity 10%



Backlight Intensity 5. To set the LCD backlight intensity, press *Backlight Intensity* from the side menu and edit the intensity value.

Range 2~100%

Backlight Auto-Dim 6. To automatically dim the backlight after a set duration, set *Backlight Auto-Dim* to On and then set *Time* to the appropriate time.

After the set amount of time with no panel activity, the screen will dim until a panel key is pressed again. This function will prolong the life of the LCD display.

Range 1~180 min

Select Display Graticule

Panel Operation 1. Press the *Display* menu key.



2. Press *Graticule* from the bottom menu.



- From the side menu choose the graticule display type.



Full: Shows the full grid; X and Y axis for each division.



Grid: Show the full grid without the X and Y axis.





Cross Hair: Shows only the center X and Y frame.







Frame: Shows only the outer frame.

Freeze the Waveform (Run/Stop)

For more details about Run/Stop mode, see page 42.

- Panel Operation
- Press the *Run/Stop* key. The *Run/Stop* key turns red and waveform acquisition is paused.
  → 
 - The waveform and the trigger freezes. The trigger indicator on the top right of the display shows Stop.
 



 - To unfreeze the waveform, press the *Run/Stop* key again. The *Run/Stop* key turns green again and acquisition resumes.
  → 

Turn Off Menu

- Panel Operation
1. Press the *Menu Off* key below the side menu keys to reduce a menu. The menu key needs to be pressed each time to reduce one menu.

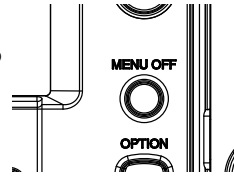

See page 32 for more information.

Horizontal View

This section describes how to set the horizontal scale, position, and waveform display mode.

Move Waveform Position Horizontally

Panel Operation The horizontal position knob moves the waveform left/right.

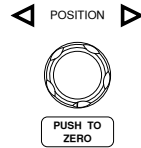

As the waveform moves, a position indicator on the top of the display indicates the horizontal position of the waveform in memory.

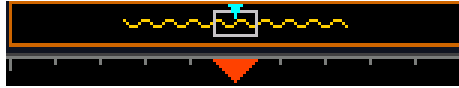

Reset Horizontal Position

- To reset the horizontal position, press the Acquire key and then press *Reset H Position to 0s* from the bottom menu.

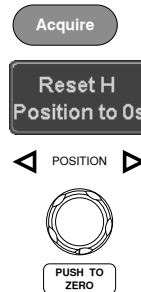

Alternatively, pushing the horizontal position knob will also reset the position to zero.

Run Mode In Run mode, the memory bar keeps its relative position in the memory since the entire memory is continuously captured and updated.

Select Horizontal Scale

Select Horizontal Scale To select the timebase (time/div), turn the horizontal Scale knob; left (slow) or right (fast).

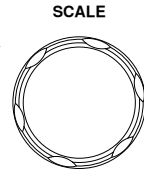

Range 1ns/div ~ 100s/div, 1-2-5 increment

The timebase indicator updates as the horizontal scale is adjusted.

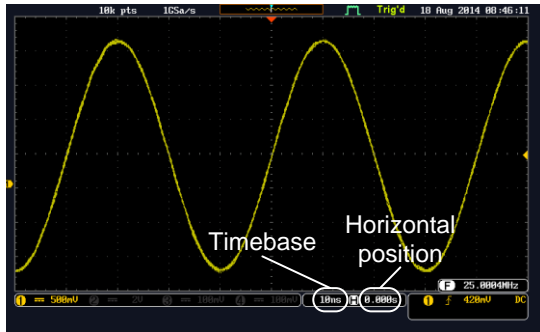

Run Mode In Run mode, the memory bar and waveform size keep their proportion. When the timebase becomes slower, roll mode is activated (if the trigger is set to Auto).

Stop Mode In Stop mode, the waveform size changes according to the scale.

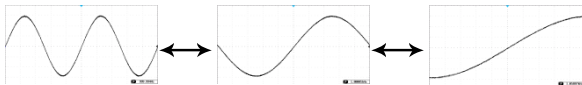

Select Waveform Update Mode

Background	The display update mode is switched automatically or manually according to the timebase and trigger.	
Normal	Updates the whole displayed waveform at once. Automatically selected when the timebase (sampling rate) is fast. Timebase $\leq 50\text{ms/div}$ Trigger all modes	
Roll Mode	Roll	Updates and moves the waveform gradually from the right side of the display to the left. Automatically selected when the timebase (sampling rate) is slow. Timebase $\geq 100\text{ms/div}$ Trigger all modes



Select Update Mode Manually

1. Press the Trigger *Menu* key.



2. Press *Mode Auto/Normal* key from the bottom menu to let the equipment choose between Auto (Untriggered Roll) and Normal mode.

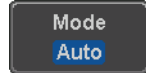

The auto (Untriggered Roll) trigger mode enables free-running and roll mode (timebase $\geq 100\text{ms/div}$) acquisitions.

The normal trigger mode enables the equipment which trigger only on valid trigger events. If no trigger occurs, the last waveform record acquired remains on the display. If no last waveform exists, no waveform is displayed

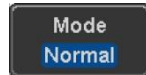

User can also force the equipment to trigger. To do so, press the *Force-Trig* key on the front panel.



Zoom Waveform Horizontally

Background When in *Zoom* mode, the screen is split into 2 sections. The top of the display shows the full record length, while the bottom of the screen shows the normal view.

Panel Operation 1. Press the *Zoom* key.

Zoom

2. The *Zoom* mode screen appears.

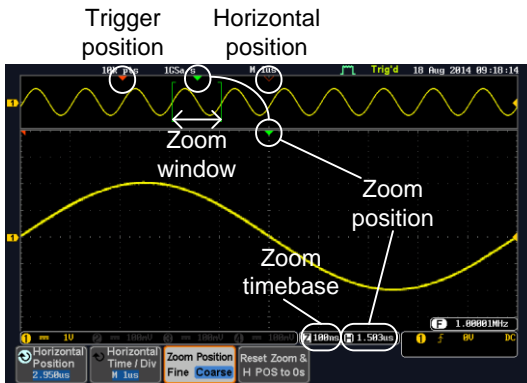

Horizontal Navigation

To scroll the waveform left or right, press *Horizontal Position* and use the *Variable Position* knob.



The horizontal position will be shown on the *Horizontal Position* icon.

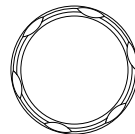

Horizontal Scale To change the horizontal scale, press *Horizontal Time/Div* and use the *Variable Position* knob.

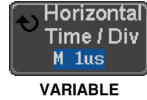

The scale will be shown on the *Horizontal Time/Div* icon.

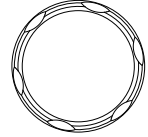

Zoom To increase the zoom range, use the horizontal *Scale* knob.

SCALE

The zoom time base (Z) at the bottom of the screen will change accordingly.

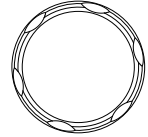

Move the Zoom Window Use the *Horizontal Position* knob to pan the zoom window horizontally.

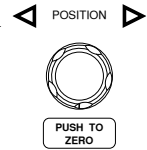

To reset the zoom position, press the *Horizontal Position* knob.

The position of the zoom window, relative to the horizontal position is shown at the bottom of the screen next to the Zoom timebase.





Scroll Sensitivity To alter the scrolling sensitivity of the zoom window, press the *Zoom Position* key to toggle the scrolling sensitivity.

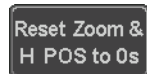

Sensitivity Fine, Coarse

Reset the Zoom & Horizontal Position To reset both the zoom and horizontal position, press *Reset Zoom & H POS to 0s*.



Exit To go back to the original view, press  the *Zoom* key again.

Play/Pause

Background The Play/Pause key can be used to play through signals in the Zoom mode.

Note If the Segmented memory function is turned on, pressing the play pause key will play through memory segments. See page 91 for more information.

Panel Operation 1. Press the *Play/Pause* menu key. 

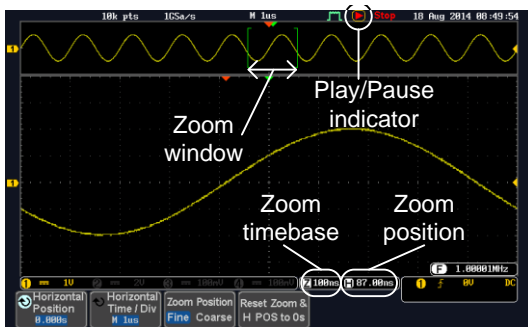

2. The scope will go into the Zoom Play mode and begin to scroll through the acquisition (from left to right).

The full-record length waveform will be shown at the top and the zoomed section will be shown at the bottom. The Play/Pause indicator shows the play status.

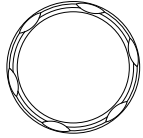

Zoom To increase the zoom range, use the horizontal *Scale* knob.

The zoom time base (Z) at the bottom of the screen will change accordingly.





Scroll Speed To alter the scrolling speed of the zoom window, press the *Zoom Position* key to toggle the scrolling speed.

Sensitivity Fine, Coarse

Alternatively, use the horizontal position knob to control the scroll speed.

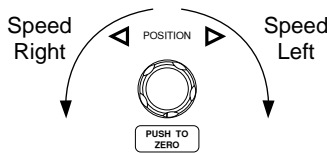
- Turning the Horizontal knob determines the speed and direction of the scrolling.



Reset the Zoom Position To reset both the zoom position and horizontal position, press *Reset Zoom & H POS to 0s*.

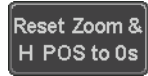

Pause Press the *Play/Pause* key to pause or resume playing the waveform.



Reverse Direction Press the *Play/Pause* key when at the end of the record length to play back through the waveform in reverse.



Exit To exit, press the *Zoom* key.



Vertical View (Channel)

This section describes how to set the vertical scale, position, and coupling mode.

Move Waveform Position Vertically

- Panel Operation
1. To move the waveform up or down, turn the *vertical position* knob for each channel.

POSITION







PUSH TO ZERO

2. As the waveform moves, the vertical position of the channel indicator appears at the bottom half of the display.

Position = 0.00U

View or Set the Vertical Position

3. Press a channel key. The vertical position is shown in the  *Position /*  *Set to 0* soft key.
4. To change the position, press  *Position /*  *Set to 0* to reset the vertical position or turn the *vertical position* knob to the desired level.

CH1



POSITION



PUSH TO ZERO

- Run/Stop Mode
- The waveform can be moved vertically in both Run and Stop mode.

Select Vertical Scale

Panel Operation To change the vertical scale, turn the vertical SCALE knob; left (down) or right (up).

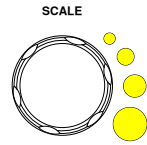

The vertical scale indicator on the bottom left of the display changes accordingly for the specific channel.



Range 1mV/div ~ 10V/div. 1-2-5 increments

Stop Mode In Stop mode, the vertical scale setting can be changed.

Select Coupling Mode

Panel Operation 1. Press a *channel key*.



2. Press *Coupling* repeatedly to toggle the coupling mode for the chosen channel.



Range

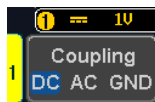

DC coupling mode. The whole portion (AC and DC) of the signal appears on the display.

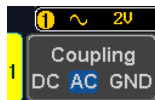

AC coupling mode. Only the AC portion of the signal appears on the display. This mode is useful for observing AC waveforms mixed with DC signals.

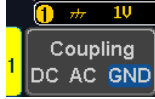

Ground coupling mode. The display shows only the zero voltage level as a horizontal line.

Example

Observing the AC portion of the waveform using AC coupling

DC coupling

AC coupling



Input Impedance

Background

The input impedance of the MDO-2000EG/2000EX is fixed at 1MΩ. The impedance is displayed in the channel menu.

View Impedance 1. Press the *Channel* key.



2. The impedance is displayed in the bottom menu.



Invert Waveform Vertically

Panel Operation 1. Press the *Channel* key.



2. Press *Invert* to toggle Invert On or Off.

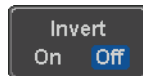



Limit Bandwidth

Background Bandwidth limitation puts the input signal into a selected bandwidth filter.

This function is useful for cutting out high frequency noise to see a clear waveform shape.

The bandwidth filters available are dependent on the bandwidth of the oscilloscope model.

Also refer to the digital filter application, page 265.

- Panel Operation**
1. Press the *Channel* key. 
 2. Press *Bandwidth* from the bottom menu. 
 3. Choose a bandwidth* from the side menu.
*Depending on the bandwidth of the oscilloscope.
- Range 70MHz models: Full, 20MHz
 100MHz models: Full, 20MHz
 200MHz models: Full, 20MHz, 100MHz

Example

BW Full

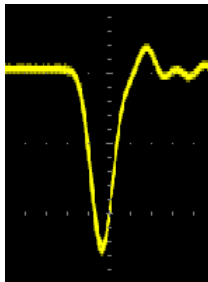

BW Limit 20MHz

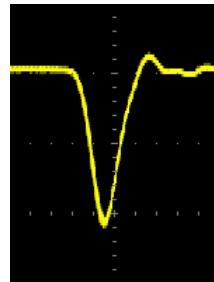

Expand by Ground/Center

Background When the voltage scale is changed, the Expand function designates whether the signal expands from the center of the screen or from the signal ground level. Expand by center can be used to easily see if a signal has a voltage bias. Expand by ground is the default setting.

Panel Operation 1. Press a *channel* key.



2. Press *Expand* repeatedly to toggle between expand *By Ground* and *Center*.



Range By Ground, By Center

Example If the vertical scale is changed when the Expand function is set to ground, the signal will expand from the ground level*. The ground level does not change when the vertical scale is changed.

If the vertical scale is changed when the Expand function is set to center, the signal will expand from the center of the screen. The ground level will suit to match the signal position.

*Or from the upper or lower edge of the screen if the ground level is off-screen.

Expand by Ground

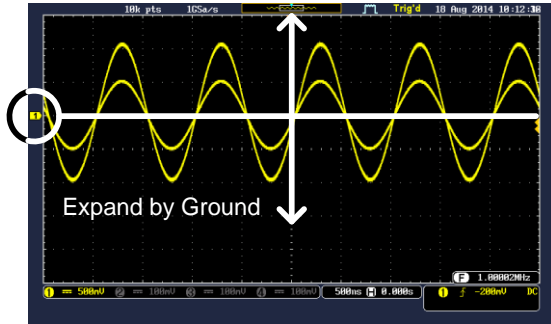

Expand by Center

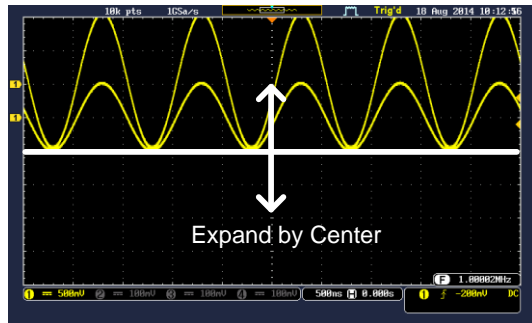

Select Probe Type

Background A signal probe can be set to voltage or current.

Panel Operation

1. Press the *Channel* key.
2. Press *Probe* from the bottom menu.
3. Press the *Voltage/Current* soft-key to toggle between voltage and current.

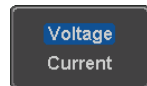
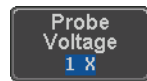

Select Probe Attenuation Level

Background An oscilloscope probe has an attenuation switch to lower the original DUT signal level to the oscilloscope input range, if necessary. The probe attenuation selection adjusts the vertical scale so that the voltage level on the display reflects the real value on a DUT.

Panel Operation 1. Press the *Channel* key.



2. Press *Probe* from the bottom menu.



3. Press *Attenuation* on the side menu and use the Variable knob to set the attenuation.

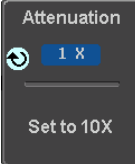

Alternatively, press *Set to 10X*.

Range 1mX ~1kX (1-2-5 step)



Note

The attenuation factor adds no influence on the real signal. It just changes the voltage/current scale on the display.

Set the Deskew

Background The deskew function is used to compensate for the propagation delay between the oscilloscope and the probe.

Panel Operation 1. Press one of the *Channel* keys.



2. Press *Probe* from the bottom menu.



3. Press *Deskew* on the side menu and use the Variable knob to set the deskew time.

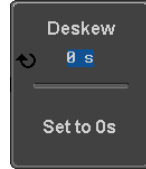

Alternatively, press *Set to 0s* to reset the deskew time.

Range -50ns~50ns, 10ps increments

4. Repeat the procedure for another channel if necessary.

Bus Key Configuration

The Bus key is used to configure the Serial bus inputs. The Bus menu also features event tables to track and save your bus data. The Bus key is used in conjunction with the Bus trigger (page 160) to decode serial bus signals.

Bus Display

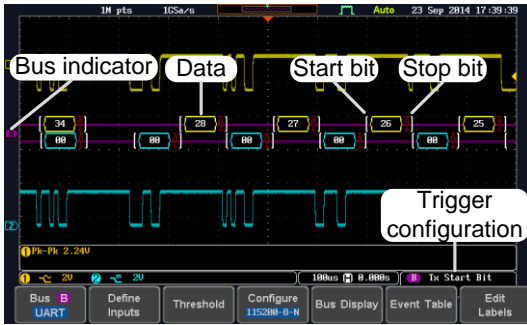

- Start Bit/Start of Frame [The Start bit is shown as an open bracket (Serial bus data only).
- Stop Bit/End of Frame] The Stop bit is shown as a closed bracket (Serial bus data only).
- Data . F9 . Data packets/frames/words can be shown in Hex or Binary. The color of the bus data indicates the type of data or the channel the data is coming from, depending on the bus type.
- UART: Color of packet = Color of source channel.
- I²C: Color packet = SDA source channel.
- SPI: Color of packet = MOSI or MISO source channel.

CAN: Purple = Error frame, Data length control (DLC), Overload.
 Yellow = Identifier.
 Cyan = Data.
 Orange = CRC.
 Red = Bit stuffing error

LIN: Purple = Break, Sync and Checksum errors, Wakeup
 Yellow = Identifier, Parity
 Cyan = Data
 Red = Error type

Error Indicator/ Missing Ack  If there is an error/missing acknowledgement in decoding the data, a red error indicator will be shown.

Bus Indicator The Bus indicator shows the bus position. The active bus is shown with a solid color. The Variable knob can be used to horizontally position the Bus indicator when it is active.

 Active bus (solid indicator)  Activated bus (transparent indicator)

Trigger Configuration Shows the bus trigger (B) and the *Trigger On* settings. Please see page 160.

 **B** Tx Start Bit

Serial Bus Overview

The Serial Bus includes support for 5 common serial interfaces UART, I²C, SPI, CAN and LIN. Each interface is fully configurable to accommodate variations in the basic protocols.

Each input can be displayed as binary, hexadecimal or ASCII. An event table can also be created to aid in debugging.

UART	<p>Universal Asynchronous Receiver Transmitter. The UART bus is able to accommodate a wide range of various common UART serial communications.</p> <p>The UART serial bus software is suitable for a number of RS-232 protocol variants.</p>
Inputs	Tx, Rx
Threshold	Tx, Rx
Configuration	Baud rate, Parity, Packets, End of packets, Input polarity
Trigger On	Tx Start Bit, Rx Start Bit, Tx End of Packet, Rx End of Packet, Tx Data, Rx Data, Tx Parity Error, Rx Parity Error

I ² C	<p>Inter Integrated Circuit is a two line serial data interface with a serial data line (SDA) and serial clock line (SCLK). The R/W bit can be configured.</p>
Inputs	SCLK, SDA
Threshold	SCLK, SDA
Configuration	Addressing mode, Read/Write in address
Trigger On	Start, Repeat Start, Stop, Missing Ack, Address, Data, Address/Data

SPI	<p>The SPI (Serial Interface Peripheral) bus is fully configurable to accommodate the wide variety of SPI interfaces. This bus is only available on 4 channel models.</p>
Inputs	SCLK, SS, MOSI, MISO
Threshold	SCLK, SS, MOSI, MISO
Configuration	SCLK edge, SS logic level, Word size, Bit order
Trigger On	SS Active, MOSI, MISO, MOSI&MISO
CAN	<p>The CAN (Controller Area Network) bus is a 2-wire, message-based protocol.</p>
Inputs	CAN Input
Threshold	CAN Input
Configuration	Signal Type, Bit Rate
Trigger On	Start of Frame, Type of Frame, Identifier, Data, Id & Data, End of Frame, Missing Ack, Bit Stuffing Err.
LIN	<p>The LIN (Local Interconnect Network) bus is used to decode a wide range of common LIN configurations.</p>
Inputs	LIN Input
Threshold	LIN Input
Configuration	Bit Rate, LIN Standard, Include Parity Bits with Id
Trigger On	Sync, Identifier, Data, Id & Data, Wakeup Frame, Sleep Frame, Error

UART Serial Bus Configuration

The UART bus menu is designed to decode RS-232 and other common RS-232 variants such as RS-422, RS-485. The software configuration is also flexible enough to decode the many proprietary protocols based on RS-232.

Background

Basic RS-232 protocol uses single-ended data transmissions. The signal voltage levels can be high ($\pm 15V$) and employ active low signaling.

High speed variants of RS-232, such as RS-422 and RS-485 use differential signaling and commonly employ low voltage differential signals with active high signaling.

Universal Asynchronous Receiver/Transmitter (UART) or RS-232 driver/receiver ICs commonly used for embedded applications typically use active high signaling with standard IC signal levels.

Operation

1. Connect each of the bus signals (*Tx*, *Rx*) to one of the oscilloscope's analog channels. Connect the ground potential of the bus to one of the probes' ground clip if you are using the analog channels.

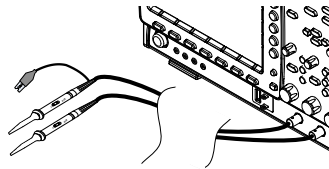
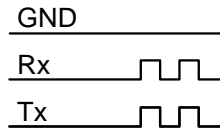

2. Press the *BUS* key.

BUS



3. Press *Bus* from the bottom menu and choose the *UART* serial bus on the side menu.

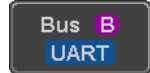

4. Press either *Analog Source* to choose the sources for the UART bus is analog.



Define Inputs

5. Press *Define Inputs* from the bottom menu.



6. From the side menu choose the *Tx Input* and the *Rx Input* source and the signal polarity.

Tx OFF, CH1~CH4 or OFF

Rx OFF, CH1~CH4 or OFF

Polarity Normal (High = 0), Inverted (High = 1)

Configuration

The Configure key sets the baud rate, number of data bits and parity.

7. Press *Configure* from the bottom menu.



8. From the side menu select the *Baud rate*, *Data bits*, *Parity*, *Packets* and *End of Packet bits*.

Baud Rate 50, 75, 110, 134, 150, 300, 600, 1200, 1800, 2000, 2400, 3600, 4800, 7200, 9600, 14400, 15200, 19200, 28800, 31250, 38400, 56000, 57600, 76800, 115200, 128000, 230400, 460800, 921600, 1382400, 1843200, 2764800

Data Bits 8 (fixed)

Parity	Odd, Even, None
Packets	On, Off
End of Packet (Hex)	00(NUL), 0A(LF), 0D(CR), 20(SP), FF

I²C Serial Bus Interface

The I²C bus is a 2 wire interface with a serial data line (SDA) and serial clock line (SCLK). The I²C protocol supports 7 or 10 bit addressing and multiple masters. The scope will trigger on any of the following conditions: a start/stop condition, a restart, a missing acknowledge message, Address, Data or Address & Data frames. The I²C trigger can be configured for 7 or 10 bit addressing with the option to ignore the R/W bit as well as triggering on a data value or a specific address and direction (read or write or both).

- Panel operation
1. Connect each of the bus signals (*SCLK*, *SDA*) to one of the oscilloscope's analog channels. Connect the ground potential to one of the probes' ground clip if you are using the analog channels.

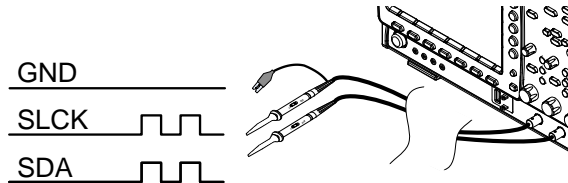

2. Press the *Bus* key.



3. Press *Bus* from the bottom menu and choose *I²C* from the side menu.

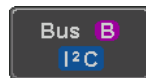

4. Press *Analog Source* to choose the sources for the I²C bus is.



Define Inputs

5. Press *Define Inputs* from the bottom menu.

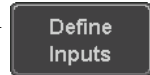

6. From the side menu choose the *SCLK* input and the *SDA* Input.

SCLK CH1~CH4

SDA CH1~CH4

Include R/W in address

To configure whether you want the R/W bit to be included in the address, press *Include R/W in address* and set to Yes or No in the side menu.



R/W Bit Yes, No

SPI Serial Bus Interface

The serial peripheral interface (SPI) is a full duplex 4 wire synchronous serial interface. The 4 signals lines: Serial clock line (SCLK), slave select (SS), Master output/slave input (MOSI, or SIMO) and the Master input/slave output (MISO, or SOMI). The word size is configurable from 4 to 32 bits. The SPI triggers on the data pattern at the start of each framing period. Note: The SPI bus with analog source is only available for 4 channel models.

Panel operation

1. Connect each of the bus signals (*SCLK*, *SS*, *MOSI*, *MISO*) to the oscilloscope's 4 analog channels. Connect the ground potential to one of the probes' ground clip if you are using the analog channels.

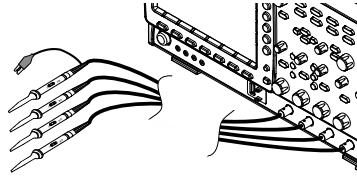
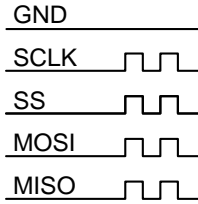

2. Press the *Bus* key.



3. Press *Bus* from the bottom menu and choose the *SPI* serial bus.



4. Press *Analog Source* to choose the sources for the SPI bus is analog.



Define Inputs

5. Press *Define Inputs* from the lower menu.

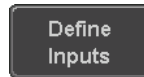

6. From the side menu choose the *SCLK*, *SS*, *MOSI* and *MISO* inputs.

SCLK	CH1~CH4
SS	CH1~CH4
MOSI	OFF, CH1~CH4 or OFF
MISO	OFF, CH1~CH4 or OFF

Configuration

The *Configure* menu sets the data line logic level, SCLK edge polarity, word size and bit order.

7. Press *Configure* from the bottom menu.

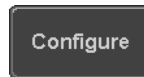

- From the side menu select SCLK edge, SS logic level, word Size and Bit order.

SCLK rising edge  , falling edge 

SS Active High, Active Low

Word Size 4 ~ 32 bits

Bit Order MS First, LS First

CAN Serial Bus Interface

The controller area network (CAN) bus is a half duplex 2 wire synchronous serial interface. The CAN bus is a multi-master communication system that relies on arbitration to solve contention issues. The MDO-2000E series supports both CAN 2.0A and 2.0B. The CAN bus uses two wires, CAN-High and CAN-Low. These wires are voltage inverted, and as such, the MDO-2000EG/2000EX only needs one wire, CAN-High or CAN-Low for decoding.

- Panel operation
- Connect the bus signal (*CAN Input*) to one of the oscilloscope's analog. Connect the ground potential to one of the probes' ground clip if you are using the analog channels.

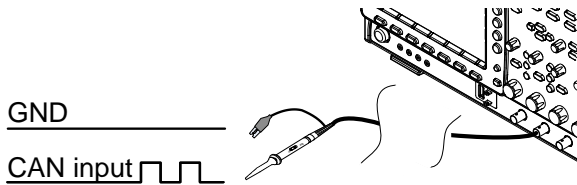

- Press the *Bus* key.



- Press *Bus* from the bottom menu and choose the *CAN* serial bus.

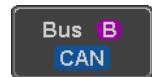

4. Press *Analog Source* to choose the source for the CAN bus is analog.



Define Inputs

5. Press *Define Inputs* from the lower menu.

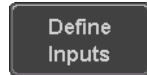

6. From the side menu choose the *CAN Input* inputs and the signal type.

CAN Input CH1~CH4

Signal CAN_H, CAN_L, Tx, Rx.
Type



Note

The *Sample Point* soft-key indicates the sampling position of each bit. This parameter is fixed.

Bit Rate

The *Bit Rate* menu sets the bit rate of the bus. The bit rate is usually tied to the bus length.

7. Press *Bit Rate* from the bottom menu and set the bit rate.

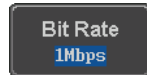

Bit Rate 10kbps, 20kbps, 50kbps, 125kbps,
250kbps, 500kbps, 800kbps, 1Mbps

LIN Serial Bus Interface

The local interconnect network (LIN) bus is a single wire interface.

- Panel operation
1. Connect the bus signal (*LIN Input*) to one of the oscilloscope's analog. Connect the ground potential to one of the probes' ground clip if you are using the analog channels.

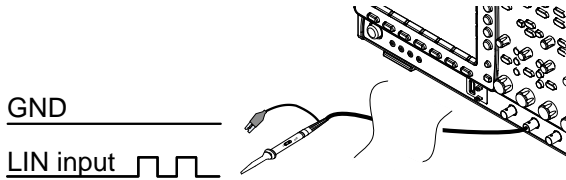

2. Press the *Bus* key.



3. Press *Bus* from the bottom menu and choose the *LIN* serial bus.



4. Press *Analog Source* to choose whether the source for the LIN bus is analog.



- Define Inputs
5. Press *Define Inputs* from the lower menu.

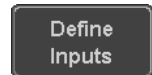

6. From the side menu choose the LIN input and the polarity of the bus.

LIN Input CH1~CH4

Polarity Normal (High = 1),
 Inverted(High = 0)



Note

The *Sample Point* soft-key indicates the sampling position of each bit. This parameter is fixed.

Configuration

The *Configure* menu sets the bit rate, the LIN standard and the parity options for the Id frame.

7. Press *Configure* from the bottom menu.

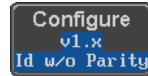

8. From the side menu select configuration items.

Bit Rate 1.2kbps, 2.4kbps, 4.8kbps,
 9.6kbps, 10.417kbps, 19.2kbps

LIN Standard V1.x, V2.x, Both

Include Parity On, Off

Bits with Id

Bus Encoding

Background

The bus that is displayed on the screen or in the event tables can be set to either hex or binary formats.

Operation

Press *Bus Display* from the Bus menu and choose either Hex or Binary from the side menu.

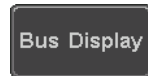

Threshold configuration

Background

The threshold levels for the Serial buses can be set to either a user-defined threshold level or to pre-set threshold.

Set the Threshold 1. Press *Threshold* from the bottom menu.



2. Press *Select* from the side menu to choose one of the lines that are configured for your type of bus.

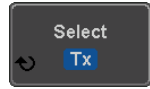

- UART Tx, Rx
- I²C SCLK, SDA
- SPI SCLK, SS, MOSI, MOSI
- CAN CAN_H, CAN_L, Tx, Rx
- LIN LIN Input

3. Press *Choose Preset* to select a pre-set logic threshold.

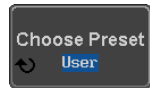

Logic Type	Threshold
TTL	1.4V
5.0V CMOS	2.5V
3.3V CMOS	1.65V
2.5V CMOS	1.25V
ECL	-1.3V
PECL	3.7V
0V	0V

4. Press *Threshold* to set a user defined threshold for the currently selected input.

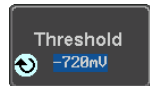

For the analog channels, the threshold level depends on the vertical scale :

Scale	Range	Scale	Range
10V/Div	±290V	50mV/Div	±5.2V

5V/Div	±270V	20mV/Div	±580mV
2V/Div	±33V	10mV/Div	±540mV
1V/Div	±29V	5mV/Div	±520mV
500mV/Div	±27V	2mV/Div	±508mV
200mV/Div	±5.8V	1mV/Div	±504mV
100mV/Div	±5.4V		

Serial Bus Event Tables

Background

The serial bus event tables list when each data event on the bus occurred. The data is displayed as either hex or binary, depending on the bus display settings.

Event tables can be saved to disk in a CSV format. The files will be named “Event_TableXXXX.CSV”, where XXXX is a number from 0000 to 9999. See page 135 for details.

Operation

1. Press *Event Table* from the bottom menu.

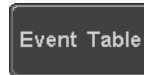

2. Press *Event Table* from the side menu to turn the event table on or off.

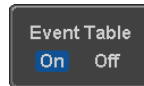

Event On, Off

Use the Variable knob to scroll through the event table.

Data Detail (I²C only)

3. To view the data at a particular address in more detail, turn *Data Detail* On. This is only available for the I²C bus.

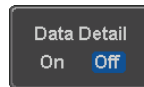

Detail On, Off

Use the Variable knob to scroll through the Data Detail event table.

- Save Event Table 4. To save the event table, press *Save Event Table*. The Event table will be saved to the current file path in a CSV format. See page 135 for details.



Use the variable knob to scroll through the event table.

Example:
UART Event table

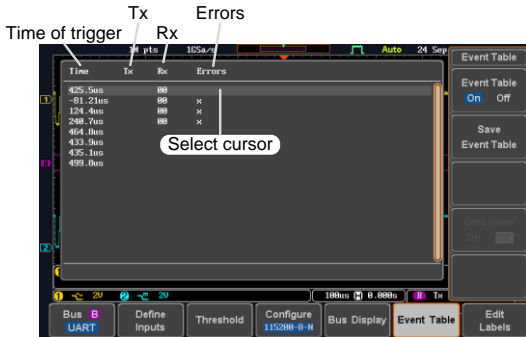

Example:
I²C Event table

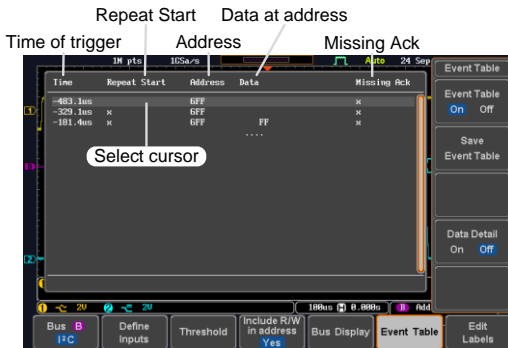

Example:
I²C Data Detail

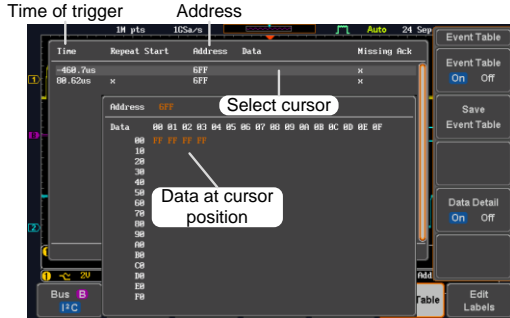

Note Data Detail is only available with the I²C bus.

Example:
SPI Event table

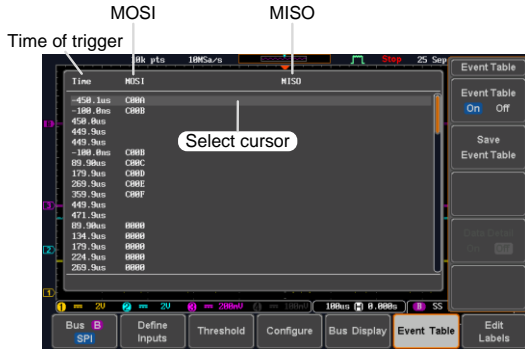

Example:
CAN Event table

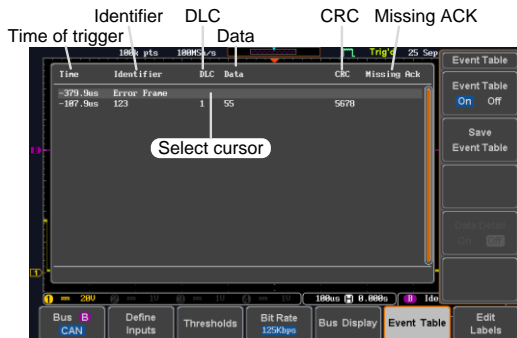

Example:
LIN Event table

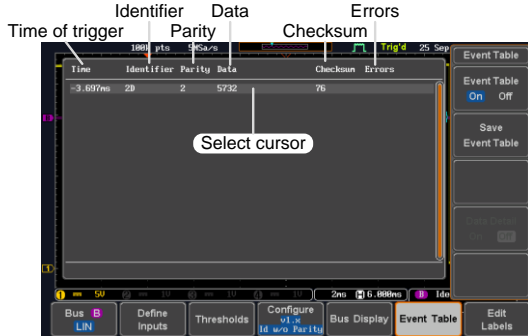

Event Tables Format

Each bus type (UART, I²C, SPI, CAN and LIN) can have an event table saved containing each bus event as a .CSV file. An event is defined as a packet/frame/word or associated set of data being successfully read according to the specific operating conditions of each bus (Start of frame, acknowledgements, checksums, etc ...). The data associated with each event and the time of each event is recorded.

File Type Each event table is saved as Event_TableXXXX.CSV into the designated file path. Each event table is numbered sequentially from 0000 to 9999. For example the first event table will be saved as Event_Table0000.CSV, the second as Event_Table0001.CSV, and so on.

Event Table Data Each event table saves a timestamp of each event relative to the trigger as well as the data in each frame/packet at the time of an event. The frame/packet data is saved in HEX format.

The table below lists in order the data saved for each event table.

UART	Time, Tx frame data, Rx frame data, Errors.
------	---

I ² C	Time, Repeat Start, Address, Data, Missing Ack.
SPI	Time, MISO frame data, MOSI frame data.
CAN	Time, Identifier, DLC, Data, CRC, Missing Ack.
LIN	Time, Identifier, Parity, Data, Checksum, Errors.

Example Below shows the data associated with an SPI event table in a spreadsheet.

Time	MOSI	MISO
-11.60us	0D87	0D87
-10.16us	06C0	06C0
-8.720us	8343	343
-7.282us	243	243
-5.840us	0C88	0C88

Adding a Label to a Bus

Background A Label can be added to the buses. This label will appear next to the bus indicator on the left hand-side of the display.

Panel Operation 1. To add a label to the bus, press *Edit Labels* from the Bus menu.



2. To choose a preset label, Press *User Preset* from the side menu and choose a label.



Labels ACK, AD0, ADDR, ANALOG, BIT, CAS, CLK, CLOCK, CLR, COUNT, DATA, DTACK, ENABLE, HALT, INT, IN, IRQ, LATCH, LOAD, NMI

Edit Label

3. Press *Edit Character* to edit the current label.



4. The Edit Label window appears.

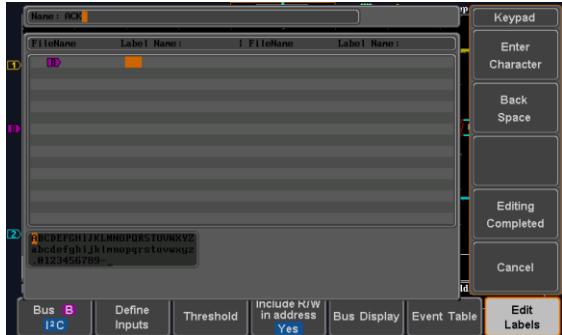

5. Use the Variable knob to highlight a character.

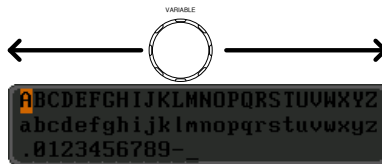

Press *Enter Character* to select a number or letter.

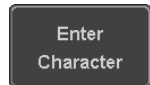

Press *Back Space* to delete a character.



Press *Editing Completed* to create the new label and return to the previous menu.

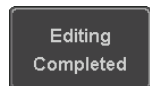

Note: this key must be pressed to save the label, even for the preset labels.

Press *Cancel* to cancel the editing and return to the Edit Label menu.

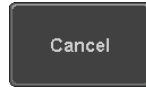

- The label will appear next to the bus indicator.

Below, the label “ACK” was created for the bus.



The bus is labeled as ACK

Remove Label

Press *Label Display* to toggle the label on or off.

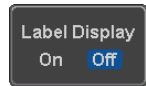

Using Cursors with the Serial Bus

Background

The cursors can be used to read bus values at any position.



Note

Ensure that one of the serial buses has been selected and is activated.

Panel Operation

- Press the *Cursor* key. Horizontal cursors appear on the display.

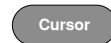

- Press the *H Cursor* soft-key and select which cursor(s) you wish to position.



Range

Description

	Left cursor (1) movable, right cursor position fixed
	Right cursor (2) movable, left cursor position fixed
	Left and right cursor (1+2) movable together

- The cursor position information appears on the top left hand side of the screen.

```

❶ -268us   Addr :0x6FF
❷ 232us   Data :0xFF
△ 500us
    
```

Example: I²C cursors.

Cursor ❶ Hor. position, Bus value(s)

Cursor ❷ Hor. position, Bus value(s)

- Use the *Variable knob* to move the movable cursor(s) left or right.

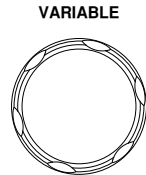

Trigger

The trigger configures the conditions for when the MDO-2000EG/2000EX captures a waveform.

Trigger Type Overview

Edge The edge trigger is the simplest trigger type. An edge trigger triggers when the signal crosses an amplitude threshold with either a positive or negative slope.

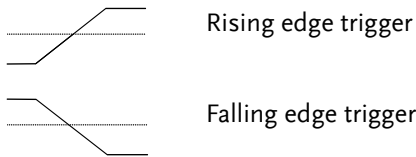

Delay The Delay trigger works in tandem with the edge trigger, by waiting for a specified time (duration) or number of events before the delay trigger starts. This method allows pinpointing a location in a long series of trigger events.

Note: when using the delay trigger, the edge trigger source can be any one of the channel inputs, the EXT* input or the AC line.

*EXT is only available on 2 channel models.

Delay trigger example (by event)

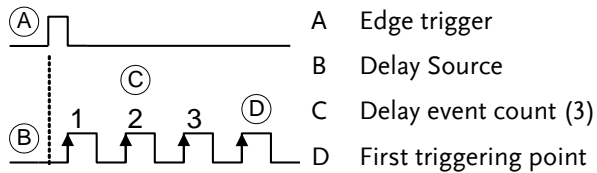

Delay trigger example (by time)

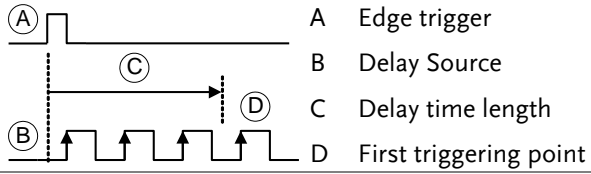

Pulse Width Triggers when the pulse width of the signal is less than, equal, not equal or greater than a specified pulse width.

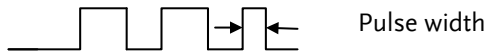

Video Extracts a sync pulse from a video format signal, and triggers on a specific line or field.

Pulse and Runt Triggers on a "runt". A runt is a pulse that passes a specified threshold but fails to pass a second threshold. Both positive and negative runts can be detected.

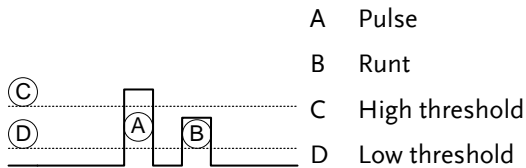

Rise and Fall (Slope) Trigger on rising and or falling edges, below or over a specified rate. The threshold can also be specified.

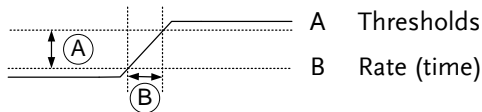

Timeout Triggers when the signal stays high, low or either for a designated amount of time. The trigger level determines when a signal is high or low.

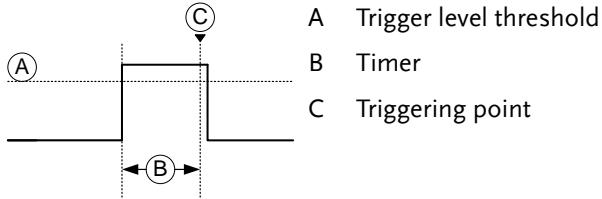

Bus Triggers on SPI, UART, I2C, CAN or LIN bus events.

Trigger: types and sources

Sources versus types	Trigger sources			
	Trigger types	Analog		
		CH1 ~ CH4	EXT*	AC Line
Edge	√	√	√	
Delay	√	√	√	
Pulse Width	√	√	√	
Video	√			
Pulse & Runt	√			
Rise & Fall (Slope)	√			
Timeout	√	√	√	
Bus	√ **			

*Only for two channels model.

**The source analog is assigned from the Bus menu.

Trigger Parameter Overview

All the following parameters are common for all the trigger types unless stated otherwise.

Trigger Source	CH1 ~ 4	Channel 1 ~ 4 input signals Except for: Logic		
	EXT *	External trigger input signal Except for: Video, Pulse Runt, Rise & Fall, Bus and Logic *Only for 2 input models.	EXT TRIG 	
	AC Line	AC mains signal Except for: Video, Pulse Runt, Rise & Fall, Bus and Logic		
	Alternate	Alternate between channel sources for the trigger source.		
	EXT Probe	For EXT trigger source only. Set the probe as either current or voltage.		
	Attenuation	For EXT trigger source only. Attenuates the EXT trigger probe by an adjustable value. Range 0.001X ~ 1000X 1-2-5 steps		
	Source Bus	UART	UART bus	
		I ² C	Inter-Integrated Circuit	
SPI		Serial Peripheral Bus		
CAN		Controller Area Network bus		
LIN		Local Interconnect Network		



Note

The Source Bus is not configurable from the Trigger menu. The field is automatically filled according to the Bus menu configuration (see page 118).

Trigger Mode	Auto (un-triggered roll)	The MDO-2000EG/2000EX generates an internal trigger if there is no trigger event, to make sure waveforms are constantly updated regardless of trigger events. Select this mode especially when viewing rolling waveforms at slower timebases.
	Normal	The MDO-2000EG/2000EX acquires a waveform only when a trigger event occurs.
	Single	When pressing the Single key, the MDO-2000EG/2000EX acquires a waveform only once when a trigger event occurs, and then stops acquiring (the oscilloscope falls into Stop mode). Press the Single key to acquire a waveform again. Please refer to Run/Stop mode for more details (page 42).

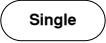









Coupling (Edge, Delay, Timeout)	DC	DC coupling.
	AC	AC coupling. Blocks DC components from the trigger circuits *.
	HF reject	High frequency filter, above 70kHz.
	LF reject	Low frequency filter, below 70kHz.
	Reject noise	DC coupling with low sensitivity to reject noise.

Slope



Trigger on a rising edge.

(Edge, Delay, Rise & Fall)		Trigger on a falling edge.	
		Either (either rising or falling edge).	
Trigger Level (Edge, Delay)	Level	Adjusts the trigger level manually using the Trigger LEVEL knob.	
	Set to TTL 1.4V	Sets the trigger level to 1.4V, suitable for triggering on TTL signals.	
	Set to ECL - 1.3V	Sets the trigger to -1.3V. This is suitable for ECL circuits.	
	Set to 50%	Sets the trigger level to 50% of the waveform amplitude.	
Holdoff	Holdoff	Sets the holdoff time.	
	Set to Minimum	Set the holdoff time to the minimum.	
Delay (Delay)	Time	Sets the delay time (4ns ~ 10s) between the trigger event and the real trigger timing.	
	Event	Sets the number of events (1 ~ 65535) passed after the trigger event, until the real trigger timing.	
	Set to Minimum	Sets the source trigger to the minimum time.	
When (Pulse Width)	Sets the pulse width (4ns ~ 10s) and the triggering condition.		
	>	Longer than	=
<	Shorter than	≠	Not equal to

Threshold (Pulse Width)	Sets the amplitude threshold level for the pulse widths.	
	Threshold	-XXV ~ +XXV, user-set level
	Set to TTL	1.4V
	Set to ECL	-1.3V
	Set to 50%	Sets the threshold to 50%
Standard (Video)	NTSC	National Television System Committee
	PAL	Phase Alternate by Line
	SECAM	SEquential Couleour A Memoire
Polarity (Pulse Width, Video)		Positive polarity (triggered on the high to low transition)
		Negative polarity (triggered on the low to high transition)
Polarity (Pulse Runt)		Positive polarity (positive runt)
		Negative polarity (negative runt)
		Either (either negative or positive runt)
Trigger On (Video)	Selects the trigger point in the video signal.	
	Odd Field	NTSC: 1 ~ 263 PAL/SECAM: 1 ~ 313 EDTV: 1~525(480P), 1~625(576P) HDTV: 1~750(720P), 1~563(1080i), 1~1125(1080P)
	Even Field	NTSC: 1 ~ 262, PAL/SECAM: 1 ~ 312 HDTV: 1~562(1080i)
	All Fields	Triggers on all fields.
	All Lines	Triggers on all lines.

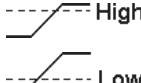
Threshold (Pulse Runt)		Sets the upper threshold limit. Sets the lower threshold limit.
Threshold (Rise & Fall)		Sets the High threshold. Sets the Low threshold.
Trigger When (Timeout)	<p>Stays High</p> <p>Stays Low</p> <p>Either</p>	Triggers when the input signal stays high for a designated amount of time. Triggers when the input signal stays low for a designated amount of time. Triggers when the input signal stays high or low for a designated amount of time.
Timer (Timeout)	4nS~10.0S	Sets the amount of time that a signal must stay high or low for the timeout trigger.

Setup Holdoff Level

Background

The holdoff function defines the waiting period before the MDO-2000EG/2000EX starts triggering again after a trigger point. The holdoff function ensures a stable display if there are a number of points in a periodic waveform that can be triggered. Holdoff applies to all the triggering types except the trigger by bus.

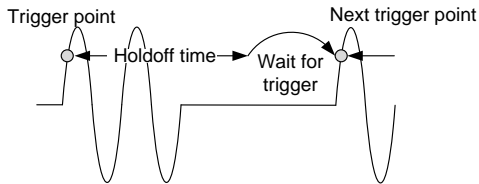

Panel Operation 1. Press the trigger *Menu* key.



2. To set the Holdoff time, press the *Holdoff* (or *Mode/Holdoff*) menu button on the bottom bezel.



3. Use the side menu to set the Holdoff time.

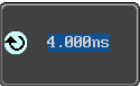

Range 4ns~10s

Pressing *Set to Minimum* sets the Holdoff time to the minimum, 4ns.





Note





Note: The holdoff function is automatically disabled when the waveform update mode is in roll mode (page 104).

Setup Trigger Mode

Background The trigger mode can be set to Normal or Auto (untriggered roll). The triggering mode applies to all the trigger types.

- Panel Operation**
1. Press the Trigger menu key. 
 2. Press *Mode* from the bottom menu to change the triggering mode. 
 3. Use the side panel to select *Auto* or *Normal* triggering modes.
Range Auto, Normal

Using the Edge Trigger

- Panel Operation**
1. Press the trigger *Menu* key. 
 2. Press *Type* from the lower bezel menu. 
 3. Select *Edge* from the side menu. The edge trigger indicator appears at the bottom of the display. 

From left: trigger source, slope, trigger level, coupling
 4. Press *Source* to change the trigger source. 

5. Use the side menu to select the trigger source type.

Range Channel 1 ~ 4 (Alternate On/Off),
EXT (Ext Probe: Volt/Current,
Attenuation: 1mX~1kX, CH2
models only), AC Line.

6. Press *Coupling* from the bottom bezel menu to select the trigger coupling or frequency filter settings.



Choose the coupling from the side menu.

Range DC, AC, HF Reject, LF Reject

7. Toggle *Noise Rejection* On or Off from the side menu.

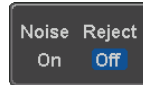

Range On, Off

8. From the bottom menu press *Slope* to toggle the slope type.



Range Rising edge, falling edge, either

9. To set the external trigger level, select *Level* from the bottom bezel menu (Not applicable for AC line source).

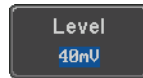

10. Set the external trigger level using the side menu.

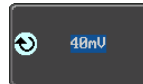

Analog channel 00.0V~ 5 screen divisions
Range Set to TTL 1.4V
Set to ECL -1.3V
Set to 50%

Using Advanced Delay Trigger

Panel Operation 1. Set the edge trigger source. This will set the initializing trigger for the delay source. Page 149

2. Press the trigger *Menu* key.



3. Press *Type* from the lower bezel menu.



4. Select *Delay* from the side menu. The delay trigger indicator appears at the bottom of the display.

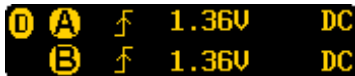

From left: Delay trigger indicator (D), edge trigger (A), edge slope, edge level, edge coupling, delay trigger (B), delay slope, delay trigger level, delay coupling.

5. To set the delay source, press *Source* and select a source from the side menu.



Source CH1 ~ CH4, AC Line, EXT*
*2 channel models only.

6. Press *Coupling* from the bottom bezel menu to select the trigger coupling or frequency filter settings.

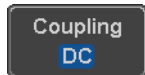

Choose the coupling from the side menu.

Range DC, AC, HF Reject, LF Reject

7. To set the delay press *Delay* from the bottom bezel. 

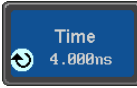
8. To Delay by Time (Duration), press *Time* from the side menu and set the delay time. 

Range 4ns ~ 10s (by time)
Set to minimum

9. To Delay by Event, press *Event* from the side menu and set the number of events. 

Range 1 ~ 65535 events
Set to Minimum

Using Pulse Width Trigger

- Panel Operation
1. Press the trigger *Menu* key. 

 2. Press the *Type* key from the lower bezel menu. 

 3. Select *Pulse Width* from the side menu. The pulse width trigger indicator appears at the bottom of the display. 



From left: source, polarity, when, coupling

 4. Press *Source* from the lower bezel. 

- Use the side menu to select the pulse width trigger source.

Range Channel 1 ~ 4 (Alternate On/Off),
EXT (Ext Probe: Volt/Current,
Attenuation: 1mX~1kX, CH2
models only), AC Line.

- Press *Polarity* to toggle the polarity type.



Range Positive (high to low transition)
Negative (low to high transition)

- Press *When* from the lower bezel.

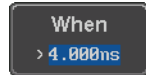

Then use the side menu to select the pulse width condition and width.

Condition > , < , = , ≠

Width 4ns ~ 10s

- Press *Threshold* from the lower bezel to edit the pulse width threshold.

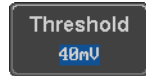



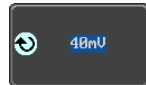

- Set the threshold level using the side menu.



Analog channel 00.0V~ 5 screen divisions
Range Set to TTL 1.4V
Set to ECL -1.3V
Set to 50%

Using Video Trigger

- Panel Operation
- Press the trigger *Menu* key. 
 - Press the *Type* key from the lower bezel menu. 
 - Select *Video* from the side menu. The video trigger indicator appears at the bottom of the display. 

 **NTSC Odd 1 DC**

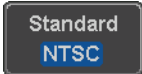
From left: source, video standard, field, line, coupling
 - Press *Source* from the lower bezel. 
 - Use the side menu to select the video trigger source.
Range Channel 1 ~ 4
 - Press *Standard* on the bottom bezel. 

Use the side menu to select the video standard.
Range NTSC, PAL, SECAM, EDTV(480P, 576P), HDTV(720P, 1080i, 1080P)

7. Press *Trigger On* to edit the video field and line.



Use the side menu to select the field and line.

Odd Field NTSC: 1 ~ 263
 PAL/SECAM: 1 ~ 313
 EDTV: 1~525(480P), 1~625(576P)
 HDTV: 1~750(720P), 1~562(1080i),
 1~1125(1080P)

Even Field NTSC: 1 ~ 262
 PAL/SECAM: 1 ~ 312
 HDTV: 1~563(1080i)

All Fields Triggers on all fields.

All Lines Triggers on all lines.

8. Press *Polarity* to toggle the polarity type.



Range positive, negative

Pulse Runt trigger

- Panel Operation 1. Press the trigger *Menu* key.



2. Press the *Type* key from the lower bezel menu.



3. Select *Others* → *Pulse Runt* from the side menu. The Pulse and Runt indicator appears at the bottom of the display.

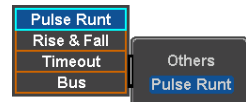

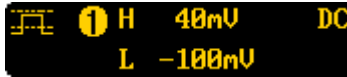

From left: polarity, source, high/low threshold, threshold level, coupling

4. Press *Source* from the lower menu.



Use the side menu to select a source.

Range Channel 1 ~ 4(Alternate On/Off)

5. Press *Polarity* to toggle the polarity.



Range Rising edge, falling edge, either.

6. Press *When* from the lower menu.

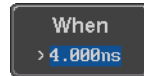

Then use the side menu to select the condition and width.

Condition >, <, =, ≠

Width 4ns ~ 10s

7. Press *Threshold* from the lower bezel to edit the threshold for the upper and lower threshold.



8. Use the side menu to set the upper threshold.



Range -XXV~XXV

9. Use the side menu to set the lower threshold.



Range -XXV~XXV

Using Rise and Fall Trigger

Panel Operation 1. Press the trigger *Menu* key.



2. Press the *Type* key from the lower bezel menu.



3. Select *Others* → *Rise and Fall* from the side menu. The Rise and Fall indicator appears at the bottom of the display.

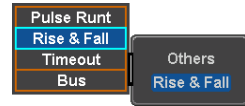

From left: slope, source, high/low threshold, threshold level, coupling

4. Press *Source* from the lower menu.



Use the side menu to select a source.

Range Channel 1 ~ 4(Alternate On/Off)

5. Press *Slope* from the bottom menu to toggle the slope.



Range Rising edge, falling edge, either

6. Press *When* from the lower menu.

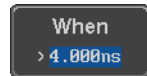

Then use the side menu to select the logic conditions and true or false status.

Condition > , < , = , ≠

Width 4ns ~ 10s

- Press *Threshold* from the lower bezel to edit the High and Low threshold.



Range High: -XXV~XXV
Low: -XXV~XXV

Using the Timeout Trigger

- Panel Operation 1. Press the trigger *Menu* key.



- Press the *Type* key from the lower bezel menu.



- Select *Others* → *Timeout* from the side menu. The Timeout indicator appears at the bottom of the display.

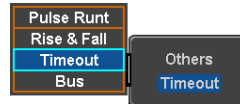

Timeout 1.40V DC

From left: Source, Trigger type, threshold level, coupling

- Press *Source* from the lower menu.



Use the side menu to select a source.

Range Channel 1 ~ 4 (Alternate On/Off),
EXT (Ext Probe: Volt/Current,
Attenuation: 1mX~1kX, CH2
models only), AC Line.

5. Press *Coupling* from the bottom bezel menu to select the trigger coupling or frequency filter settings.



Choose the coupling from the side menu.

Range DC, AC, HF Reject, LF Reject

6. Toggle *Noise Rejection* On or Off from the Coupling side menu.

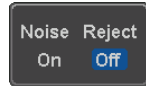

Range On, Off

7. Press *Trigger When* from the lower menu.



Then use the side menu to select trigger conditions.

Condition Stays High, Stays Low, Either

8. Press *Level* from the lower bezel to set the trigger level.

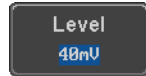

9. Set the level using the side menu.

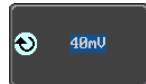

Analog channel 00.0V~ 5 screen divisions
 Range Set to TTL 1.4V
 Set to ECL -1.3V
 Set to 50%

10. Press *Timer* from the lower bezel to set the timer time.

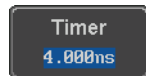

Range 4ns~10.0S

Using the Bus Trigger

The Bus trigger is used to trigger the oscilloscope on UART, I2C, SPI, CAN or LIN serial bus signals or on bus data.

UART BUS Trigger Settings

The UART bus trigger conditions can be set at any time after the bus settings have been set to *UART*.

Panel Operation 1. Set the Bus to UART in the bus menu. Page 122

2. Press the *Trigger Menu* key.



3. Press *Type* from the bottom menu.



4. Press *Others* from the side menu and select *Bus*.

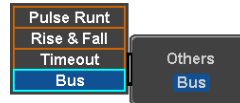

The Trigger on settings will be reflected on the Trigger Configuration icon.

B Tx Data

From left: Bus trigger, Trigger source

5. Press *Trigger On* and select the triggering condition for the UART bus.



Trigger On Tx Start Bit, Rx Start Bit, Tx End of Packet, Rx End of Packet, Tx Data, Rx Data, Tx Parity Error, Rx Parity Error

Trigger On – Tx Data, Rx Data If Tx Data or Rx Data was configured for the Trigger On setting, then the number of bytes and data can also be configured.

6. Press *Data* from the bottom menu.

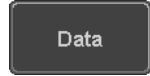

7. Press *Number of Bytes* from the side menu and choose the number of bytes for the data.

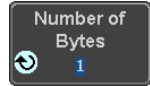

UART 1~10 Bytes

8. Press *Data* from the side menu to edit the triggering data.

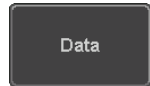

To edit the data, use the *Variable* knob to highlight a binary or hex digit and press *Select*. Use the *Variable* knob to choose a value for the digit and press *Select* to confirm.

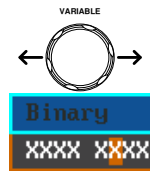

- Binary 0,1,X (don't care)
- Hex 0~F, X (don't care)
- ASCII ASCII characters for the equivalent Hex characters 00 to FF

I²C Bus Trigger Settings

The I²C bus trigger conditions can be set at any time after the bus settings has been set to I²C.

Panel Operation 1. Set the Bus to I²C in the bus menu. Page 124

2. Press the *Trigger Menu* key.



3. Press *Type* from the bottom menu.



4. Press *Others* from the side menu and select *Bus*.

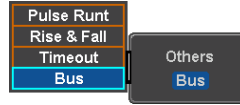

The Trigger on settings will be reflected on the Trigger Configuration icon.



From left: Bus trigger, Trigger source

5. Press *Trigger On* and select the triggering condition for the selected bus.



Trigger On Start, Repeat Start, Stop, Missing Ack, Address, Data, Address/Data

Trigger On – Data

If Data or Address/Data was configured for the Trigger On setting, then the number of bytes, data and addressing mode (I²C) can be configured.

6. Press *Data* from the bottom menu.



7. Press *Number of Bytes* from the side menu and choose the number of bytes for the data.

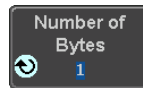

I²C 1~5 Bytes

8. Press *Addressing Mode* to toggle between 7 and 10 bit addressing modes.



9. Press *Data* from the side menu to edit the triggering data.

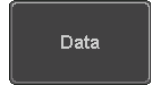

To edit the data, use the *Variable* knob to highlight a binary or hex digit and press *Select*. Use the *Variable* knob to choose a value for the digit and press *Select* to confirm.

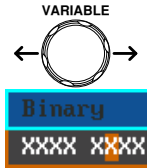

Binary 0,1,X (don't care)

Hex 0~F, X (don't care)

Trigger On -
Address

If Address or Address/Data was configured for the Trigger On setting, then the triggering address must be configured.

10. Press *Address* on the bottom menu.

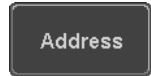

11. Press *Addressing Mode* to toggle between 7 and 10 bit addressing modes.



12. To choose a preset address as the default address, press *Choose Preset* and select a preset address.

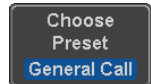

Address	Description
0000 000 0	General Call
0000 000 1	START Byte
0000 1XX X	Hs-mode
1010 XXX X	EEPROM
0000 001 X	CBUS

Press *Apply Preset* to set the default address to the preset.

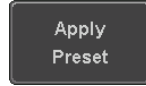

Note

- Presets are not available for *Trigger On Address/Data*.

13. Press *Address* from the side menu to manually edit the triggering address.

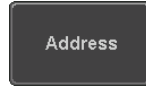

To edit the address, use the *Variable* knob to highlight a binary or hex digit and press *Select*. Use the *Variable* knob to choose a value for the digit and press *Select* to confirm.

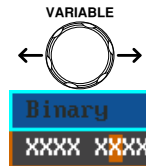

Binary 0,1, X (don't care)

Hex 0~F, X (don't care)

Direction

14. Press *Direction* on the bottom menu and choose the direction from the side menu.

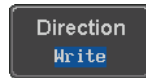

Direction Write, Read, Read or Write

SPI Bus Trigger Settings

The SPI bus trigger conditions can be set at any time after the bus setting has been set to SPI.

Panel Operation

1. Set the Bus to SPI in the bus menu. Page 125

2. Press the *Trigger Menu* key.



3. Press *Type* from the bottom menu.



4. Press *Others* from the side menu and select *Bus*.

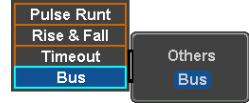

The Trigger on settings will be reflected on the Trigger Configuration icon.



From left: Bus trigger, Trigger source

5. Press *Trigger On* and select the triggering condition for the SPI bus.

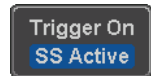

SPI SS Active, MOSI, MISO,
MOSI&MISO

Trigger On – Data

If MOSI, MISO or MISO/MOSI was configured for the Trigger On setting, then the number of words and the data can be configured.

6. Press *Data* from the bottom menu.

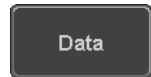

7. Press *Number of Words* from the side menu and choose the number of words for the data.

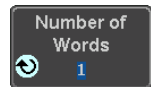

SPI 1~32 Words

- Press *MOSI* or *MISO* from the side menu to edit the triggering data.

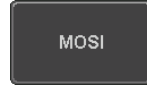

To edit the data, use the *Variable* knob to highlight a binary or hex digit and press *Select*. Use the *Variable* knob to choose a value for the digit and press *Select* to confirm.

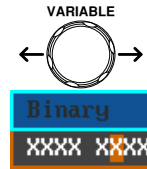

Binary 0,1,X (don't care)

Hex 0~F, X (don't care)

CAN Bus Trigger

The CAN bus trigger conditions can be set at any time after the bus setting has been set to CAN.

- Set the Bus to CAN in the bus menu.

Page 127

- Press the *Trigger Menu* key.



- Press *Type* from the bottom menu.



- Select *Others* → *Bus* from the side menu. The Bus indicator appears at the bottom of the display.

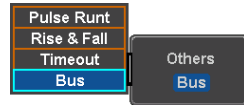

The Trigger on settings will be reflected on the Trigger Configuration icon.



From left: Bus trigger, Trigger source

5. Press *Trigger On* and select the triggering condition for the selected bus.



Trigger On Start of Frame, Type of Frame, Identifier, Data, Id & Data, End of Frame, Missing Ack, Bit Stuffing Err

Trigger On –Type of Frame

6. If *Type of Frame* was configured for the Trigger On setting, then the type of frame can be configured from the side menu.

Type Data Frame, Remote Frame, Error Frame, Overload Frame

Trigger On – Identifier

7. If *Identifier/Id & Data* was configured for the Trigger On setting, select the format from the side menu.

Format Standard, Extended

8. Press *Identifier* from the side menu to set the identifier data.

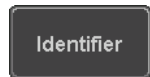

To edit the identifier, use the *Variable* knob to highlight a binary or hex digit and press *Select*. Use the *Variable* knob to choose a value for the digit and press *Select* to confirm.

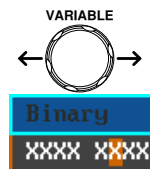

Binary 0,1,X (don't care)

Hex 0~F, X (don't care)

9. Press *Direction* on the bottom menu and select the CAN Direction from the side menu.

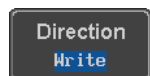

CAN Direction Write, Read, Read or Write

Trigger On - Data

If *Data/Id and Data* was configured for the Trigger On setting, then the triggering data must be configured.

10. Press *Data* on the bottom menu.

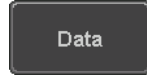

11. Press *Number of Bytes* from the side menu and choose the number of bytes for the data.

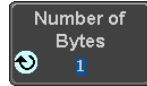

Bytes 1~8 Bytes

12. Press *Data* from the side menu to edit the triggering data.

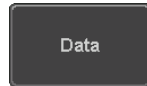

To edit the data, use the *Variable* knob to highlight a binary or hex digit and press *Select*. Use the *Variable* knob to choose a value for the digit and press *Select* to confirm.

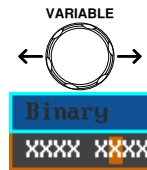

Binary 0,1,X (don't care)

Hex 0~F, X (don't care)

13. Press *Trigger When* from the side menu to choose the triggering condition for the data.

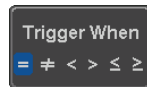

When =, ≠, <, >, ≤, ≥

14. The oscilloscope will now trigger when the specified bus data matches the *Trigger When* conditions.

LIN Bus Trigger

The LIN bus trigger conditions can be set at any time after the bus setting has been set to LIN.

Panel Operation 1. Set the Bus to LIN in the bus menu. Page 129

2. Press the *Trigger Menu* key.



3. Press *Type* from the bottom menu.



4. Select *Others* → *Bus* from the side menu. The Bus indicator appears at the bottom of the display.

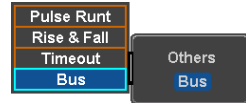

From left: Bus trigger, Trigger source

5. Press *Trigger On* and select the triggering condition for the selected bus.



Trigger On Sync, Identifier, Data, Id and Data, Wakeup Frame, Sleep Frame, Error.

Trigger On – Identifier

6. If *Identifier* or *Id & Data* was configured for the Trigger On setting, press *Identifier* from the bottom menu.

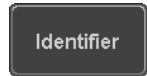

7. Press *Identifier* from the side menu to set the identifier data.

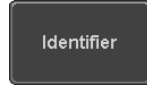

To edit the identifier, use the *Variable* knob to highlight a binary or hex digit and press *Select*. Use the *Variable* knob to choose a value for the digit and press *Select* to confirm.

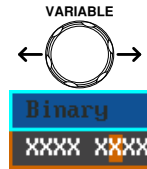

Binary 0,1,X (don't care)

Hex 0~F, X (don't care)

Trigger On - Data

If *Data/Id and Data* was configured for the Trigger On setting, then the triggering data must be configured.

8. Press *Data* on the bottom menu.

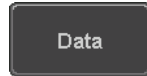

9. Press *Number of Bytes* from the side menu and choose the number of bytes for the data.

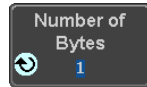

Bytes 1~8 Bytes

10. Press *Data* from the side menu to edit the triggering data.

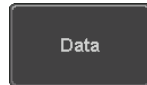

To edit the data, use the *Variable* knob to highlight a binary or hex digit and press *Select*. Use the *Variable* knob to choose a value for the digit and press *Select* to confirm.

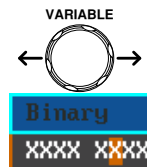

Binary 0,1,X (don't care)

Hex 0~F, X (don't care)

11. Press *Trigger When* from the side menu to choose the triggering condition for the data.

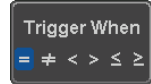

When =, ≠, <, >, ≤, ≥

12. The oscilloscope will now trigger when the specified bus data matches the *Trigger When* conditions.

Search

The search feature can be used to search for events on the analog channels. The events that can be searched for are similar to the events that are used for the trigger system. The only difference is that the search feature uses the measurement threshold levels rather than the trigger level to determine events.

Configuring Search Events



Background Similar to configuring the trigger system, the Search events must first be configured before they can be found.

Luckily the trigger system configuration settings can also be used for the search events. The types of searches are listed below. Please note that a full description of the events can be found in the Trigger section on page 140.

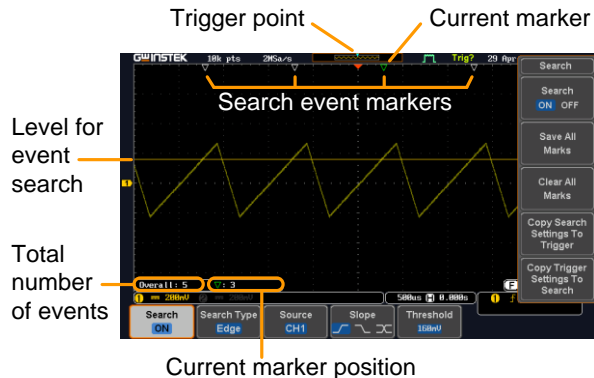
Display



Search Event Types Edge, Pulse Width, Runt, Rise and Fall Time, FFT Peak*, Logic and Bus
 *The FFT Peak search event doesn't have a trigger equivalent.

- Panel Operation
1. Press the *Search* menu key. 
 2. Press *Search* from the bottom menu and turn the Search function on. 
 3. Press *Search Type* from the bottom menu and select the type of search. The search events are configured in the same fashion as the trigger events. 

Please see the trigger configuration settings for details:

Event	Edge, Pulse Width, Runt, Rise/Fall
Types:	Time, FFT Peak*, Bus
	*No trigger equivalent.
 4. Select the source from which to search events. Press *Source* from the bottom menu, and select the source. 

Sources: CH1 ~ CH4, Math
 5. To set the threshold levels for the search events (instead of the trigger level that is used for trigger events), use the threshold soft-key from the bottom menu. 



Note

The search function can support up to 10,000 events, however only 1,000 events can be displayed on screen at once.

Copying Search Event To/From Trigger Events

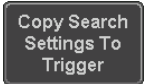
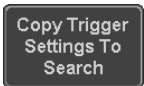
Background	As the trigger system and search feature have similar settings, their settings can be used interchangeably by using the Copy functions.	
Interchangeable Settings	Edge, Pulse Width, Pulse Runt, Rise and Fall Times and Bus (FFT Peak has no trigger equivalent)	
Panel Operation	<ol style="list-style-type: none"> 1. Press <i>Search</i> from the lower bezel menu. 	
	<ol style="list-style-type: none"> 2. To copy the settings of the selected search type to the trigger settings, select <i>Copy Search Settings to Trigger</i>. 	
	<ol style="list-style-type: none"> 3. To copy over the current trigger settings to the search settings, press <i>Copy Trigger Settings To Search</i>. 	



Note

If the settings cannot be copied or if there are no trigger settings configured (so that you cannot copy from the trigger settings), then those particular options will not be available.

Search Event Navigation

Background	When using the search feature, each event can be searched according to the event settings.	
Operation	<ol style="list-style-type: none"> 1. Turn Search on and set the appropriate search type. 	Page 172

2. Search events are marked by hollow white triangles at the top of the graticule.
3. Use the search arrow keys to move between each search event.

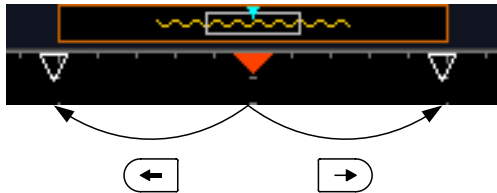

Search events can be navigated in both stop and run mode.



When using the arrow keys to navigate to each event, the “current event” will always be centered on the display.

Save Search Marks

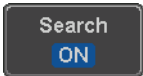
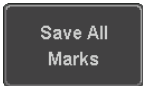
Background The search events can be saved to the graticule display, allowing you to superimpose new search events. Search events are saved over the entire record length, with a maximum of 1000 marks.

- | | |
|-------------------|---|
| Save Marks | <ol style="list-style-type: none"> 1. Press <i>Search</i> from the lower bezel menu.  2. Press the <i>Save All Marks</i> soft-key.  3. The search event markers will become solid white triangles to indicate that they have been saved.  |
|-------------------|---|

Clear All Marks

To clear all the saved marks, press
Clear All Marks from the side
menu.

 A dark grey rectangular button with rounded corners, containing the text "Clear All Marks" in white.

Note



Each time the Save All Marks function is used, the previously saved marks will also be retained, unless cleared.

Setting/Clearing Single Search Events

Background

In addition to searching for search events based on Search Type settings, custom search marks can be created with the Set/Clear key.

Set Search Event

1. Navigate to a point of interest using  POSITION  the horizontal position knob or some other method.



 A small rectangular button with rounded corners, containing the text "PUSH TO ZERO" in black.

2. Press the *Set/Clear* key.

 A small oval-shaped button with rounded corners, containing the text "Set/Clear" in black.

3. A marker will be saved at the center of the display.

- This marker can be navigated to/from in the same way that a normally saved search marker can.

Clear Search Event

To clear a set search event, use the search arrows to navigate to the event of interest and press the Set/Clear key.

 A small oval-shaped button with rounded corners, containing the text "Set/Clear" in black.

The marker will be deleted from the display.

FFT Peak

Background The FFT Peak search type can be used to mark all FFT peaks that are above a certain threshold.

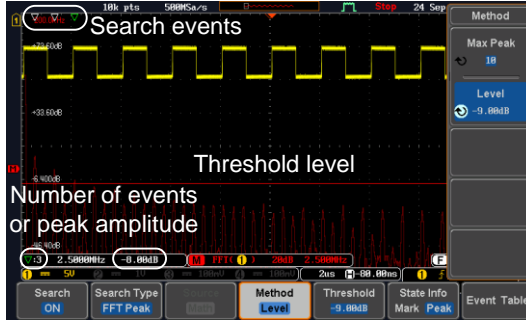

Note

The search function can support up to 10,000 events, however only 1,000 events can be displayed on screen at once.

Panel Operation 1. Turn the FFT math function on. Page 69

2. Press the *Search* menu key.



3. Press *Search* from the bottom menu and turn the Search function on.



4. Press *Search Type* from the bottom menu and select *FFT Peak* from the side menu.



5. Note that the Math source is automatically selected.

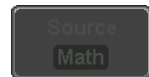

6. Next, select the event search method by pressing *Method* from the bottom menu.



Select *Max Peak* to search by a selected number of "max" peaks.



Select *Level* to set the threshold level for the search events. Any peaks above the threshold level will be seen as a search event.

The threshold level will be mirrored in the Threshold key.



Max Peak 1 ~ 10

Level -100db ~ 100dB

View Number of Peak Events

To view the number of peak events, set *State Info* to Mark. The number of search events will be shown at the bottom of the screen.



View Amplitude of Peak Search Event

To view the position and amplitude of a selected event, set *State Info* to Peak. This information will be shown at the bottom of the display.



Peak Event Table The Event Table function tabulates the amplitude and frequency of each peak event in real time. The event table can also be saved to a USB disk drive. File names are saved as a PeakEventTbXXXX.csv, where XXXX is a number starting from 0001 and is incremented each time the event table is saved.

7. Press *Event Table* from the bottom menu and turn the Event Table function on.



The event table will appear on the screen.

No.	Frequency	Value
1	1.0000Hz	-30.4dB
2	2.0000Hz	-31.2dB
3	3.0000Hz	-32.8dB
4	4.0000Hz	-35.2dB
5	5.0000Hz	-39.4dB
6	6.0000Hz	-44.8dB
7	7.0000Hz	-54.4dB
8	9.0000Hz	-52.8dB
9	10.0000Hz	-51.2dB
10	11.0000Hz	-52.8dB
11	12.0000Hz	-58.4dB
12	497.0000Hz	-58.4dB
13	498.0000Hz	-56.0dB
14	499.0000Hz	-54.4dB

Amplitude

Peak frequency

Peak number

- Save Event Table**
8. To save the event table, insert a USB memory drive into the front panel USB-A port.

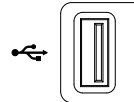

9. Press *Save Event Table*. The event table will be saved as PeakEventTbXXXX.csv.

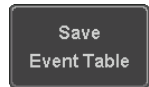

Event Table CSV Format The format for the CSV file is the same as the event table displayed on the MDO-2000EG/2000EX screen; No., Frequency, and Value.

For example:

No.	Frequency	Value
1	1.0000MHz	-29.6dB
2	2.0000MHz	-30.4dB
3	3.0000MHz	-32.0dB

Center Peak Results on Screen To shift the peak events to the center of the screen, press *Selected Peak To Center* from the event table side menu.

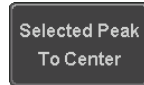

System Settings and Miscellaneous Settings

This section describes how to set the interface, language, time/ date, probe compensation signal, erase the internal memory and access useful QR codes.

Select Menu Language

Description The MDO-2000EG/2000EX has a number of different languages to choose from.

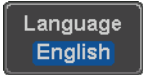
- Panel Operation**
1. Press the *Utility* key. 
 2. Press *Language* on the lower menu. 
 3. Select the language* from the side menu.
*Language selection may differ based on region, and as such are not listed here.

View System Information

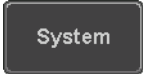
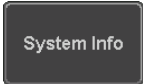
- Panel Operation**
1. Press the *Utility* key. 
 2. Press *System* from the lower menu. 
 3. Press *System Info* from the side menu. A display panel will appear showing:
 - Manufacturer name
 - Model name
 - Serial number
 - Firmware version
 - Manufacturer URL

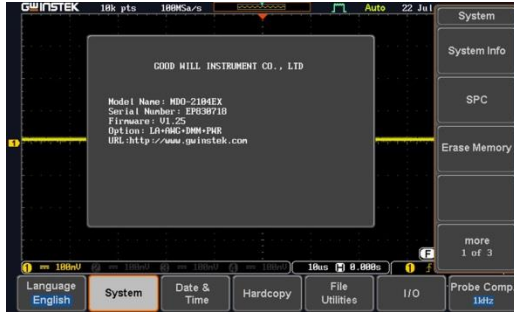

Erase Memory

Background The Erase Memory function will erase all internal waveforms, setup files and labels from internal memory.

Erased Items Waveform 1~20, Setting memory 1~20, Reference 1~4, Labels

Panel Operation 1. Press the *Utility* key.



2. Press *System* from the lower menu.

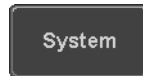

3. Press *Erase Memory* from the side menu.

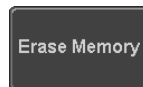

A message will prompt you to press Erase Memory again to confirm the process. Pressing any other key will cancel erasing the memory.

4. Press *Erase Memory* again.

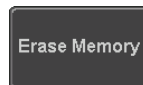

Set Date and Time

Panel Operation/
Parameter

1. Press the *Utility* key.



2. Press *Date & Time* on the lower menu.



3. Set the *Year, Month, Day, Hour* and *Minute* from the side menu.

Year 2000 ~ 2037

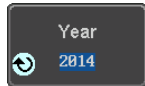

Month 1 ~ 12

Day 1 ~ 31

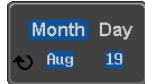

Hour 1~23

Minute 0~59



4. Press *Save Now* from the side menu to save the date and time.

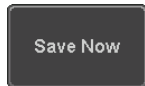

5. Make sure the date/time setting is correctly reflected at the top of the display.



Probe Compensation Frequency

Background The probe compensation output can be set from 1kHz (default) to 200kHz, in steps of 1kHz.

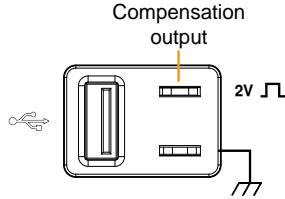

**Panel Operation/
Parameter**

1. Press the *Utility* key.



2. Press *Probe Comp.* on the lower menu.

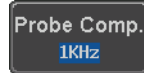

3. Press *Frequency* and change the frequency of the probe compensation signal.

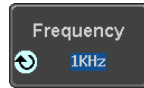

Default Frequency

4. Press *Default* to set the frequency of the probe compensation signal to 1kHz default.



QR Code Reader Function

Background The QR Code reader function displays a number of preset QR codes that link to useful websites.

QR Code Items

- GW Instek website
- GW Instek contact window (marketing department)

Panel Operation/

1. Press the *Utility* key.



Parameter

2. Press *System* from the lower menu.

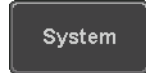

3. Press *More 1 of 3*, *More 2 of 3* from the side menu.



4. Press *QR Code* from the side menu. There will be two pages of QR codes to choose from.

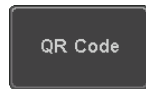

Press *Page 1* or *Page 2* to navigate to each page.

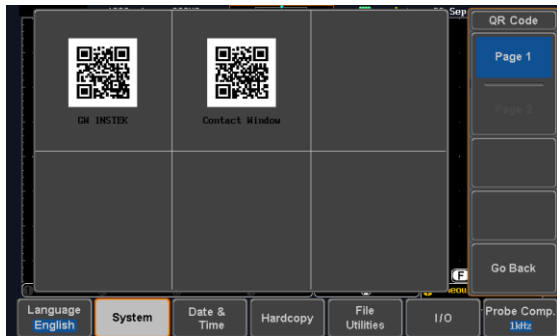

5. Use a QR code reader app on your smart phone or tablet to read one of the QR codes.

ARBITRARY WAVE GENERATOR

Arbitrary Wave Generator Operation	187
Overview	187
Rear Panel.....	187
AWG Display Overview.....	188
Generator Connection	188
Output Setup	189
Select the Active Channel.....	189
Turn the Output On for the Selected Channel	190
Setting the Load Impedance	190
Setting the Phase	190
GEN1 and GEN2 Setup	191
Selecting a Waveform.....	191
Waveform Settings.....	192
AM Modulation.....	195
FM Modulation	197
FSK Modulation.....	199
Sweep	201
Manage Arbitrary Waveforms.....	203
Create New ARB Waveform	203
Edit an Existing ARB Waveform.....	205
Load ARB Waveform	212
Save ARB Waveform	214
Coupling and tracking waveforms settings.....	216

Arbitrary Wave Generator Operation

Overview

Background	The AWG is a full-function dual channel arbitrary waveform generator.
Waveforms	Arbitrary, Sine, Square, Pulse, Ramp, DC, Noise, Sinc, Gaussian, Lorentz, Exp. Rise, Exp. Fall, Haversine, Cardiac
Functions	AM, FM, FSK, Sweep

Rear Panel

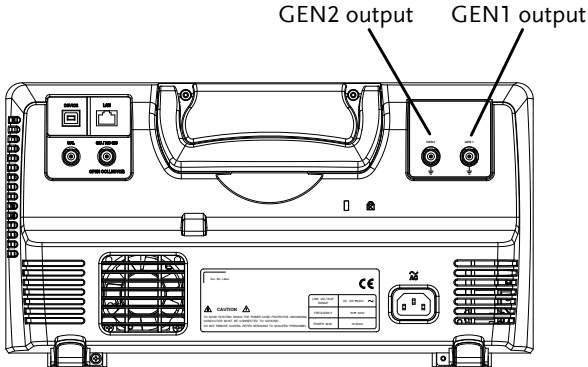

GEN1 and GEN2 Output

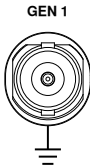

Outputs for the Generator 1 or Generator 2 signals.

AWG Display Overview

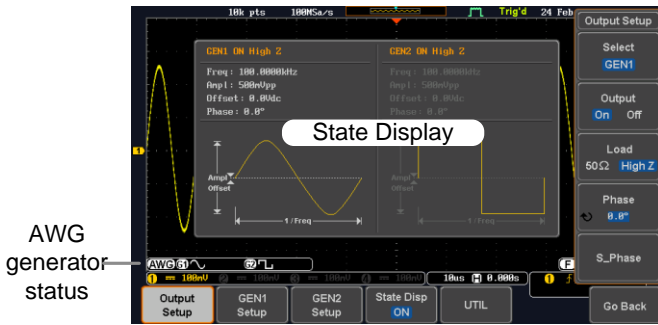

State Display The state display is used to visually show the major channel settings when you are in the AWG menu.

AWG Generator Status Indicators The AWG channel status indicators show the active channels, output waveforms and function.

AWG AWG status indicator

G1 Channel status indicator (G1, G2)

Waveform icon Waveform indicator of the indicated channel (Sine, arbitrary, pulse etc...).

+AM Function indicator for the indicated channel (AM, FM, FSK, SWP).

Generator Connection

Background This section will explain how to connect a DUT to the channel outputs.

- Connection
1. Connect the BNC output (GEN1 or GEN2) to the DUT using the GTL-101 BNC-Alligator clip cables.

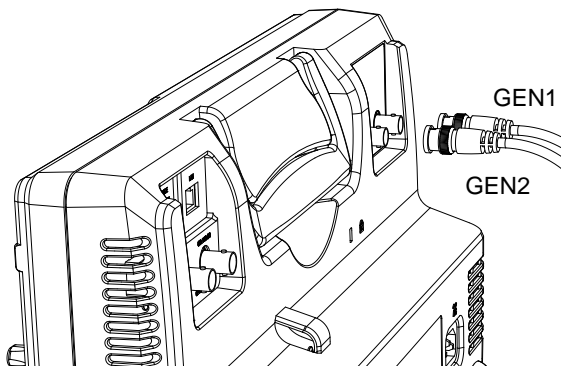

Output Setup

The Output Setup menu allows you to select a channel, to turn the output on or off for the selected channel, configure the load impedance and the phase of the output.

Select the Active Channel

- Background
- Before any operations can be performed on a channel it must first be selected.
-

- Panel Operation
1. Press the *Option* key.

Option



2. Press *AWG* from the bottom menu.

AWG



3. Press *Output Setup*.

Output
Setup

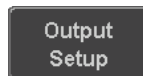

4. Press *Select* from the side menu and choose GEN1 or GEN2.

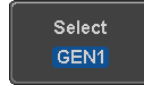

Turn the Output On for the Selected Channel

Background The output for each generator channel can be turned on or off independently.

- Panel Operation** 1. Press *Output* to toggle the selected channel on or off.

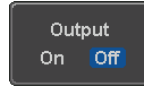

Setting the Load Impedance

Background The load impedance can be independently set for each generator channel.

- Panel Operation** 1. Press *Load* to toggle the impedance between 50Ω and High Z.



Setting the Phase

Background The output phase can only be set for the GEN1 output. GEN2 is always set to an output phase of 0°.

- Panel Operation** 1. Press *Phase* and use the variable knob to set the phase.



Phase -180° ~ 180°

- Reset Phase** 2. The phase can be reset by pressing *S_Phase*.

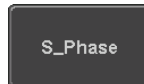

GEN1 and GEN2 Setup

The GEN1 Setup and GEN2 Setup selects the output waveform, waveform settings (amplitude, frequency, offset), modulation mode or allows you to create arbitrary waveforms.

Selecting a Waveform

Background The AWG option has 14 selectable waveforms, including a user-created arbitrary waveform. When using the modulation function, the waveform selected here is also used as the carrier wave.

Panel Operation

- From the AWG menu press *GEN1 Setup* or *GEN2 Setup* to select the waveform for generator 1 or generator 2, respectively.
 

OR

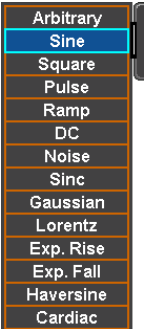
- Press *Waveform* from the bottom menu.
 
- From the side menu press the waveform soft-key and select a waveform using the variable knob.
 

Selectable waveforms Arbitrary, sine, square, pulse, ramp, DC, Noise, Sinc, Gaussian, Lorentz, Exp. Rise, Exp. Fall, Haversine, Cardiac.

Waveform Settings

Background The Waveform Settings sub menu selects the Frequency, amplitude and offset settings for currently selected waveform in the GEN1 or GEN2 Setup menu.

1. From the Waveform menu, press *Waveform Settings* from the side menu.

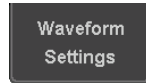

2. Press *Frequency* to set the frequency rate of the waveform.

Note: When *Frequency* is initially pressed the variable knob can be used to quick-select the frequency step-resolution. The variable knob can then be used to set the frequency in increments of the step resolution.

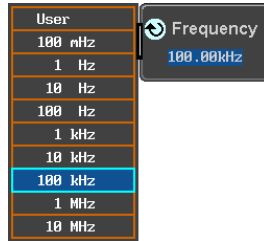

Range Arbitrary, Sine: 100mHz ~ 25MHz
 Square, Pulse: 100mHz ~ 15MHz
 Others: 100mHz ~ 1MHz

3. Press *Amplitude* to set the amplitude of the waveform.

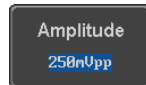



4. Use the Left and Right arrow keys to select a base unit and use the variable knob to increase the amplitude by that base unit, as shown in the Amplitude window.

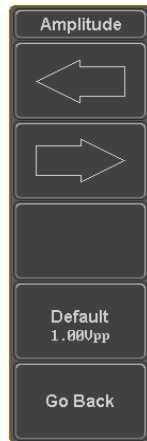
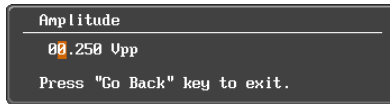

5. Default can be pressed to set the amplitude to 1.00Vpp.
6. Press Go Back to leave the menu.

Range 10mVpp to 2.5Vpp (Load:50Ω)
 20mVpp to 5Vpp (Load: High Z)

Default 1.00Vpp

Set the Offset

7. Press *Offset* to set the offset of the waveform.





- Use the Left and Right arrow keys to select a base unit and use the variable knob to increase the offset by that base unit, as shown in the Offset window.

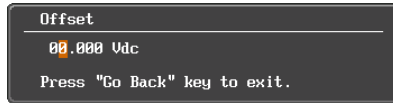

- Default can be pressed to set the Offset to 0.00Vdc.
- Press Go Back to leave the menu.

Range	-1.245 ~ +1.245 (Load: 50Ω)
	-2.49 ~ + 2.49 (Load: High Z)
Default	0.00Vdc

Exit Waveform Settings

- Press *Go Back* to exit the waveform settings.

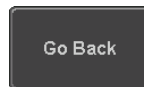

AM Modulation

Background Amplitude modulation can be used for either channel. All waveforms except Noise and DC can be used as the carrier wave. Sine, square, pulse, ramp and noise can be selected as the modulating waveform.

Example

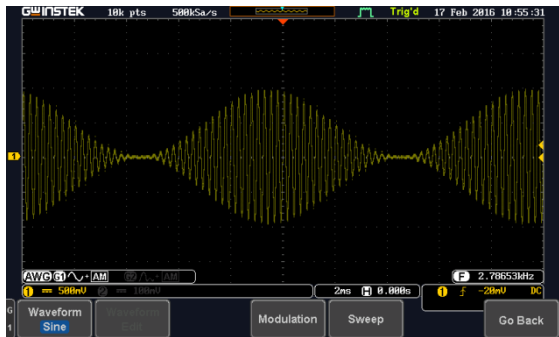

Panel Operation 1. Select the carrier waveform from the GEN1 Setup/GEN2 Setup menu:

Press *GEN1 Setup* or *GEN2 Setup* for generator 1 or generator 2, respectively.









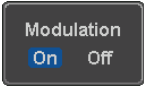

Press *Waveform* from the bottom menu.

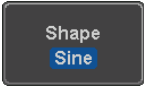

Select the waveform from the side menu. This will be the carrier wave.

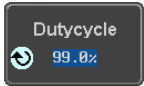
Carrier Waves Sine, square, pulse, ramp, sinc, gaussian, Lorentz, exp. rise, exp. fall, haversine, cardiac.

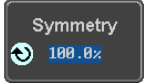
	2. Press the <i>Modulation</i> from the bottom menu.	
	3. From the side menu, turn <i>Modulation</i> on.	
	4. Press <i>AM</i> to select AM modulation and to enter the AM modulation setup menu.	
Set the Modulation Depth	5. Press <i>Depth</i> to set the modulation depth.	
	Depth 0.0% ~ 120.0%	
Modulation Frequency	6. Press <i>AM Freq</i> to set the modulation frequency.	
	Frequency 200kHz ~ 1Hz	
Shape	7. Press <i>Shape</i> to set the modulating wave shape.	
	Shape Sine, square, pulse, ramp, noise	
Phase (Sine wave only)	8. Press <i>Phase</i> to set the phase of the modulated wave (sine wave).	
	Phase -180.0° ~ 180.0°	
Duty Cycle (Pulse wave only)	9. Press <i>Duty Cycle</i> to set the duty cycle (pulse wave).	
	Duty Cycle 2.0 ~ 98%	

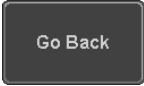
Symmetry (Ramp wave only)	10. Press <i>Symmetry</i> to set the symmetry (pulse wave).	
	Symmetry 0% ~ 100%	
Rate (Noise wave only)	11. Press <i>Rate</i> to set the rate (noise wave).	
	Noise 1kHz ~ 10MHz	
Exit AM Settings	12. Press <i>Go Back</i> to exit the AM settings.	

FM Modulation

Background Frequency modulation can be used for either channel. The carrier wave can only be sine, square and ramp waveforms. Sine, square, pulse, ramp and noise can be selected as the modulating waveform.

Example

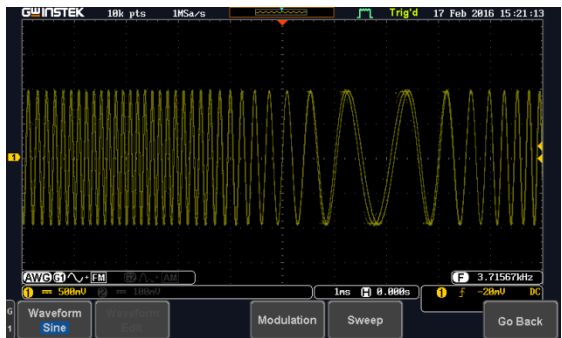

Panel Operation 1. Select the carrier waveform from the GEN1 Setup/GEN2 Setup menu:

Press *GEN1 Setup* or *GEN2 Setup* for generator 1 or generator 2, respectively.



Press *Waveform* from the bottom menu.



Select the waveform from the side menu. This will be the carrier wave.

Carrier Waves Sine, square, ramp

2. Press the *Modulation* from the bottom menu.



3. From the side menu, turn *Modulation* on.

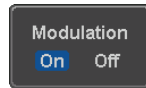

4. Press *FM* to select FM modulation and to enter the FM modulation setup menu.



Set the Frequency Deviation 5. Press *Freq Dev* to set the frequency deviation.



Deviation 12.5MHz ~ 0.1Hz

Modulation Frequency 6. Press *FM Freq* to set the modulation frequency.

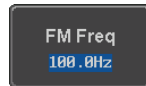



Frequency 200kHz ~ 1Hz

Shape 7. Press *Shape* to set the modulating wave shape.

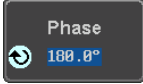

Shape Sine, square, pulse, ramp, noise

ARBITRARY WAVE GENERATOR

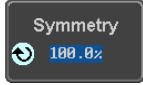
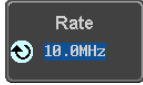
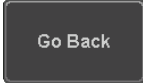
Phase (Sine wave only)	8. Press <i>Phase</i> to set the phase of the modulated wave (sine wave).	
	Phase -180.0° ~ 180.0°	
Duty Cycle (Pulse wave only)	9. Press <i>Duty Cycle</i> to set the duty cycle (pulse wave).	
	Dutycycle 1% ~ 99%	
Symmetry (Ramp wave only)	10. Press <i>Symmetry</i> to set the symmetry (ramp wave).	
	Symmetry 0% ~ 100%	
Rate (Noise wave only)	11. Press <i>Rate</i> to set the rate (noise wave).	
	Rate 1kHz ~ 10MHz	
Exit FM Settings	12. Press <i>Go Back</i> to exit the FM settings.	

FSK Modulation

Background	Frequency Shift Keying Modulation is used to shift the frequency output of the function generator between two preset frequencies (carrier frequency, hop frequency).
------------	--

Example

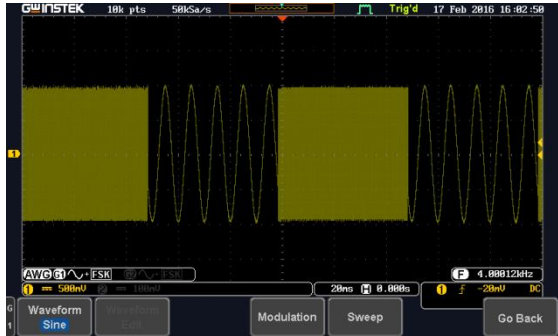

- Panel Operation
1. Select the carrier waveform from the GEN1 Setup/GEN2 Setup menu:

Press *GEN1 Setup* or *GEN2 Setup* for generator 1 or generator 2, respectively.



Press *Waveform* from the bottom menu.



Select the waveform from the side menu. This will be the carrier wave.

Carrier Waves Sine, square, ramp

2. Press the *Modulation* from the bottom menu.



3. From the side menu, turn *Modulation* on.

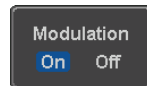

4. Press *FSK* to select FSK modulation and to enter the FSK modulation setup menu.



- | | | |
|-----------------------------|---|---|
| Set the Hop Freq | 5. Press <i>Hop Freq</i> to set the hop frequency. | <div style="border: 1px solid black; padding: 5px; display: inline-block;">Hop Freq
100.0Hz</div> |
| Hop Freq 25MHz ~ 0.1Hz | | |
| FSK Rate | 6. Press <i>FSK Rate</i> to set the rate at which the waveform switches from the carrier and hop frequency. | <div style="border: 1px solid black; padding: 5px; display: inline-block;">FSK Rate
10.0Hz</div> |
| FSK Rate 1Hz ~ 200kHz | | |
| Exit FSK Settings | 7. Press <i>Go Back</i> to exit the FSK settings. | <div style="border: 1px solid black; padding: 5px; display: inline-block;">Go Back</div> |

Sweep

Background The Sweep function can be used with sine, square and ramp waveforms for either channel. The function supports linear or logarithmic sweeping as well as up or down sweeping.

Example

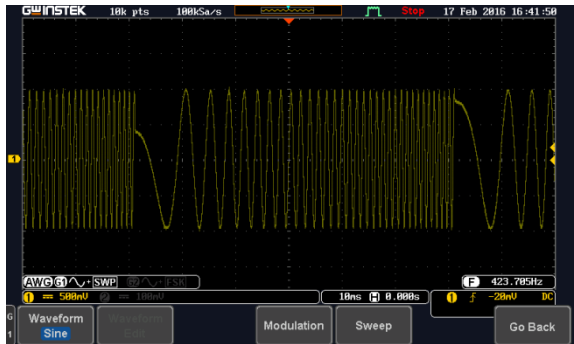

- Panel Operation** 1. Select the waveform from the GEN1 Setup/GEN2 Setup menu:

Press *GEN1 Setup* or *GEN2 Setup* for generator 1 or generator 2, respectively.



Press *Waveform* from the bottom menu.



Select the waveform from the side menu.

Sweep Waves Sine, square, ramp.

2. Press the *Sweep* from the bottom menu.

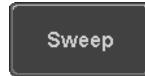

3. From the side menu, turn *Sweep* on.

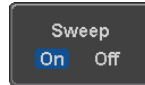

Type of Sweep

4. Press *Type* to set the sweep to linear or logarithmic.

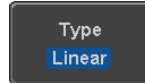

Type Linear, Log

Start and Stop Frequency

5. Press the *Start* or *Stop* soft-keys to set the start and stop frequency, respectively.

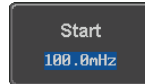

Start/Stop 25MHz ~ 0.1Hz



Note

To configure a up sweeping, set the start frequency at a lower value than the stop frequency. To configure a down sweeping, set the start frequency at a higher value than the stop frequency.

Center Frequency & Span

Alternatively the center frequency and span can be set instead of the start and stop frequencies.

6. Press *More 1 of 2*.



7. Press *Span* to set the frequency span of the sweep.

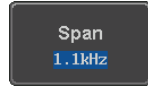

8. Press *Center* to set the center frequency for the configured span.

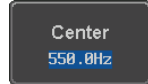

Span 25MHz ~ -25MHz
 Center 25MHz ~ 0.1Hz



Note

To configure a up sweeping, set the span with a positive frequency. To configure a down sweeping, set the span with a negative frequency.

Sweep Time

9. Press SWP Time to set how long the sweep takes to go from the start to the stop frequency.



Sweep time 5.0us ~ 10s

Manage Arbitrary Waveforms

The Arbitrary Waveform menus allow you to create, edit, recall and save arbitrary waveforms. The menus are accessible via the *Waveform Edit* button on the bottom menu once GEN1 or GEN2 has been setup with an arbitrary waveform.

Create New ARB Waveform

Background

The Create New menu is used to load an inbuilt waveform with a defined length in order to build the shape of the arbitrary waveform. Supported waveforms include: Sine, Square, Pulse, Ramp and Noise.

Example

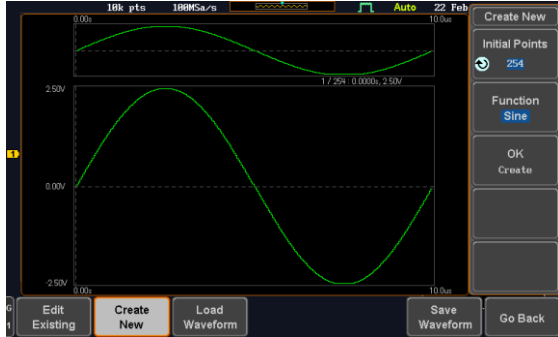

- Panel Operation
1. Select an arbitrary waveform from the GEN1 Setup/GEN2 Setup menu:

Press *GEN1 Setup* or *GEN2 Setup* for generator 1 or generator 2, respectively.



Press *Waveform* from the bottom menu.



Select *Arbitrary* from the side menu.

2. Press the *Waveform Edit* from the bottom menu.



3. From the bottom menu select *Create New*.

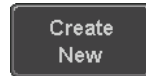

4. Press *Initial Points* to set the number of points for the waveform length.

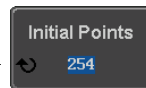

Initial Points 2 ~ 16384

5. Press *Function* to choose an inbuilt waveform :

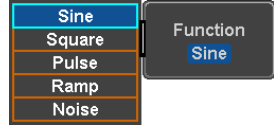

Function: Sine, Square, Pulse, Ramp, Noise

6. Press *OK Create* to create the arbitrary waveform shape.

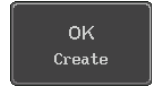

Edit an Existing ARB Waveform

Background Use the Edit Existing menu to edit a newly created waveform and further shape it according to your requirements. You can also use the Edit Existing menu for arbitrary waveforms that have been recalled (see Load Waveform page 212). There are two main options that can be used to edit waveforms: Normal Edit and Function Edit.

Editing Methods **Normal Edit:**
The Normal Edit function allows you to insert or delete points at any position on a waveform.

Function Edit:
The Function Edit function allows you to edit the waveforms in a number of different ways:

- **Point/Line:** Insert a point or horizontal line into the ARB waveform.
- **Diagonal:** Insert a diagonal line
- **Scale:** Scales the ARB waveform vertically.
- **Copy/Paste:** Copy or paste a section of the ARB waveform.
- **Clear:** Clears a section of the ARB waveform and replaces it with a 0V DC waveform.

Example

This box shows the editing window in relation to the full ARB waveform

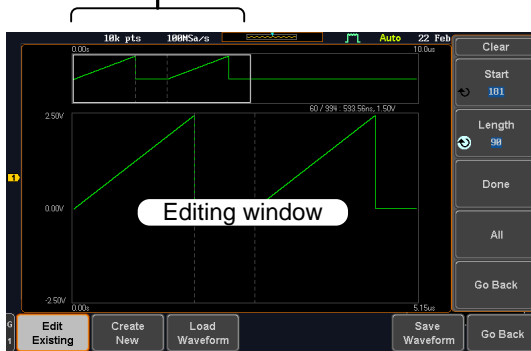

- Panel Operation
1. Select a waveform from the GEN1 Setup/GEN2 Setup menu:

Press *GEN1 Setup* or *GEN2 Setup* for generator 1 or generator 2, respectively.



Press *Waveform* from the bottom menu.



Select *Arbitrary* from the side menu.

2. Press the *Waveform Edit* from the bottom menu.



Edit Existing

3. From the bottom menu select *Edit Existing*.

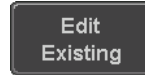

This will allow you to edit the ARB waveform that is currently loaded in memory. If no waveform has been loaded, a DC waveform is shown.

Normal Edit

4. Press *Normal Edit* to insert a point or delete a point from the waveform:

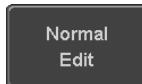

Insert Point:

To insert a point, you must first set the position of the point to be inserted.

- a. Press *Point* to set the x-axis position of the point.

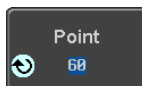

Point 1 ~ user-defined point position

- b. Press *Level* to set the amplitude of the point. The max/min amplitude depends on the waveform amplitude settings, see page 192.



Level ±1.25Vdc (Load: 50Ω)
 ±2.5Vdc (Load: High Z)

- c. Press *Insert Point*. The inserted point will increase the length of the waveform by one point.

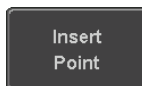

Delete Point:

- d. Press *Delete Point* to delete the point set with the “Point” soft-key.

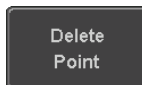

The overall length of the waveform will be shortened by one point.

Exit Normal Edit

5. Press *Go Back* to exit the Normal Edit.

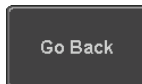

Function Edit

6. Press *Function Edit* to perform more advanced editing functions.



7. Press *Edit Method* to choose the editing method:



Edit Method: Point/Line
 Diagonal
 Scale
 Copy/Paste
 Clear

8. Press *Action* to begin using the selected editing method:

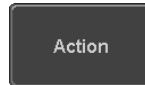

Point/Line:

- a. Press *Point/Level* once to select the point's X-axis start point.

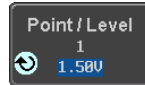

Press *Point/Level* again to select the amplitude (Level)

Point 1 ~ user-defined point position
 Level ±1.25Vdc (Load: 50Ω)
 ±2.5Vdc (Load: High Z)

- b. Press *Length* to set the length of the line.

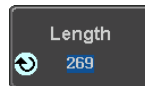

Length 0 ~ user-defined point length

- c. The *Adjustment* soft-key can be used to toggle the step resolution of the variable knob when editing values in this menu.

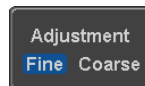

Adjustment Fine, Coarse

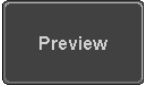
d. Press *Preview*. The desired edit will then be previewed on the screen. 

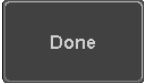
e. Press *Done* to confirm the edit, or press *Undo* to cancel. 

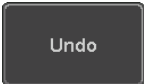

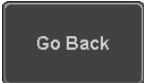
f. Press *Go Back* to go back to the previous menu. 

Diagonal:

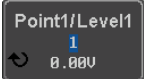
a. Press *Point1/Level1* once to select the point's X axis start point. 

Press *Point1/Level1* again to select the amplitude (Level) of the start point.

Point1 1 ~ user-defined point position
 Level1 ±1.25Vdc (Load: 50Ω)
 ±2.5Vdc (Load: High Z)

b. Press *Point2/Level2* once to select the point's X axis end point. 

Press *Point2/Level2* again to select the amplitude (Level) of the end point.

Point2 1 ~ user-defined point position

Level2 $\pm 1.25\text{Vdc}$ (Load: 50Ω)
 $\pm 2.5\text{Vdc}$ (Load: High Z)

- c. The *Adjustment* soft-key can be used to toggle the step resolution of the variable knob when editing values in this menu.

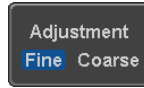

Adjustment Fine, Coarse

- d. Press *Preview*. The desired edit will then be previewed on the screen.

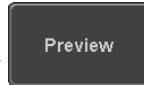

- e. Press *Done* to confirm the edit, or press *Undo* to cancel.

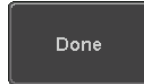

- f. Press *Go Back* to go back to the previous menu.

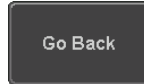

Scale:

- a. Press *Scale* and use the variable knob to set the scale of the waveform vertically.



Note: If the waveform exceeds the maximum amplitude it will be clipped.

Scale $0.1x \sim 10X$

- b. Press *Go Back* to go back to the previous menu.

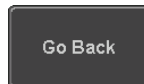

Copy/Paste:

- a. Press *Start* to set the start point of the section you want to copy.



- b. Press *Length* to set the size of the section you want to copy from the start point.



The copied section will be shown as a grey box on the display

Start 1 ~ user-defined point position

Length 1 ~ user defined point length

- c. Press *Paste To* to choose where the selected section is copied to.

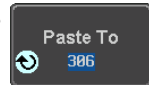

Paste To 1 ~ user defined point position

- d. Press *Preview*. The desired edit will then be previewed on the screen. The pasted section will be shown as a yellow box on the screen.

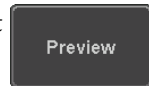

- e. Press *Done* to confirm the edit, or press *Undo* to cancel.

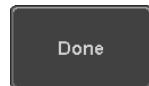

- f. Press *Go Back* to go back to the previous menu.

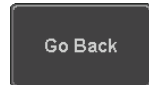

Clear Section:

- a. Press *Start* to set the start point of the section you want to clear.



Press *Length* to set the size of the section you want to clear.



Start 1 ~ user-defined point position

Length 1 ~ user-defined point length

b. Press *Done* to clear the selected section.

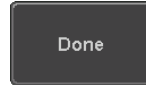

c. Alternatively, press *All* to clear the entire waveform from the screen.



d. Press *Go Back* to go back to the previous menu.

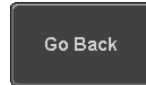

Load ARB Waveform

Background ARB waveforms can be loaded from internal memory or from an external USB storage.

Panel Operation 1. Select a waveform from the GEN1 Setup/GEN2 Setup menu:

Press *GEN1 Setup* or *GEN2 Setup* for generator 1 or generator 2, respectively.



Press *Waveform* from the bottom menu.

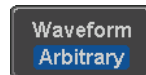

Select *Arbitrary* from the side menu.

2. Press *Waveform Edit* from the bottom menu.



3. From the bottom menu select *Load Waveform*.



4. To load a file from one of the internal memory slots, press *From* to choose the ARB waveform to load:

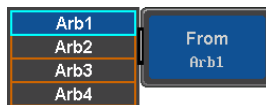

ARB: Arb1, Arb2, Arb3, Arb4

5. To load a file from an external USB or from the internal flash memory, press *From File*.

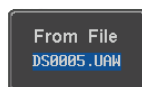

The last file that was saved to USB or the internal flash memory will be displayed in the icon.

6. To recall the displayed file, press *Recall Now*.

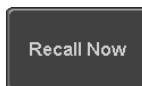

7. Alternatively, press *File Utilities*.

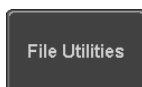

Use the Variable knob to select the desired ARB waveform.

Press the *Select* key to load the selected ARB waveform in the file utilities screen.



Press *File Utilities* to manage the files on the internal disk or an inserted USB disk. See page 303 for details.

Save ARB Waveform

Background ARB waveforms can be saved to internal memory or to an external USB storage.

Panel Operation 1. Select a waveform from the GEN1 Setup/GEN2 Setup menu:

Press *GEN1 Setup* or *GEN2 Setup* for generator 1 or generator 2, respectively.



Press *Waveform* from the bottom menu.



Select *Arbitrary* from the side menu.

2. Press *Waveform Edit* from the bottom menu.



3. From the bottom menu select *Save Waveform*.



4. To save to one of the internal memory slots, press *To* to choose the ARB waveform to save:

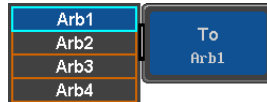

ARB: Arb1, Arb2, Arb3, Arb4

Press *Save* to save the waveform to the selected memory slot, Arb1, Arb2, Arb3 or Arb4.

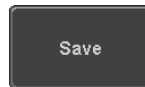

5. Alternatively, to save to a USB drive or to the internal flash memory, press *To File*.

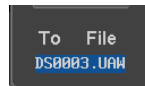

6. To save the selected file, press *Save* waveform.

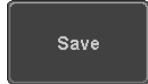

7. You will automatically be taken to a file utility where you will be able to edit the name of the file.

8. To edit the file name, use the *Variable* knob to highlight a character.



Press *Enter Character* or the *Select* key to select a number or letter.

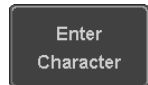

Press *Back Space* to delete a character.



9. Press *Save Now* to save the file.

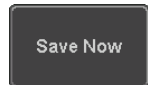

Note: Pressing *Cancel* will cancel the save operation and return you to the Save Waveform menu.

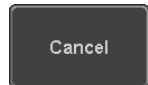

After *Save Now* has been pressed the file will be saved.



Note

The file will not be saved if the power is turned off or the USB drive is taken out before the message ends.

File Utility Alternatively, to edit the internal memory or the USB flash drive contents (create/ delete/ rename files and folders) or to edit the default file path, press *File Utilities* from the side menu. See the user manual for details



Coupling and tracking waveforms settings

Background GEN1 and GEN2 waveforms can be coupled in terms of frequency and/or amplitude. Similarly, waveform settings can also be tracked and be duplicated from one waveform to the other.

Panel Operation 1. From the bottom menu of the AWG menu:

Press *UTIL* to enter the Utility menu.



You can press on the *Preset* button from the side menu to reset both wave generators to a 0V DC waveform.



2. Press *Dual Chan* from the side menu to enter the coupling and tracking menus.



Tracking settings 3. From the side menu press *Tracking* to set the tracking mode to ON or OFF.



Tracking: ON, OFF

When Tracking is ON, all parameters set to one waveform will be copied to the other one and vice-versa.



Note

Tracking mode cannot be used together with the Frequency or Amplitude Coupling. Setting the Tracking mode to ON will disable any Coupling settings.

Frequency coupling

4. From the side menu press *Freq Cpl*

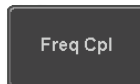

5. Press *Freq Cpl Type* to set the type of frequency coupling.



Freq Cpl Type: OFF, Offset, Ratio

Frequency from both generated waveforms can be coupled with a fixed offset or with a constant ratio.

6. Select *Offset* from the *Freq Cpl Type* menu and press *Offset* on the side menu to configure the offset of the frequency coupling.

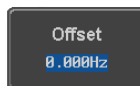

7. Use the Left and Right arrow keys to select a base unit and use the variable knob to increase or decrease the offset by that base unit, as shown in the Offset window.

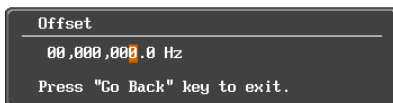

8. Default can be pressed to set the Offset to 0.0Hz.
9. Press Go Back to leave the menu.

10. Select *Ratio* from the *Freq Cpl Type* menu and press *Ratio* on the side menu to configure the ratio of the frequency coupling.



11. Use the Left and Right arrow keys to select a base unit and use the variable knob to increase or decrease the ratio by that base unit, as shown in the Ratio window.

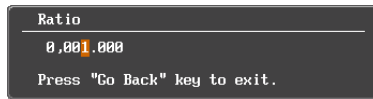

12. Default can be pressed to set the Ratio to 1.000.

13. Press *Go Back* to leave the menu.

14. Press again *Go Back* to leave the menu Frequency Coupling menu.

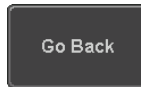

Note Frequency Coupling cannot be set if Tracking is ON. Configuring Frequency Coupling parameters will disable the Tracking mode.

Amplitude coupling

15. Press *Ampl Cpl* to set the amplitude coupling to ON or OFF.



Ampl Cpl: OFF, ON

When set to ON, amplitude from both generated waveforms will be duplicated from one to the other one.



Note

Amplitude Coupling cannot be set if Tracking is ON. Configuring Amplitude Coupling will disable the Tracking mode.

Reset the phase

16. You can also reset the phase to 0° between the two waveforms by pressing *S_Phase*.



S_Phase

SPECTRUM ANALYZER

Spectrum Analyzer operation	221
Overview	221
Display Overview	222
Connections	224
Configuration	224
Selecting the source	224
Setting the trace mode options (Trace type)	225
Setting the Detection Method	228
Configuring the Frequencies and Span	229
Configuring the Bandwidth	233
Configuring the Amplitude	234
Measurement	236
Using the Search function	236
Using the Cursors	237

Spectrum Analyzer operation

Overview

Background	The Spectrum Analyzer is a real-time spectrum analyzer specially designed for the MDO-2000EG/2000EX. It conveniently allows users to analyze the signal in the frequency domain.
Windows	Hanning, Rectangular, Hamming, Blackman
Frequency range	DC to 500MHz Max (Maximum frequency to 500MHz uncalibrated)
Spin	1kHz to 500MHz Max.
Resolution bandwidth	1Hz to 500kHz Max.
Functions	Compatible with the search and cursor functions for accurate measurement in the frequency domain.

Display Overview

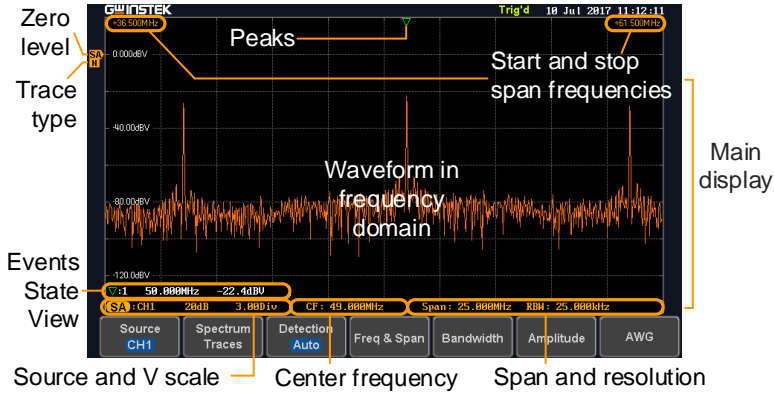

Main display

The Spectrum Analyzer main display can show various spectrum traces of the selected analog source channel, such as the normal, max-hold, min-hold and averaged trace. The start and stop frequency of the span are displayed at both top sides. The remaining frequency span information is displayed at the bottom as well as the vertical scale. The zero level is shown for reference on the Y axis on the left. When the search function is enabled, frequency peaks will be detected and summarized in the Events State View window at the bottom left of the display.

Frequency domain information

+36.500MHz Start

frequency (shown on the upper left corner of the main spectrum display)

+61.500MHz Stop

frequency (shown on the upper right corner of the main spectrum display)

CF : 49.000MHz

Center frequency of the span

Span : 25.000MHz

Width of the span

RBW : 25.000kHz

Resolution bandwidth

Vertical scale information

SP:CH2 Active source channel for the spectrum analyzer

20dB Vertical scale per one division

2.00Div Zero level position

SP N Shows the zero position along the Y-axis (SP) and the type of trace (N = Normal)

Peaks

▽ Peak mark

▽ Current active peak

▽: 2 Active peak marker

Overall: 3 Total number of peaks detected (according to the search function parameters).

Connections

Background The Spectrum Analyzer uses the analog channel inputs of the MDO-2000EG/2000EX.

Connection 1. Connect the desired signal source to one of the analog channel input of the DSO using BNC connectors (illustration below with a 4-channel MDO-2000EG/2000EX series model).

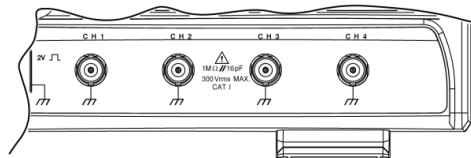

Configuration

Setting up a spectrum trace can be done by following the subsequent steps: selecting the source, tuning the trace with its associated detection options, configuring the frequencies and span, configuring the window type and the frequency resolution and lastly configuring the vertical scale.

Selecting the source

Background Before any visualization or measurement can be performed on the spectrum analyzer, it must first be associated with a source.

Panel Operation 1. Press the *Option* key.

Option



2. Press *Spectrum Analyzer* from the bottom menu.

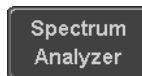

3. Press *Source* from the bottom menu.



4. Press *Source* from the side menu and choose a source.



Range CH1 ~ CH4 for 4-channel models
 CH1 ~ CH2 for 2-channel models

5. Press *Quit* from the side menu to exit the spectrum analyzer function.

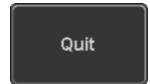

Setting the trace mode options (Trace type)

Background Trace options determine how the trace data is stored or manipulated before being displayed. The Spectrum Analyzer updates the trace according to the type of trace.

Definitions

Normal: the Spectrum Analyzer continuously updates the display with each sweep.

Max/Min Hold: the maximum/minimum points are maintained for the selected trace. The trace points are updated each sweep if a new maximum/minimum point is found.

Average: this mode averages the trace for a user-defined number of times before it is displayed. This type of trace smoothes the noise level, but it is slower to update.

Example

Normal trace:

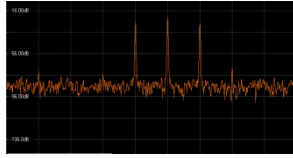

MaxHold:

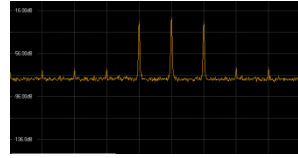

Average:

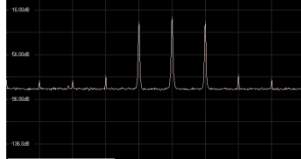

MinHold:

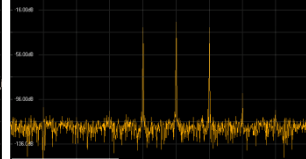

Panel Operation

1. Press the *Option* key, and the *Spectrum Analyzer* button to enter the Spectrum Analyzer menu.



2. Press the *Spectrum Traces* button from the bottom menu.

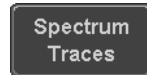

3. From the side menu, press once on the *Normal* button to toggle this trace option to *On*. Press again to toggle it to *Off*.

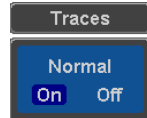

4. From the side menu, press once on the *MaxHold* button to toggle this trace option to *On*. Press again to toggle it to *Off*.



5. From the side menu, press once on the *MinHold* button to toggle this trace option to *On*. Press again to toggle it to *Off*.



- From the side menu, press once on the *Average* button to toggle this trace option to *On*. Use the variable knob to change the number of sweeps the average will be based on. Press again to toggle it to *Off*.
Range 2 ~ 256

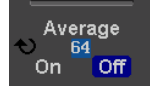

- Press the *Reset Spectrum Traces* button to clear all current active traces on the screen and then restart the spectrum calculation process.

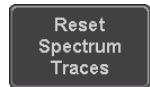

The four different trace types can be activated at the same time, allowing a quick comparison for the maximum, minimum and averaged spectrum magnitude of the underlying signal.



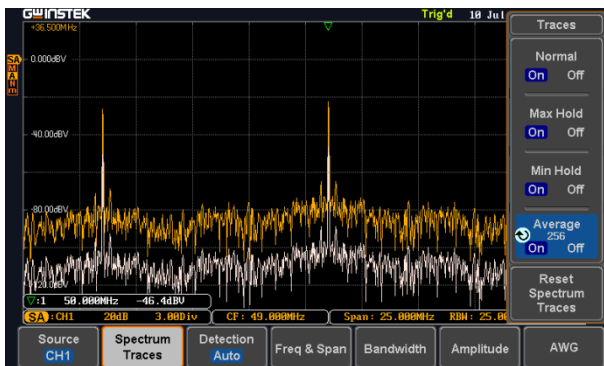

Example

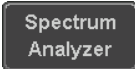

Setting the Detection Method

Background Each time the Spectrum Analyzer samples data, a number of samples are usually taken for each point to display, known as a sample bucket. The actual value of each point is determined by the detection method.

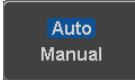
Each trace type (Normal, Max and Min Hold, Average) can use a different detection method.

- Panel Operation**
1. Press the *Option* key, and the *Spectrum Analyzer* button to enter the Spectrum Analyzer menu.
 

 2. Press the *Detection* button from the bottom menu.
 
 3. By default, the detection method is set to *Auto*. When selected, the analyzer automatically chooses a detection method suitable for each type of trace.
 

 4. Press the button *Auto/Manual* once to toggle the detection method to *Manual* and be able to fine tune the detection method for each type of trace. Press the *Auto/Manual* button once more to toggle it back to *Auto*.
 

5. Press on the *Normal Trace* button to see a list of detection options. Use the variable knob and the *Select* key to select one.

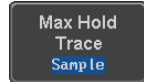

6. Repeat the same operation for the *Max Hold Trace* button.



7. Repeat the same operation for the *Min Hold Trace* button.



8. Repeat the same operation for the *Average Trace* button.

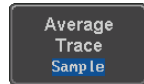

Configuring the Frequencies and Span

Center Frequency The Center Frequency function sets the center frequency. The display will be centered on this frequency.

- Panel Operation**
1. Press the *Option* key, and the *Spectrum Analyzer* button to enter the Spectrum Analyzer menu.



2. Press the *Freq & Span* button to enter the frequencies and span menu.

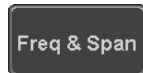

3. Press the *Center* button to display a list of frequencies step-resolution.

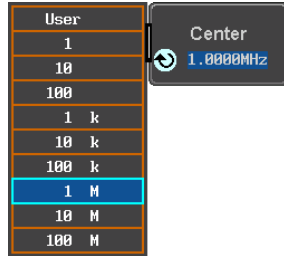

The variable knob can be used to select one. Press again on the *Center* button; the variable knob can now be used to set the frequency in increments of the chosen step resolution.

4. Alternatively, select *User* from the list of frequency or press the *Select* key. Use the arrows to select a base unit and the variable knob to further tune the selected base unit.

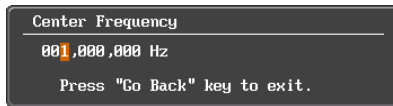
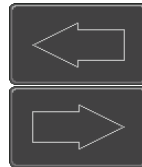

Press *Go Back* to return to the previous menu and validate the user-defined value.

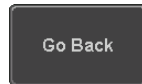

Range 0Hz ~ 500MHz

Span

The Span function sets the frequency range of the sweep. The sweep will be centered around the center frequency.

- Panel Operation 5. Press the *Span* button to display a list of frequencies step-resolution.

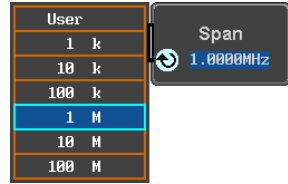

The variable knob can be used to select one. Press again on the *Span* button; the variable knob can now be used to set the frequency in increments of the chosen step resolution.

6. Alternatively, select *User* from the list of frequency or press the *Select* key. Use the arrows to select a base unit and the variable knob to further tune the selected base unit.

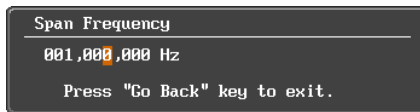
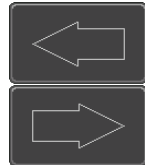

Press *Go Back* to return to the previous menu and validate the user-defined value.

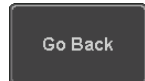

Range 1,000Hz ~ 500MHz

Start and Stop Frequencies The Start and Stop frequencies can also be used to specify the span frequency.



The Start and Stop frequencies are automatically adjusted when configuring the Center and the Span. Conversely, configuring the Start and Stop frequencies will automatically configure the Center and the Span.

The Stop frequency must always be higher than the Start frequency. As a consequence, when one crosses the other's value, the Start or Stop frequency will automatically be adjusted to the next highest/smallest step.

- Panel Operation 7. Press the *Start* or *Stop* button to display a list of frequencies step-resolution.

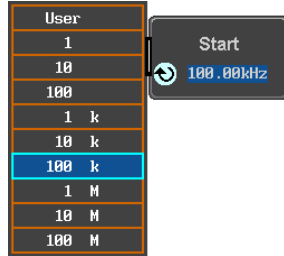

The variable knob can be used to select one. Press again on the *Start* or *Stop* button; the variable knob can now be used to set the frequency in increments of the chosen step resolution.

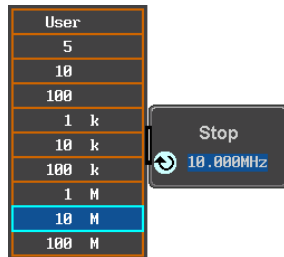

8. Alternatively, select *User* from the list of frequency or press the *Select* key. Use the arrows to select a base unit and the variable knob to further tune the selected base unit.

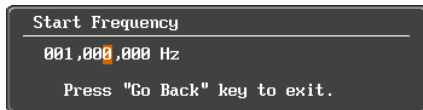
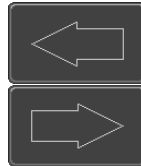

Press *Go Back* to return to the previous menu and validate the user-defined value.

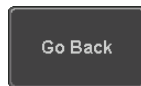

Range Start: -250MHz ~ 499.995MHz







Stop: 500Hz ~ 750MHz

Span: 1kHz ~ 500MHz

Peak to center	Pressing this button will set the frequency location of the spectrum peak as the new center frequency of the Spectrum Analyzer.	
----------------	---	---

Configuring the Bandwidth

Background	The bandwidth menu gives the possibility of configuring the resolution bandwidth as well as the type of window used for the spectral analysis.
------------	--

Panel Operation	<ol style="list-style-type: none"> 1. Press the <i>Option</i> key, and the <i>Spectrum Analyzer</i> button to enter the Spectrum Analyzer menu. 	<p>Option</p>  
	<ol style="list-style-type: none"> 2. Press the <i>Bandwidth</i> button to enter the bandwidth menu. 	
	<ol style="list-style-type: none"> 3. The resolution bandwidth can be set automatically according to a configurable ratio defined between the span and the frequency resolution. To choose that option, set the <i>RBW Mode</i> button to <i>Auto</i>, press on the <i>Span: RBW</i> button and tune the ratio using the variable knob. 	 
	<p>Range 5,000:1 ~ 1,000:1</p>	
	<ol style="list-style-type: none"> 4. Alternatively, set the <i>RBW. Mode</i> button to <i>Manual</i> to manually configure the frequency resolution. 	

5. Press the *RBW* button to select the RBW frequency. The variable knob can be used to select.



Window type

The type of window used for spectrum analysis can be chosen. Each window type is characterized by making a tradeoff between the frequency resolution and the amplitude accuracy. Please see the note below.

6. Press the *Window* button and change the window type using the variable knob. Press again the *Window* button to confirm the change.

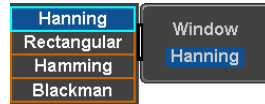

Note

Hanning and Hamming windows are both good to analyze periodic signals. The rectangular window is more suitable for single shot phenomenon. The Blackman window is most suitable for amplitude measurement on periodic signals. Please refer to the *MDO-2000EG/2000EX User Manual*, Math operations, *FFT Overview* for more details.

Configuring the Amplitude

Background

The vertical scale and the zero reference position can be configured in this menu.

Panel Operation

1. Press the *Option* key, and the *Spectrum Analyzer* button to enter the Spectrum Analyzer menu.



2. Press the *Amplitude* button to enter the vertical scale menu.



3. Choose a vertical unit by toggling the *Vertical Units* button to *dBV RMS*, *Linear RMS* or *dBm* using the variable knob.

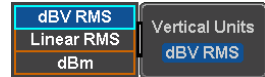

Note

When the setting unit is dBm, connect a 50 Ohm feed through termination on BNC.

4. You can define the scale of the vertical axis by pressing on the *Unit/div* button and using the variable knob.

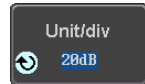

Range 1dB ~ 20dB (dBV RMS, dBm)
 2mV ~ 1kV (Linear RMS)

5. You can define the zero level position by pressing on the *Position* button and using the variable knob.



Range -12.00 ~ 12.00 Div

6. AWG fast switch button. This button is used for user to observe the AWG waveform change easily in the spectrum after changing waveform parameters.



Measurement

The Spectrum Analyzer of the MDO-2000EG/2000EX is compatible with a certain number of measurement tools such as the search function and the use of cursors, enabling detailed analysis of the signal characteristics in the frequency domain.

Using the Search function

Background When the Spectrum Analyzer is on, pressing the *Search* key and turning on the Search function will automatically pre-configure the *Search Type* and the *Source* (respectively set to *SP Peak* and *SP*) in order to search for spectrum peaks. Please also note that it is not possible to search for spectrum peaks if the Spectrum Analyzer Option is not on.

Panel Operation 1. When the Spectrum Analyzer is on, press the Search key.



2. Press the *Search* button from the bottom menu to turn the Search function on.

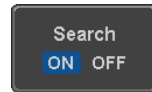

3. Configure the Search Method by pressing the *Method* button from the bottom menu and choose between two methods:



Max Peak: search for a defined number of peaks.



Threshold: search for peaks above a defined threshold level.

4. You can configure the Event state display by toggling the State Info button either to Mark or to Peak.

Mark: displays the overall number of peaks and the current active peak.



Peak: gives frequency and level details of the current active peak.



5. Press on the Peak Table button from the bottom menu to examine all the searched spectrum peaks in a tabulated form or save it as files on an external USB drive.



Note

For more details about the Search function, please refer to the *MDO-2000EG/2000EX User Manual, Search* chapter.

Using the Cursors

Background Horizontal and vertical cursors can be used together with the Spectrum Analyzer.

Panel Operation 1. When the Spectrum Analyzer is on, press the cursor key.



2. Move the horizontal cursors along the trace to perform accurate measurement of frequency and level. Use the horizontal and vertical cursors together to further measure points of interest in both absolute and delta values.

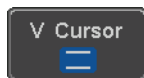
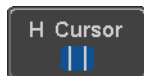



Note

For more details about the *cursor* function, please refer to the *MDO-2000EG/2000EX User Manual*, *Cursor* chapter.

Use the Save / Recall menu to save the spectrum data as a CSV file in SA mode, but you can't recall the file to the screen.

DMM

DMM function	240
Accessing the Digital Multimeter.....	240
DMM display overview.....	241
AC/DC Voltage Measurement	242
Current Measurement	243
Resistance Measurement.....	244
Diode Measurement	245
Continuity Measurement	246
Temperature Measurement	247

DMM function

The DMM function can be used simultaneously with the DSO function. The DMM function is a basic digital multimeter.

Accessing the Digital Multimeter

- Panel Operation 1. Press the *Option* key. The following diagram will appear on the display.

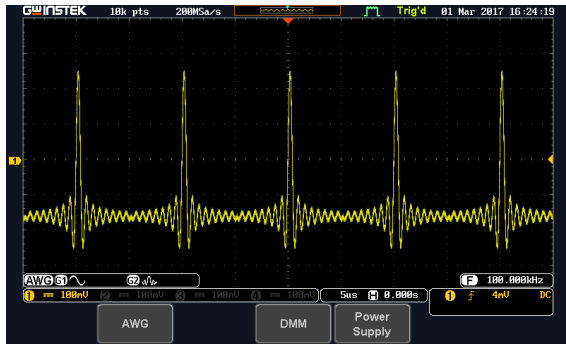

2. Press the *DMM* button from the bottom menu. The following diagram will appear on the display.

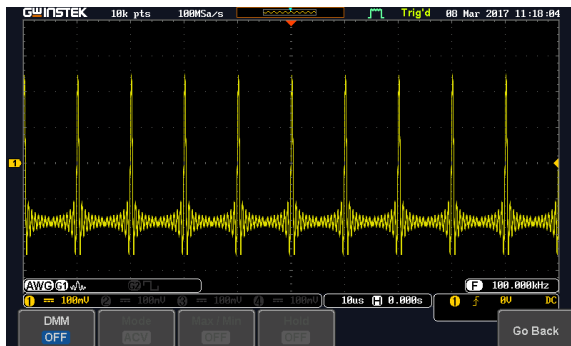

3. Press *DMM* button from the bottom menu to turn on the DMM function. You can select ACV, DCV, ACmV, DCmV, ACmA, DCmA, ACA, DCA, Ohms, Diode, Continuity and Temperature measurement from the DMM menu.
4. Press the *Max/Min* button to display the measured maximum and minimum values
5. Press the *Hold* button to keep the current measurement results.

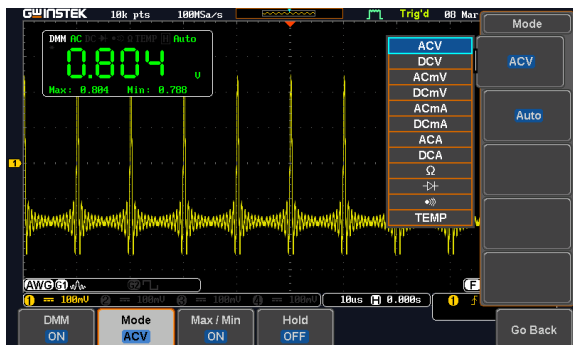

DMM display overview

The DMM display will show the measurement mode, max, min and current measurement.

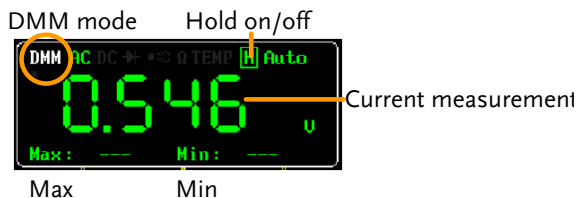

AC/DC Voltage Measurement

Background The MDO-2000EG/2000EX series can measure up to 600V (CAT II) or 300V (CAT III).

Connection

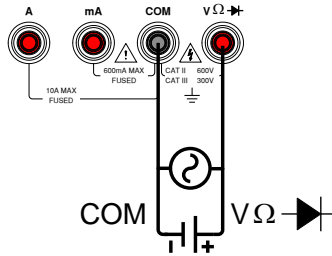

Note

To prevent the internal circuits from burning out, the unit will prevent you from switching voltage ranges during measurement when the input is greater than 10V. To switch ranges, first disconnect the probes from the DUT.

Steps

1. From the multimeter settings choose ACV, ACmV, DCV or DCmV.

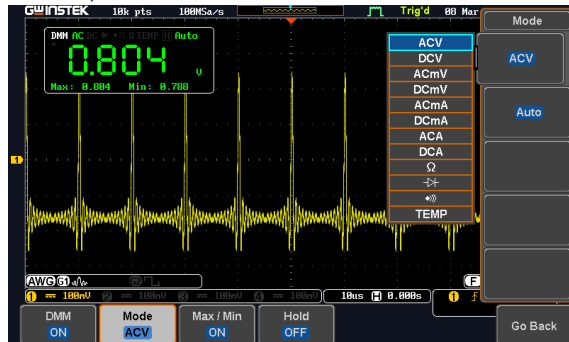

- Use the *Variable* knob to select the required measurement and press the *Select* key to confirm.

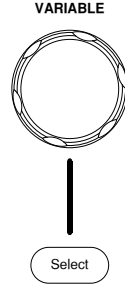

Current Measurement

Background The GDS-200/300 can measure AC and DC current from two input terminals, depending on the current range. There is a 10A input for $I \leq 10A$, and a mA terminal for $I \leq 600mA$.



Note

Ensure that no more than 600mA is input into the mA port. Failure to do so will blow the fuse.

Connection

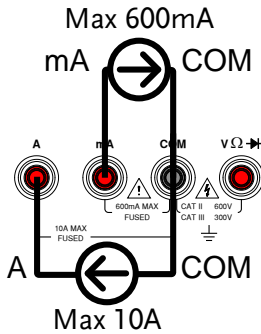

Steps

1. From the multimeter settings choose ACA, ACmA, DCA or DCmA. Ensure that no more than the 600mA is input into the mA port.

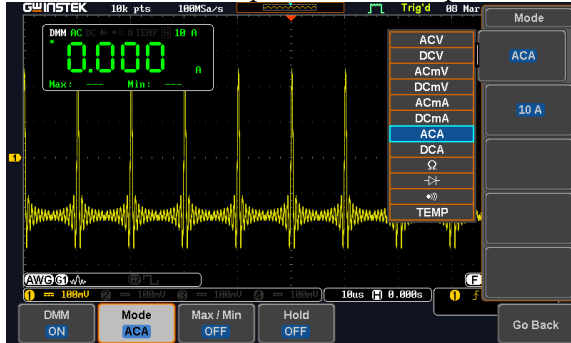

2. Use the *Variable* knob to select the required measurement and press the *Select* key to confirm.

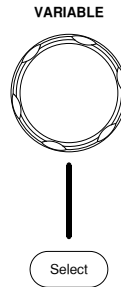

Resistance Measurement

Background

The GDS-200/300 can measure resistance up to 4 counts.

Connection

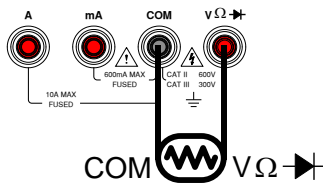

Steps

1. From the multimeter settings choose the resistance measurement.

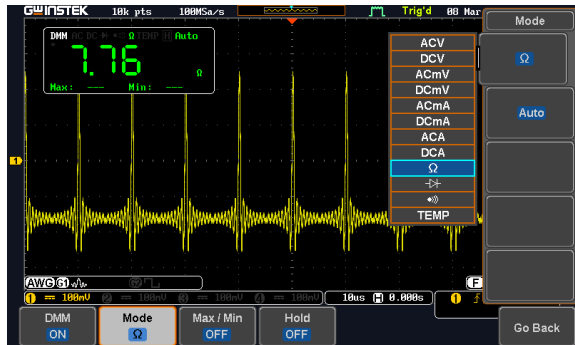

2. Use the *Variable* knob to select the required measurement and press the *Select* key to confirm.

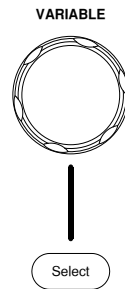

Diode Measurement

Background

The diode test checks the forward bias characteristics of a diode by running a constant forward bias current through the DUT and measuring the forward voltage drop.



Ensure the diode polarity is correct before performing the diode measurement.

Connection

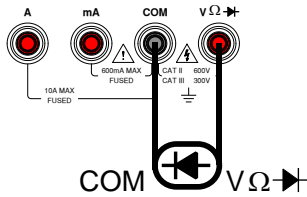

Steps

1. From the multimeter settings choose the diode measurement.

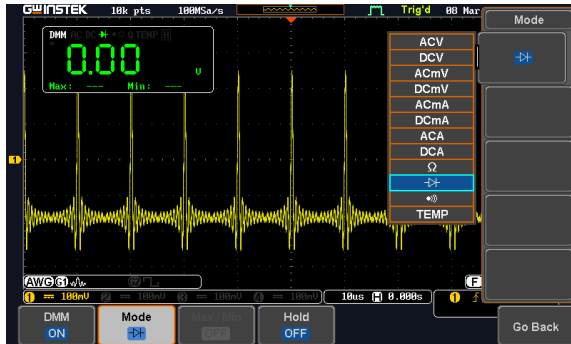

2. Use the *Variable* knob to select the required measurement and press the *Select* key to confirm.

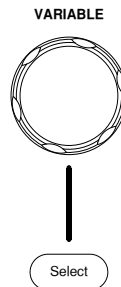

Continuity Measurement

Background

The continuity test checks that the resistance in the DUT is low enough to be considered continuous (of a conductive nature). The continuity threshold level is set to $<15\Omega$.

Connection

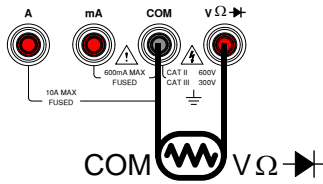

Steps

1. From the multimeter settings choose the continuity measurement

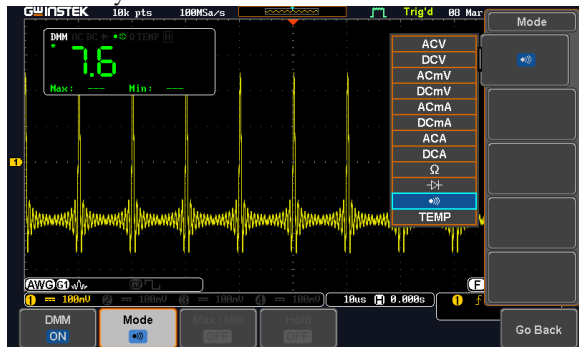

2. Use the *Variable* knob to select the required measurement and press the *Select* key to confirm.

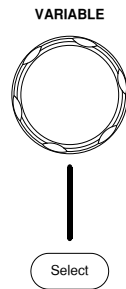

Temperature Measurement

Background

The MDO-2000EG/2000EX series can measure temperature using a thermocouple. To measure temperature, the DMM accepts a thermocouple input and calculates the temperature from the voltage fluctuation. The thermocouple type is taken into consideration.

Connection

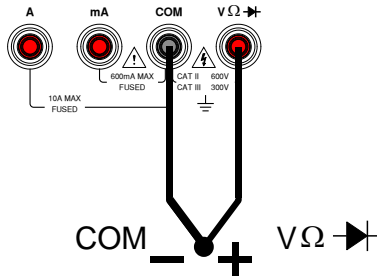

Steps

1. From the multimeter settings choose the temperature measurement.

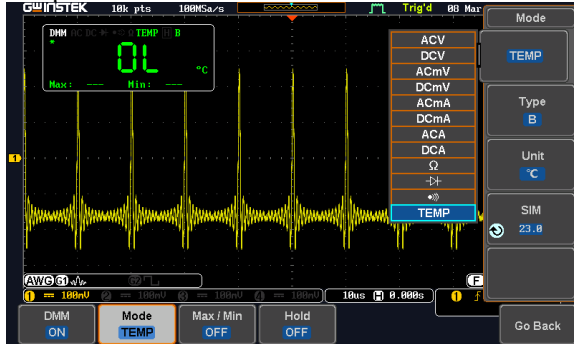

2. Select the thermocouple type. Thermocouple = B E, J, K, N, R, S, T
3. Pressing the Unit button will toggle between °C and °F.
4. SIM is the current ambient temperature setting, ranging from 0.00 to 50.0.

 Note

Please see the specifications on page 340 for the thermocouple specifications.

P OWER SUPPLY

Power supply function	250
Accessing the Power Supply	250
Set up the Power Supply.....	252

- Press the *Power Supply* button from the bottom menu. The following diagram will appear on the display.

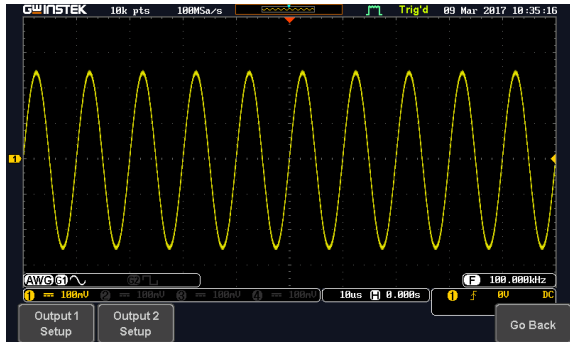



- Select *Output setup 1* or *Output setup 2* button to set and turn on the power supply. For example, press the *Output setup 1* button. The following diagram will appear on the display.

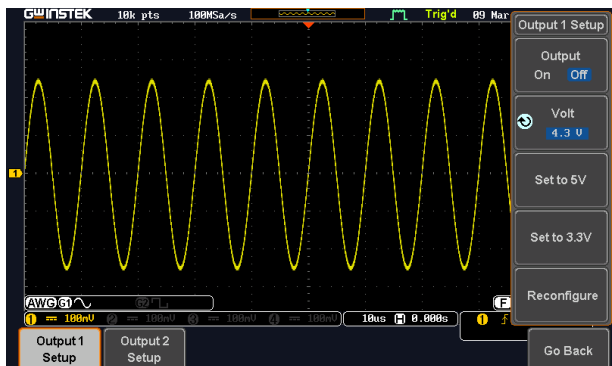

or

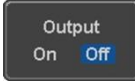
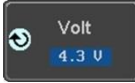
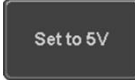

Set up the Power Supply

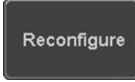
- Panel Operation
1. Set the output on or off
Press the *Output On/off* button to turn on off the power supply.
A rectangular button with a dark background. The word "Output" is at the top. Below it, "On" is on the left and "Off" is on the right, with "Off" highlighted in blue.
 2. Select output voltage range
Press the *Volt* button to select output continuously adjustable voltage from 1V to 5V (0.1 step)
A rectangular button with a dark background. It has a circular arrow icon on the left. The word "Volt" is at the top, and "4.3 V" is displayed in blue below it.
 3. Set to 5V
Press the *Set to 5V* button to directly set the output voltage to 5V.
A rectangular button with a dark background and the text "Set to 5V" in white.
 4. Set to 3.3V
Press the *Set to 3.3V* button to directly set the output voltage to 3.3V.
A rectangular button with a dark background and the text "Set to 3.3V" in white.
 5. When output is more than 1A or short circuit, OCP will be directly turned on. Press the *Reconfigure* button to reset and return to normal output.
A rectangular button with a dark background and the text "Reconfigure" in white.

AAPPLICATIONS

Introduction	254
Overview	254
Running Applications.....	255
Go-NoGo application.....	256
DVM application.....	261
Data Log application	263
Digital Filter application	265
Mask application	267
Select the source channel.....	267
Configure the mask violation.....	268
Auto Mask.....	269
User Defined Mask / Create Mask.....	272
User-defined Mask File Format	275

Introduction

Overview

Background	<p>The Application (APP) function allows different software applications to be run. The MDO-2000EG/2000EX comes pre-installed with a number of apps, as described below. Please see your local GW Instek distributor for the latest information on new apps.</p>	
Included Applications	Go/No-Go	<p>The Go/No-Go application can be used to set threshold boundaries for input signals. Go/No-Go tests to see if a waveform will fit inside a user-specified maximum and minimum amplitude boundary (template).</p>
	DVM	<p>The DVM application displays a digital voltage meter readout that floats on the top left-hand side of the screen.</p>
	Data Log	<p>The Data Log app will log waveform data and/or screenshots at set intervals for set duration of time.</p>
	Digital Filter	<p>Adds a digital low, high or band pass filter to any of the input channels. Each filter can have a user-defined cutoff frequency set.</p>
	Mask	<p>Create shape templates for signal comparison.</p>

Mount Remote Disk This app allows the scope to mount a network share drive.

Demo The Demo app, when combined with the GDB-03 demo board, allows the scope to trigger a number of different signals from the demo board.

Running Applications

Background The MDO-2000EG/2000EX comes pre-installed with a number of apps which can be activated from a dedicated menu.

Panel Operation 1. Press the *APP* key.



2. Press *APP* from the bottom menu.



3. Scroll through each application using the *Variable* knob.

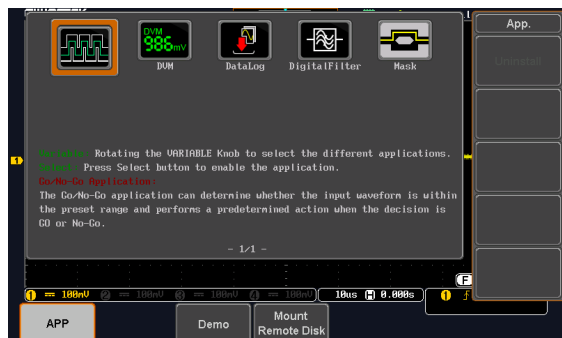

4. Select an application by pressing the *Select* key twice.

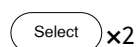

Go-NoGo application

Background

The Go-NoGo test checks if a waveform fits inside a user-specified maximum and minimum boundary. Boundary templates are automatically created from a source channel. Boundary tolerances and violation conditions can be set.

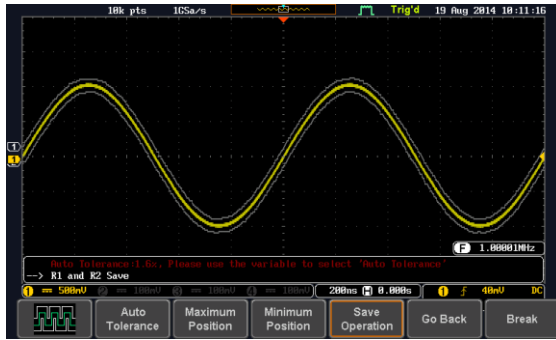

Choose the Go_NoGo application from the APP menu. See page 255.

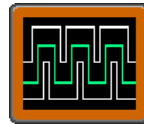

Set Go-NoGo Conditions

Select the Go-NoGo conditions (NG When) and actions when a Go-NoGo condition has been met (Violating).



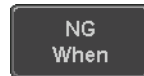





1. Press *NG When* from the bottom menu and select the NoGo conditions:

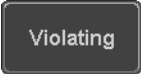

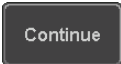
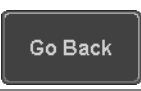
Enter: Sets the NoGo condition to when the input signal stays within the limit boundary.

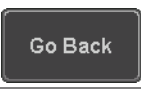
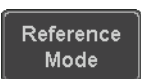

Exit: Sets the NoGo condition to when the input signal exceeds the limit boundary.

	<p>2. Press <i>Go Back</i> to return to the previous menu.</p>	
<p>Set Go-NoGo Actions</p>	<p>3. Press <i>Violating</i> to set what action to perform when a signal violates the Go-NoGo conditions.</p>	
	<p> The waveform stops when the conditions are violated.</p>	
	<p> Ignore violations and continue to monitor the signal. Each violation is counted.</p>	
	<p>4. Press <i>Go Back</i> to return to the previous menu.</p>	
<p>Set Go-NoGo Source</p>	<p>5. Press <i>Compare Source</i> from the bottom menu to set the Go-NoGo boundary source.</p>	
	<p> Sets CH1 as the source.</p>	
	<p> Sets CH2 as the source.</p>	
	<p> Sets CH3 as the source.</p>	
	<p> Sets CH4 as the source.</p>	
	<p>6. Press <i>Go Back</i> to return to the previous menu.</p>	
<p>Set Boundary Tolerance</p>	<p>7. To set the Go-NoGo boundary tolerance, press <i>Reference Mode</i>.</p>	

Auto Tolerance

8. To set the boundary tolerance as a percentage offset from the source waveform, press *Auto Tolerance* and use the Variable knob.



Offset 0.4% ~ 40% (.4% steps)

Maximum and Minimum Position

9. To manually set the template tolerance, press *Minimum Position* or *Maximum Position* and use the Variable knob to set the absolute minimum or maximum position.



or



Range Voltage division range

Save Boundary Template

10. Press *Save Operation* to save the tolerance boundaries.

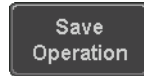

11. The Maximum Position tolerance will be saved to reference waveform R1, and the Minimum Position tolerance to R2.

12. Press *Go Back* to return to the previous menu.

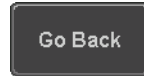

Start Go-NoGo

Press *Enable* to start the Go-NoGo test. Then the Enable button will change to Disable. Pressing *Disable* will stop the Go-NoGo test and toggle the button back to Enable.

If the Violating setting was set to Stop, press *Enable* to restart the test after it has stopped.

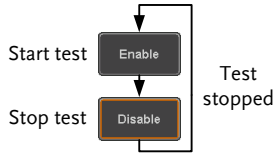

Results

When Go-NoGo is running, the violation/test ratio is displayed in the bottom left-hand corner. The first digit represents the number of violations, and the right hand digit represents the number of tests.

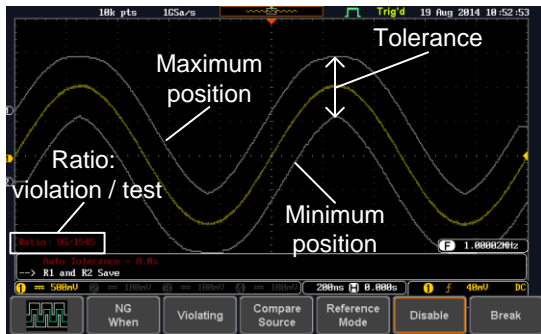

Exit the Application

To exit the application, press *Break*.

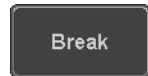

 Note

After you exit the Go/NoGo app, the boundary templates that were saved to R1 & R2 reference waveforms will still be turned on. See page 301 to turn the reference waveforms off.

Using the Go-NoGo Output

To output the Go-NoGo results to an external device, the Go-NoGo rear panel terminal (open collector) can be used. The Go-NoGo terminal will output a positive pulse each time a NoGo violation has occurred for a minimum of 500us. The voltage of the pulse depends on the external pull-up voltage.



Timing Diagram

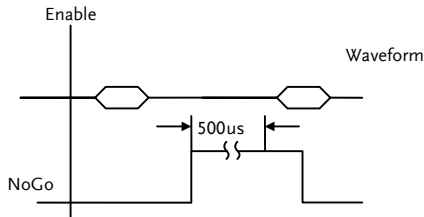

Circuit Diagram

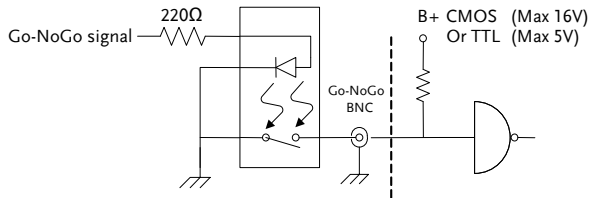

DVM application

Background

The DVM app is a digital voltage meter or digital current meter readout that floats on the top left-hand side of the screen. However, please note that if the cursors (refer to page 60) are turned on, the DVM readout will be replaced by the cursor readout.

The DVM app allows you to measure the AC RMS, DC, DC RMS, Duty and frequency of an input signal. This software is especially useful for those measurement applications that require both a DSO and a basic DVM to be used at the same time.

Basic Features:

- 300V input (peak AC + DC) CAT 1
- 3 digit resolution for voltage measurements
- 5 digit resolution for frequency
- Input channel selection

Example

DVM function indicator

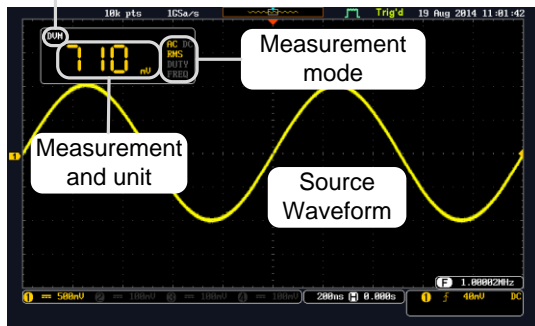

Panel Operation Choose the DVM application from the APP menu. See page 255.



Set Source

1. Press *Source* and select the source channel for the DVM. The probe type setting (voltage or current) determines whether the function acts as a digital voltmeter or as a digital current meter for the selected source. See page 115 to set the probe type.



Source CH1 ~ CH4

Mode

The Mode setting determines the measurement mode for the meter.

2. Press *Mode* and select the mode.



Mode AC RMS, DC, DC RMS, Duty, Frequency

Turn On/Off

3. Press *DVM* and toggle DVM on.



The DVM app will remain running in the background even if other functions are turned on.

Data Log application

Background The Data Log app will log the current waveform data or screenshot at set intervals for a set duration of time.

Basic Features:

- Log up to 1000 hours of images or waveform data.
- The minimum interval is 2, or 5 seconds, and the Interval time needs to be lengthened because of the longer memory length. If you use the USB flash drive to store data, it may require a longer interval which depends on the storing data speed of the USB flash drive.

Example

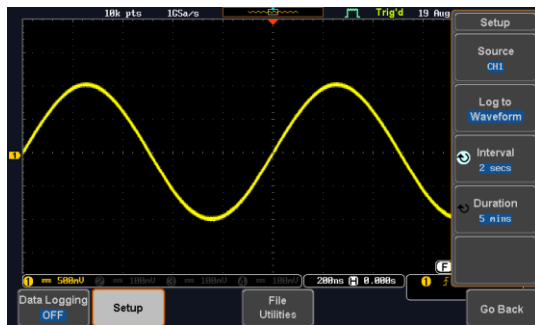

Panel Operation Choose the Data Log application from the APP menu. See page 255.



1. Press *Setup*.



2. Press *Log to* from the side menu and select what type of data to log, waveform data or screenshots.

Log to
Image

Log to Image, Waveform

3. Press *Source* from the side menu and select a source channel to log if waveforms are to be logged.

Source
CH1

Source CH1 ~ CH4, All Displayed

4. Press *Interval* and set the logging interval time.

Interval
00:00:05.000s

Interval Data: 2sec ~ 23h59m59.5s
Image: 5sec ~ 23h59m59.5s

5. Press *Duration* and select the logging duration time.

Duration
00:05:00.000s

Duration 5sec ~ 999h59m59.5s

6. From the bottom menu, press *File Utilities* and set the save file path. See the File Utilities chapter (page 303) for details.

File
Utilities

- Turn On/Off
7. Press *Data Logging* from the bottom menu and toggle Data Logging on.

Data Logging
ON

The data/images will be saved to the designated file path when Data Logging is turned on.

- Set File Path
8. Press *File Utilities* to set the file path. Page 303

Digital Filter application

Background The Digital Filter app is a digital high, low, band pass filter with a selectable cutoff frequency. The digital filter can be applied to analog channel individually or together using the tracking functionality.

Basic Features:

- high, low, band pass filtering of analog channels.
- Selectable cutoff frequencies.
- Tracking function

Example

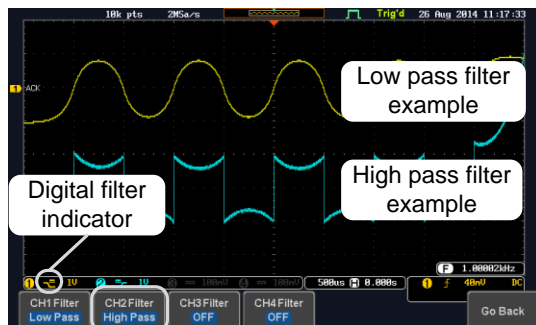

Digital filter
type or status

CH1 input: 2Vpp 1kHz square wave, low pass filter with 1kHz cutoff frequency.

CH2 input: 2Vpp 1kHz square wave, high pass filter with 1kHz cutoff frequency.

Panel Operation Choose the Digital filter application from the APP menu. See page 255.



Set Source

1. Select a source channel by pressing *CH1Filter*, *CH2 Filter*, *CH3 Filter* or *CH4 Filter*.



2. From the side menu press *Filtering* and turn on.

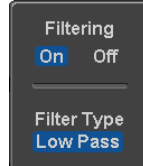

3. Press *Filter Type* and select low, high, or band pass filter.

Type Low Pass, High Pass, Band Pass

4. If Low Pass was selected, press *Upper Limit* to set the low pass cutoff frequency. Likewise if High Pass was selected, press *Lower Limit* to set the high pass cutoff frequency. Only one option will be available at a time.

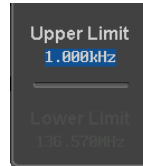

Upper Limit 1Hz ~ 500MHz

Lower Limit 1Hz ~ 500MHz

Tracking

5. Press *Tracking* if you want the settings of the digital filter on each channel to be the same. When a setting is changed on one channel, it is reflected on the other channels.

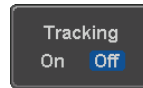

Note

The digital filter settings will still apply to the relevant input signals after leaving the app, unless turned off.

Mask application

Background The Mask application allows the user to create shape templates for easy comparison of an input signal with a defined shape.

Panel Operation Choose the Mask application from the APP menu. See page 255.



Select the source channel

Step 1. Press the *Compare Source* button from the bottom menu.



2. Press the CH1 button from the side menu and use the *Variable* knob to select a source channel (CH1, CH2 for 2 channels models and CH1~CH4 for 4 channels models) as a compare source.



VARIABLE

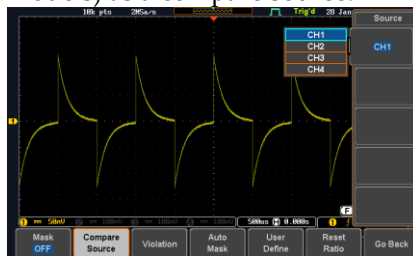

Configure the mask violation

Step

1. Press the *Violation* button from the bottom menu.
2. Press the *Stop* button to stop the data acquisition and freeze the screen when the source waveform crosses the mask boundary (mask violation condition). Conversely, press the *Continue* button to continue acquiring data even when a mask violation condition is encountered.
3. Toggle the *Save* button to *On* will save a file each time a mask violation condition is encountered (see above). The save mode (file type) depends on the hardcopy save setting (see page 310).

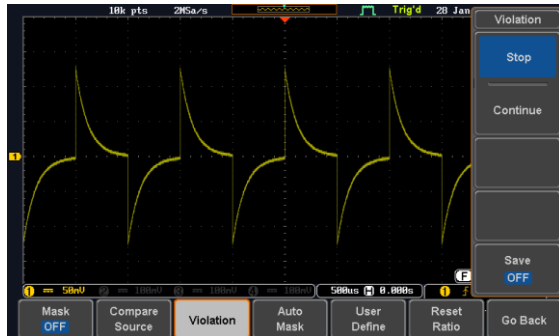
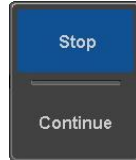
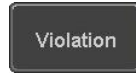

Auto Mask

Step

1. Press the *Auto Mask* button from the bottom menu to create a mask shaped out from an existing waveform. 
2. Press the *Reference Source* button from the side menu to select the pattern the mask will be shaped on.
3. Use the *Variable* knob to select the reference source (CH1 or CH2 for 2 channels model and CH1~CH4 for 4 channels models).

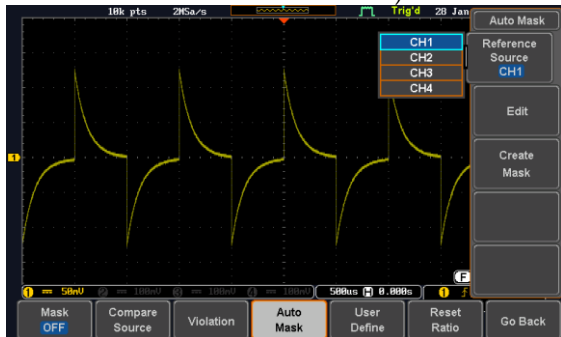

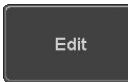
4. Press the *Edit* button from the side menu if you want to further adjust the mask pattern. Otherwise, go to step 9 below to create the mask directly without adjustment. 
5. Press the *Unit* button from the side menu and use the *Variable* knob to select either *Divisions* (graticule division fractions) or *Current* (X or Y axis actual scale units) as the units to set the mask deviation from its original pattern.

- Press the *X Mask* button from the side menu and use the *Variable* knob to adjust the horizontal deviation of the mask compared to its original pattern

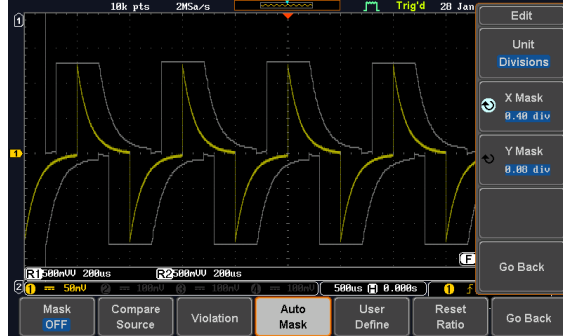

- Press the *Y Mask* button from the side menu and use the *Variable* knob to adjust the vertical deviation of the mask compared to its original pattern.

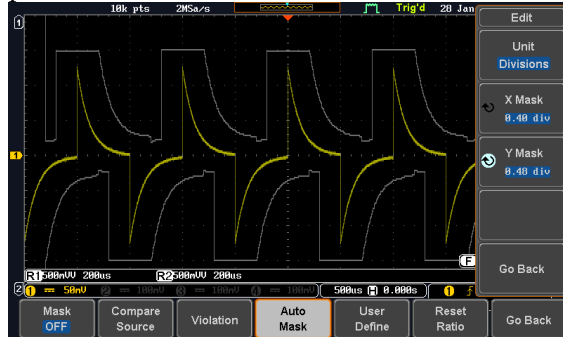

- Press the *Go Back* button from the side menu.

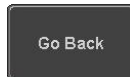

- Press the *Create Mask* button from the side menu.



A mask is created (as shown in the below diagram) and can now be used.

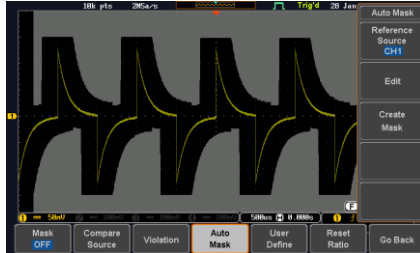

- Press the *Auto Mask* button from the bottom menu to close auto mask function.



- Press the *Mask ON* button from the bottom menu to execute the mask function and start comparing the source channel (set in the compare source menu) with the mask.

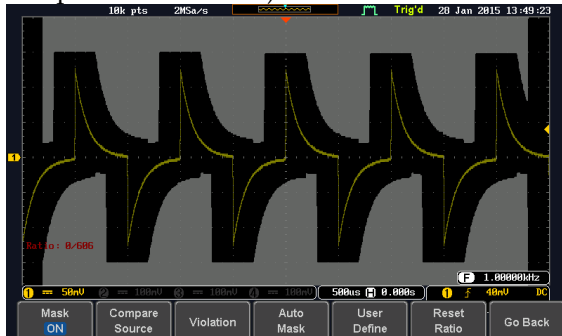

User Defined Mask / Create Mask

Background A user-defined mask can be created. Up to 8 areas of any form, each made of up to 10 points, can be built out and juxtaposed to each other to form the user-defined mask pattern.

Step

1. Press the *User Define* button from the bottom menu.

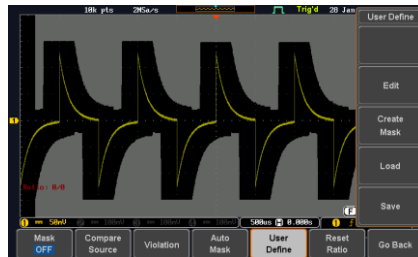

User Define

2. Press the *Edit* button from the side menu.

Edit

Create an area

3. Press the *Area Number* button from the side menu and use the *Variable* knob to select 1 out of 8 areas that can be created to build the mask pattern and start to shape it.



4. Press the *Unit* button from the side menu and use the *Variable* knob to either select *Divisions* (graticule division fractions) or *Current* (Actual oscilloscope X- and Y-axis scale units) as the points position units.
5. Press the *Edit Points* button from the side menu to start shaping the pattern of the area you selected.



- Edit the first point
6. Press the *Points Number* button from the side menu and use the *Variable* knob to select the first point that will shape the area pattern. Up to 10 points can form an area pattern.
 7. Press the *Points Number ON* button from the side menu to activate the point.
 8. Press the *Y Mask* button from the side menu and use the *Variable* knob to adjust the vertical position of the point (Y-axis).
 9. Press the *X Mask* button from the side menu and use the *Variable* knob to adjust the horizontal position of the point (X-axis).

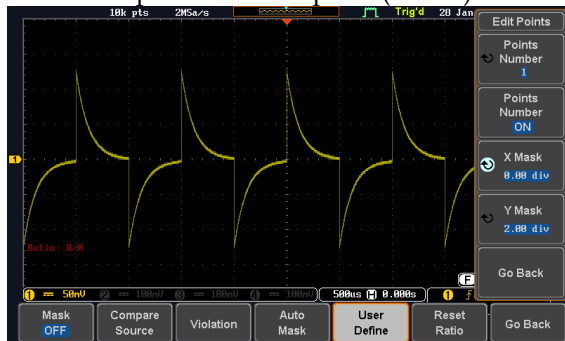

Edit the other points

- Repeat the above steps 6 to 9 to add other points to the area and until you finalize the shape of this first area. Then press the *Go Back* button to exit the Edit Points menu.

Create other areas

- Repeat the above steps for as many areas as you need to create your mask pattern.

- Press the *Go Back* button again from the side menu.

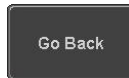

- Press the *Create Mask* button from the side menu.



A user-defined mask is created (as shown in the below diagram) and can now be used.

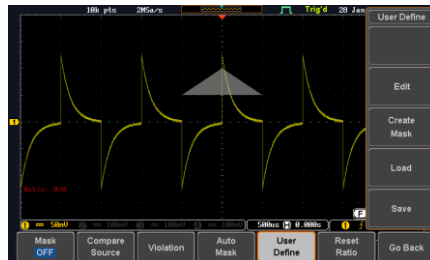

Save the user-defined mask

- Press the *Save* button from the side menu.

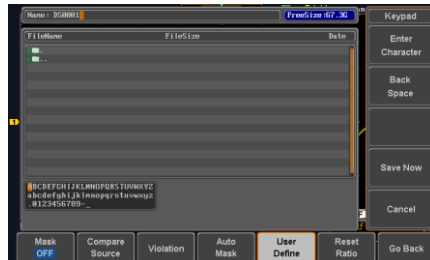
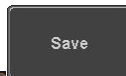

15. Use the variable knob and the select key to change the name of the file if needed and press the *Save Now* button from the side menu to save the user-defined mask.

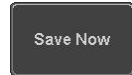

Load a user-defined mask

16. From the User Define menu, you can also load an existing mask. Press the *Load* button from the side menu, use the *Variable* knob to select the file, and press the *Select* key twice to load the mask.

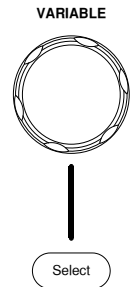
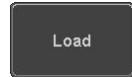

User-defined Mask File Format

Background

The user-defined mask files can be created out of support (from an external computer for example) and uploaded to the MDO-2000EG/2000EX Mask application with a USB flash disk.

Create an unformatted text file respecting the format described below.

File extension

File_name.MSK

Format	Format,2.0E, Total Area Number,1, Area Number,1, Points Number,3, 0.00,2.00, 1.00,1.00, -1.00,1.00,
--------	---

Example (with Division units)	Format,2.0E, Total Area Number,2, Area Number,1, Points Number,4, 0.00,2.00, 1.00,1.00, 0.00,0.00, -1.00,1.00, Area Number,2, Points Number,3, 0.00,-2.00, 1.00,-1.00, -1.00,-1.00,
-------------------------------------	---

SAVE/RECALL

File Format/Utility	278
Image File Format	278
Waveform File Format	278
Spreadsheet File Format	279
Setup File Format	281
Create/Edit Labels	284
Save	287
File Type/Source/Destination	287
Save Image	288
Save Waveform	290
Save Setup	292
Recall	295
File Type/Source/Destination	295
Recall Default Panel Setting	296
Recall Waveform	298
Recall Setup	299
Reference Waveforms	301
Recall and Display Reference Waveforms	301

File Format/Utility

Image File Format

Format	*.bmp or *.png
Default Filename	DSxxxx.bmp/png
Contents	The display image is 800 by 480 pixels. The background color can be inverted (Ink saver function). Each image file is saved to the current file path as a bitmap or PNG file.

Waveform File Format

Format	DSxxxx.lsf, CH1~CH4.lsf	
	The LSF file format efficiently stores waveforms. This is the file format used for storing and recalling all waveforms that are used with the MDO-2000EG/2000EX series.	
Filename	DSxxxx.lsf	
Waveform Type	CH1 ~ 4	Input channel signal
	REF	Reference waveform
	Math	Math operation result (page 67)
Storage Location	Wave1 ~ Wave20	Waveform files stored to the internal memory. Stored waveforms can be transferred to Ref. 1 ~ 4 to be viewed on the display. (W1 ~ W20 waveforms cannot be directly recalled on the display).

Ref 1~4 Reference waveforms stored in the internal memory, separate from W1 ~ W20. Reference waveforms (Ref 1 ~ 4) can be displayed directly onto the display with amplitude and frequency information. Ref 1~4 are useful for reference purposes. Other waveforms (LSF and W1~20) must be recalled to R1~4 before being displayed.

Contents:
Waveform Data The waveform data can be used for detailed analysis. It consists of the horizontal and vertical data used by the waveform.

Spreadsheet File Format

Format *.csv (Comma-separated values format, can be opened in spreadsheet applications such as Microsoft Excel).

CSV-formatted files can be stored in either a short-memory format or a long-memory format: Detail CSV, Fast CSV. The number of points that are saved depends on the record length settings.

Detail CSV will record both the horizontal and vertical sample points of the waveform. All the points are recorded in scientific notation for analog data.

Fast CSV will only record the vertical amplitude of the sample points. Fast CSV also contains data that enables the horizontal data points to be reconstructed, such as trigger position, etc. Data is recorded as integers.

Note, however, that only fast CSV can be recalled to the internal memory. Detailed CSV cannot be recalled.

Filename DSxxxx.csv

Waveform Type	CH1 ~ 4	Input channel signal
	Ref1~4	Reference waveform
	Math	Math operation result (page 67)
	All Displayed	All the waveforms on the display.

Contents:
Fast CSV The following information is included in the Fast CSV waveform files, where applicable:

- Format (scope type)
- IntpDistance (input trigger distance)
- Trigger level
- Vertical units
- Vertical units extend div
- Probe type
- Vertical scale
- Horizontal units
- Horizontal position
- SincET mode (sampling mode)
- Horizontal old scale
- Firmware
- Mode
- Memory length
- Trigger address
- Source
- Vertical units div
- Label
- Probe ratio
- Vertical position
- Horizontal scale
- Horizontal mode
- Sampling period
- Horizontal old position
- Time
- Raw vertical waveform data

Contents:	Detail CSV waveform data contains channel information such as vertical and horizontal position of a signal for all the recorded points.
Detail CSV	<p>The following information is included in Detail CSV, where applicable:</p> <ul style="list-style-type: none"> • Format (scope type) • IntpDistance (input trigger distance) • Trigger level • Vertical units • Vertical units extend div • Probe type • Vertical scale • Horizontal units • Horizontal position • SincET mode (sampling mode) • Horizontal old scale • Firmware • Mode • Horizontal data • Memory length • Trigger address • Source • Vertical units div • Label • Probe ratio • Vertical position • Horizontal scale • Horizontal mode • Sampling period • Horizontal old position • Time • Raw vertical waveform data • Vertical data

Setup File Format

Format	<p>DSxxxx.set (proprietary format)</p> <p>The setup file saves or recalls the following settings.</p>
--------	---

Contents	Acquire	<ul style="list-style-type: none"> • Mode • Sample rate • XY 	<ul style="list-style-type: none"> • Sample mode • Record Length
	Display	<ul style="list-style-type: none"> • Mode • Persistence • Waveform intensity • Graticule intensity 	<ul style="list-style-type: none"> • Backlight intensity • Graticule • Backlight • Auto-dim
	Channel	<ul style="list-style-type: none"> • Scale • Channel • Coupling • Impedance • Invert • Bandwidth 	<ul style="list-style-type: none"> • Expand • Position • Probe • Probe attenuation • Deskew
	Cursor	<ul style="list-style-type: none"> • Horizontal cursor • H Unit 	<ul style="list-style-type: none"> • Vertical cursor • V Unit
	Measure	<ul style="list-style-type: none"> • Source • Gating • Statistics 	<ul style="list-style-type: none"> • Display • High-Low • Reference levels
	Horizontal	<ul style="list-style-type: none"> • Scale 	
	Math	<ul style="list-style-type: none"> • Source1 • Operator • Source2 	<ul style="list-style-type: none"> • Position • Unit/Div • Math Off
	FFT Math	<ul style="list-style-type: none"> • Source • Vertical Units • Window 	<ul style="list-style-type: none"> • Vertical position • Horizontal position

Advanced Math	<ul style="list-style-type: none"> • Expression • VAR1 • VAR2 	<ul style="list-style-type: none"> • Position • Unit/Div
Trigger	<ul style="list-style-type: none"> • Type • Source • Coupling • Alternate • Rejection • Noise Rejection 	<ul style="list-style-type: none"> • Slope • Level • Mode • Trigger When • Timer • Holdoff
Utility	<ul style="list-style-type: none"> • Language • Hardcopy key • File Format 	<ul style="list-style-type: none"> • Ink Saver • Assign Save • Probe Comp.
Save/ recall	<ul style="list-style-type: none"> • Image file format 	<ul style="list-style-type: none"> • Data file format

Create/Edit Labels

Overview Reference files, Setup files and the analog and digital input channels can have individual file labels set.

For the analog channels and reference waveforms, the file label can be displayed next to the channel/reference indicator.

The file labels are also used to easily identify reference files, setup files or channels when saving or recalling waveforms and setups.

Example

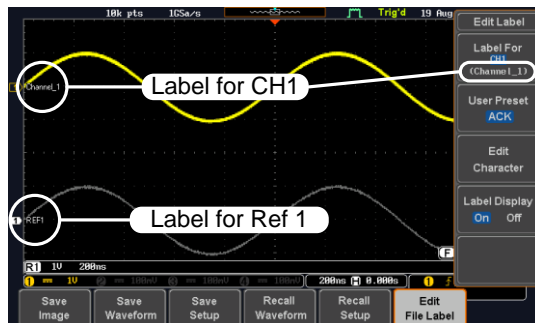

In the example above, the file label for channel 1 is displayed next to the channel indicator and is also displayed in the *Edit Label* menu. The Ref_1 file label is shown next to the reference indicator.

- Panel Operation**
1. Press the *Save/Recall* key from the front panel.
 2. Press *Edit File Label* from the bottom menu.

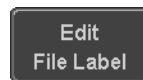

3. Press *Label For* and select the item that you want to create the label for.



Label For CH1~CH4, Ref1~4, Set1~20, Math

4. To choose a preset label, Press *User Preset* from the side menu and choose a label.



Labels ACK, AD0, ANALOG, BIT, CAS, CLK, CLOCK, CLR, COUNT, DATA, DTACK, ENABLE, HALT, INT, IN, IRQ, LATCH, LOAD, NMI

Edit Label

5. Press *Edit Character* to edit the current label.

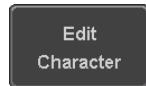

6. The Edit Label window appears.

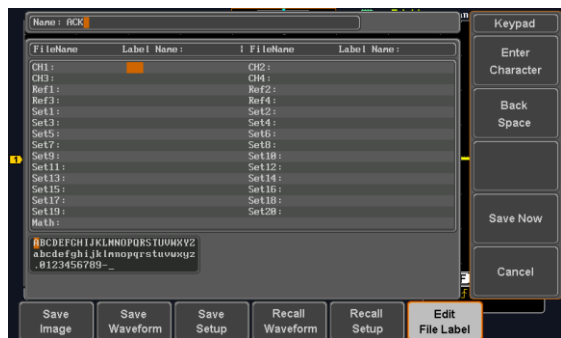

7. Use the Variable knob to highlight a character.



Press *Enter Character* to select a number or letter.

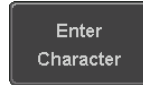

Press *Back Space* to delete a character.



Press *Save Now* to save the label and return to the previous menu.

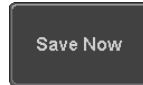

To cancel the editing the label and return to the previous menu, press *Cancel*.

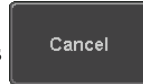

Display Label

To display the currently selected file label on the screen next to its respective indicator, toggle *Label Display* to On.

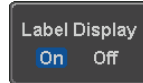

Conversely, if you want to remove the currently selected file label from the display, toggle *Label Display* to Off.

Save

File Type/Source/Destination

Item	Source	Destination
Panel Setup (DSxxxx.set)	<ul style="list-style-type: none"> • Front panel settings 	<ul style="list-style-type: none"> • Internal memory: Set1 ~ Set20 • File system: Disk, USB
Waveform Data (DSxxxx.csv) (DSxxxx.lsf) (CH1~CH4.lsf, Ref1~Ref4.lsf, Math.lsf)* ALLxxxx.csv	<ul style="list-style-type: none"> • Channel 1 ~ 4 • Math operation result • Reference waveform Ref1~4 • All displayed waveforms 	<ul style="list-style-type: none"> • Internal memory: Reference waveform Ref1~4, Wave1 ~ Wave20 • File system: Disk, USB
Display Image (DSxxxx.bmp/png) (Axxx1.bmp/png)**	<ul style="list-style-type: none"> • Display image 	<ul style="list-style-type: none"> • File system: Disk, USB

*Stored in ALLXXXX directories when All Displayed waveforms are saved.

**Stored in ALLXXXX directories when the Hardcopy key is assigned to save Waveform, Setup or All.

Note: By default all filenames/directories are named DSxxxx/ALLxxxx where xxxx is a number starting from 0001 and is incremented by one after each save.

Save Image

Images can be saved either using the Save/Recall key or by using the Hardcopy key. To save images using the Hardcopy key, see the hardcopy section on page 310.

- Panel Operation
1. To save to USB, connect a USB drive to the front panel USB port. If a USB drive is not connected, images can still be saved to the internal memory.

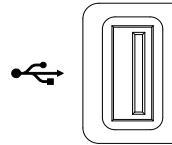

2. Press the *Save/Recall* key from the front panel.



3. Press *Save Image* from the bottom menu.

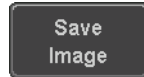

4. Press *File Format* to choose PNG or BMP file types.

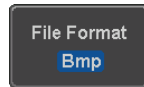

Range DSxxxx.bmp, DSxxxx.png

5. Press *Ink Saver* to toggle Ink Saver On or Off.

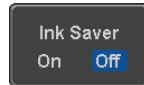

Ink Saver On

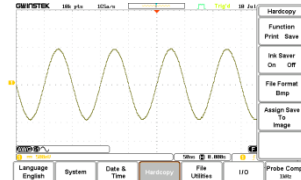

Ink Saver Off

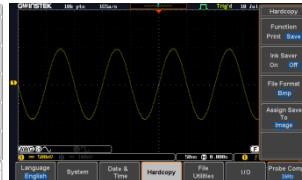

6. Press *Save* from the side menu to save the display as an image file.

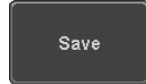

7. You will automatically be taken to a file utility where you will be able to edit the name of the file.

8. To edit the file name, use the *Variable* knob to highlight a character.



Press *Enter Character* or the *Select* key to select a number or letter.

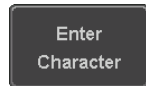

Press *Back Space* to delete a character.



9. Press *Save Now* to save the file. The file name need not have been edited to save the file.

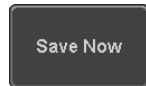

Note: Pressing *Cancel* will cancel the save operation and return you to the *Save/Recall* menu.

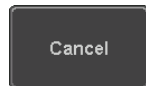

After *Save Now* has been pressed the file will be saved.



Note

The file will not be saved if the power is turned off or the USB drive is taken out before the message ends.

File Utility

To edit the internal memory or the USB flash drive contents (create/delete/rename files and folders) or to edit the default file path, press *File Utilities* from the side menu.



Save Waveform

Panel Operation

1. To save to an external USB flash drive, connect the drive to the front panel USB port. If a USB drive is not connected, files can still be saved to the internal memory.

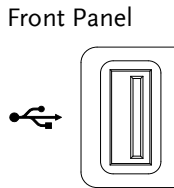

2. Press the *Save/Recall* key from the front panel.



3. Press *Save Waveform* from the bottom menu.



4. Choose the *From* waveform on the side menu.

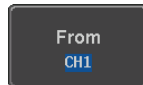

Source CH1~4, Math, Ref1~4, All Displayed

5. Press *To* (internal memory) or *To File* and choose a destination to save.

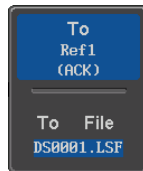

To Ref1~4, Wave1~20

To File Format: LSF, Detail CSV, Fast CSV

6. Press *Save* to save the file.

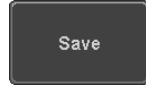

7. If you are saving to a file, a file utility appears where you will be able to edit the name of the file from the default "DSXXX" filename.

8. To edit the filename, use the *Variable* knob to highlight a character.



Press *Enter Character* or the *Select* key to select a number or letter.

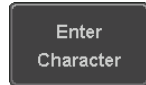

Press *Back Space* to delete a character.

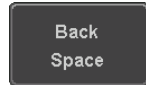

9. Press *Save Now* to save the file. The filename need not have been edited to save the file.

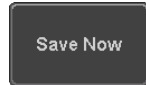

Note: Pressing *Cancel* will cancel the save operation and return you to the *Save/Recall* menu.

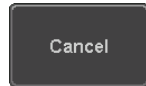

After *Save Now* has been pressed the file will be saved.



Note

The file will not be saved if the power is turned off or the USB drive is taken out before the message ends.

File Utility

To edit the internal memory or the USB flash drive contents (create/delete/rename files and folders), press *File Utilities*.



Save Setup

Panel Operation

1. To saving to an external USB flash drive connect the drive to the front or rear panel USB port. If a USB drive is not connected, files can be saved to the internal memory.

Front Panel

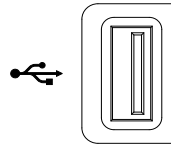

2. Press the *Save/Recall* key from the front panel.

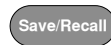

3. Press *Save Setup* from the bottom menu.



4. Press *To* (internal memory) or *To File* and choose a destination to save to.



To Set1~Set20

To File DSxxxx.set

5. Press *Save* to confirm saving. When completed, a message appears at the bottom of the display.



6. If you are saving to a file, a file utility appears where you will be able to edit the name of the file from the default "DSxxxx" filename.

7. To edit the filename, use the *Variable* knob to highlight a character.



Press *Enter Character* or the *Select* key to select a number or letter.

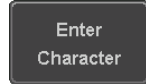

Press *Back Space* to delete a character.

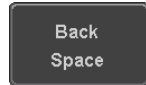

8. Press *Save Now* to save the file. The filename need not have been edited to save the file.

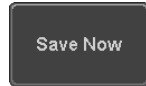

Note: Pressing *Cancel* will cancel the save operation and return you to the *Save/Recall* menu.

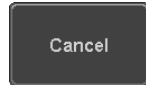

After *Save Now* has been pressed the file will be saved.

Setup saved to USB :/DS0001.SET.



Note

The file will not be saved if the power is turned off or the USB drive is taken out before the message ends.

File Utility

To edit the internal memory or the USB flash drive contents (create/delete/ rename files and folders) or to set the file path, press *File Utilities*.

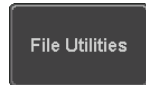

Edit Label

To edit labels for Setup files, press *Edit Label*. For more details on editing labels, see page 284.



Recall

File Type/Source/Destination

Item	Source	Destination
Default Panel Setup	<ul style="list-style-type: none"> Factory installed setting 	<ul style="list-style-type: none"> Current front panel
Reference Waveform	<ul style="list-style-type: none"> Internal memory: Ref1~4 	<ul style="list-style-type: none"> Current front panel
Panel Setup (DSxxxx.set)	<ul style="list-style-type: none"> Internal memory: S1 ~ S20 File system: Disk, USB 	<ul style="list-style-type: none"> Current front panel
Waveform Data (DSxxxx.lsf, DSxxxx.csv**, CH1~CH4.lsf, Ref1~Ref4.lsf, Math.lsf)*	<ul style="list-style-type: none"> Internal memory: Wave 1 ~ Wave20 File system: Disk, USB 	<ul style="list-style-type: none"> Reference waveform 1 ~ 4

*Recalled from ALLXXX directories. Note that Allxxxx.csv cannot be recalled to the oscilloscope.

**Detail CSV files cannot be recalled to the oscilloscope.

Recall Default Panel Setting

Panel Operation 1. Press the *Default* key.



2. The screen will update with the default panel settings.

Setting Contents The following is the default (factory) setting contents.

Acquire	Mode: Sample	XY: OFF
	Record Length: 10k	Expand: By Center
Display	Mode: Vector	Persistence: 240ms
	Waveform intensity: 50%	Graticule intensity: 50%
	Backlight Intensity: 80%	Backlight Auto-dim: On
	Time: 10min	Graticule: full 
Channel	Scale: 100mV/Div	CH1: On
	Coupling: DC	Impedance: 1MΩ
	Invert: Off	Bandwidth: full
	Expand: By Ground	Position: 0.00V
	Probe: Voltage	Probe attenuation: 1x
	Deskew: 0s	
Cursor	Horizontal cursor: Off	Vertical Cursor: Off
Measure	Source: CH1	Gating: Screen
	Display All: Off	High-Low: Auto
	Statistics: Off	Mean & Std Dev
		Samples: 2
	High Ref: 90.0%	Mid Ref: 50.0%
	Low Ref: 10.0%	

Horizontal	Scale: 10us/Div	Position: 0.000s
Math	Source1: CH1	Operator: +
	Source2: CH2	Position: 0.00 Div
	Unit/Div: 200mV	Math Off
FFT	Source: CH1	Vertical Units: dBV RMS
	Window: Hanning	Vertical: 20dB
	Horizontal:5MHz/div	
Advanced Math	Expression: CH1+CH2	VAR1: 0
	VAR2: 1	Position: 0.00Div
	Unit/div: 500mV	
APP	App: Go-NoGo, DVM, Datalog, Mount Remote Disk	
Trigger	Type: Edge	Source: CH1
	Coupling: DC	Alternate: Off
	Noise Rejection: Off	Slope: Positive
	Level: 0.00V	Mode: Auto
	Holdoff: 10.0ns	
Utility	Hardcopy: Save	Ink Saver: Off
	Assign Save To: Image	File Format: Bmp
	Probe Comp.: 1kHz	

Recall Waveform

Panel Operation

1. For recalling from an external USB flash drive, connect the drive to the front or rear panel USB port.

Front Panel

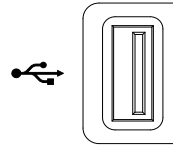

2. The waveform must be stored in advance. See page 290 for waveform store details.
3. Press the *Save/Recall* key.



4. Press *Recall Waveform* from the bottom menu. The Recall menu appears.

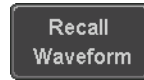

5. Press *From* (internal memory) or *From File* and choose a source to recall from.

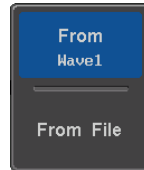

From Wave1~20

From File* File format: Lsf, Fast Csv

*Only files in the current file path will be available, this includes files saved in the ALLxxxx directories.

Allxxxx.csv files cannot be recalled to the oscilloscope.

Only the "Fast CSV", "LSF" files can be recalled to the oscilloscope.

6. Press *To* and select the reference waveform to recall to.

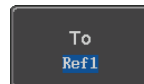

To Ref1~4

7. Press *Recall Now* to recall the waveform. The reference waveform will appear on the screen when successful.

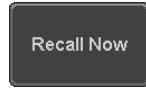

File Utility

To edit USB flash drive contents (create/ delete/ rename files and folders) or to set the file path, press *File Utilities*.



Recall Setup

Panel Operation

1. (For recalling from an external USB flash drive) Connect the drive to the front or rear panel USB port.

Front Panel

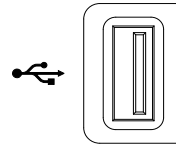

2. Press the *Save/Recall* key.



3. Press *Recall Setup* from the bottom menu.

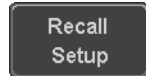

4. Press *From* (internal memory) or *From File* and choose a source to recall from.

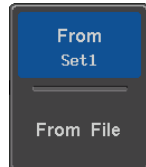

From Set1~20

From File DSxxxx.set (USB, Disk)*

* Only files in the current file path will be available.

5. Press *Recall Now* to confirm recalling. When completed, a message appears at the bottom of the display.

A dark grey rectangular button with rounded corners and the text "Recall Now" in white.An orange rectangular message box with a black border and the text "Setup recalled from Set1." in black.

Note

The file will not be recalled if the power is turned off or the USB drive is taken out before the message appears.

File Utility

To edit the internal memory or the USB flash drive contents (create/ delete/ rename files and folders) or to set the file path, press *File Utilities*.

A dark grey rectangular button with rounded corners and the text "File Utilities" in white.

Edit Label

To edit labels for Setup files, press *Edit label*. For more details on editing labels, see page 284.

A dark grey rectangular button with rounded corners and the text "Edit Label" in white.

Reference Waveforms

Recall and Display Reference Waveforms

Panel Operation A reference waveform must be stored in advance. See page 290 to store waveforms as reference waveforms.

1. Press the REF key on the front panel.



2. Pressing R1~R4 repeatedly will toggle the corresponding reference waveform OFF/ON.



Turning R1~R4 ON will open the corresponding reference menu.

3. If a reference waveform is ON but not active, its reference menu can be opened by pressing the corresponding R1~R4 key from the bottom menu.

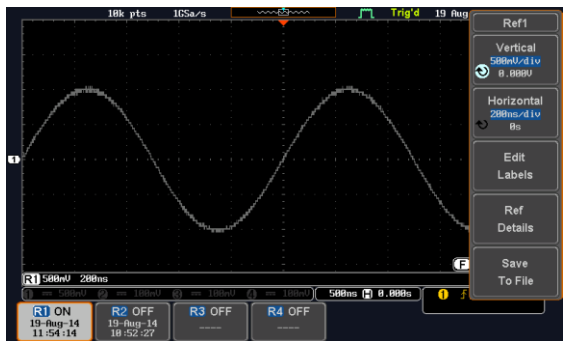

Vertical Navigation

Press *Vertical* repeatedly from the side menu to choose to edit the vertical position or Unit/Div. Use the Variable knob to edit the values.



Horizontal Navigation

Press *Horizontal* repeatedly from the side menu to choose to edit the Time/Div or the horizontal position. Use the Variable knob to edit the value.

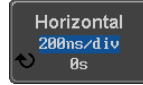

View Reference Waveform Details

Pressing *Ref Details* will display the reference waveform details.

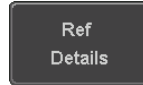

Details: Sample Rate, Record Length, Date

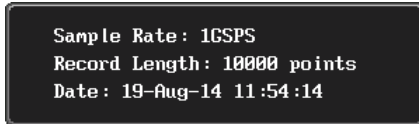

Edit Labels

To edit labels for Setup files, press *Edit Labels*. For more details on editing labels, see page 284.

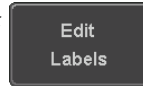

Save Reference Waveforms

To save reference waveforms, press *Save to File*. For more details on saving waveforms, see page 290.

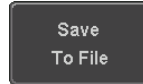

FILE UTILITIES

The file utilities are used each time files need to be saved to internal or external memory. The file utilities can create, delete and rename directories or files as well as copy files from internal memory to USB. The File Utilities menu also sets the file path for saving and recalling files from the Save/Recall menu.

File Navigation	304
Create Folder	306
Rename File.....	307
Delete File or Folder	308
Copy File to USB.....	309

File Navigation

The File Utilities menu can be used to choose files or to set the file path for saving/recalling files.

File System

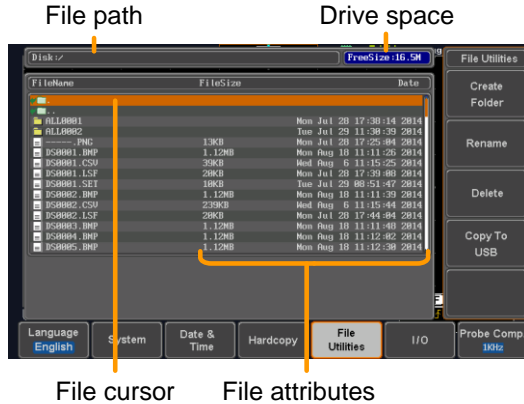

Panel Operation 1. Press the *Utility* key.

Utility

2. Press *File Utilities* from the bottom menu.

File Utilities

3. The file system appears.

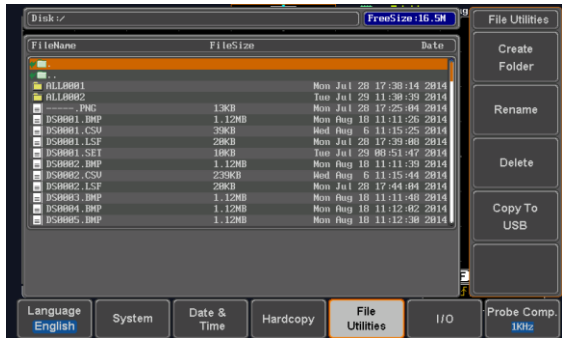

4. Use the *Variable* knob to move the file cursor up and down.

Use the *Select* key to choose a file or directory or to set the file path.

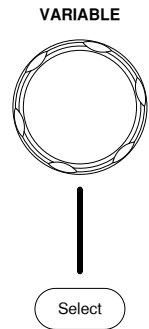

Note

When a USB flash drive is used, the file path is remembered each time the USB flash drive is used. This saves you the hassle of setting the USB file path each time the USB flash drive is inserted into the scope.

Create Folder

Panel Operation 1. Press the *Utility* key.



2. Press *File Utilities* from the bottom menu.



3. Use the *Variable* knob and *Select* key to navigate the file system.

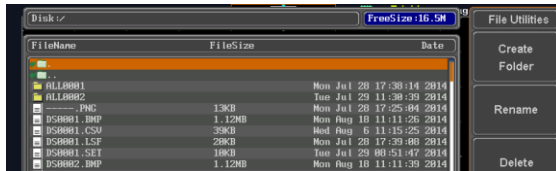

Create Folder

4. Press *Create Folder* to make a new directory at the selected location.



5. Use the *Variable* knob to highlight a character.



Press *Enter Character* or the *Select* key to select a number or letter.



Press *Back Space* to delete a character.



6. Press *Save Now* to create the folder.

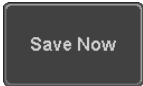

Cancel

Press *Cancel* to cancel the operation.

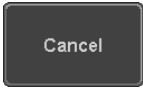

Rename File

Panel Operation

1. Press the Utility key.



2. Press *File Utilities* from the bottom menu.

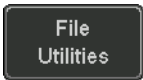

3. Use the Variable knob and select key to choose a file to rename.

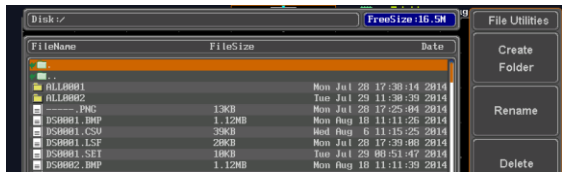

4. Press *Rename* when a file is chosen.

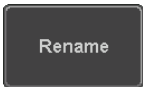

5. Use the *Variable* knob to highlight a character.



Press *Enter Character* or the *Select* key to select a number or letter.

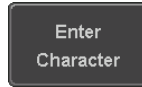

Press *Back Space* to delete a character.

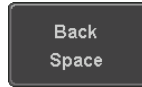

6. Press *Save Now* to rename the folder or file.



Delete File or Folder

- Panel Operation
1. Press the *Utility* key.



2. Press *File Utilities* from the bottom menu.

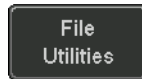

3. Use the Variable knob and select key to navigate the file system to choose a file.

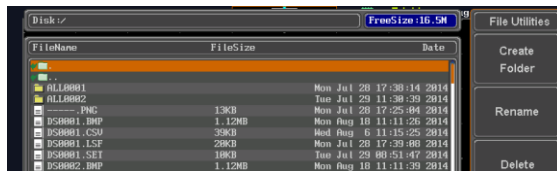

4. Press *Delete* to delete the selected file.

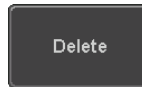

5. Press *Delete* again to confirm the deletion.

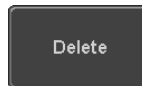

HARDCOPY KEY

The Hardcopy key is used as quick-save or quick-print key. The Hardcopy key can be assigned either to printout screenshots or to save files.

When assigned to “Print” the screen image can be printed to a PictBridge compatible printer using the USB device port. To reduce the amount of printer ink used for each print, images can be printed using the Ink Saver function.

When assigned to “Save”, pressing the Hardcopy key can be used to save a screen shot, a waveform, or the current setup, depending on the configuration.

Printer I/O Configuration

- Panel Operation
1. Connect a PictBridge printer to the USB device port on the rear panel.

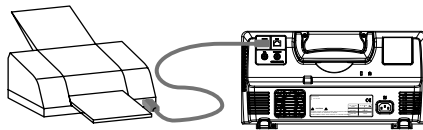

2. Press the *Utility* key.
3. Press *I/O* from the bottom menu.
4. Press *USB Device Port* from the side menu and select *Printer*.

 Utility

 I/O

 USB Device Port
 Printer

Print Output

Ensure the USB port has been configured for the printer and the printer is connected to the scope before trying to print, see page 310.

Panel Operation 1. Press the *Utility* key.



2. Press *Hardcopy* from the bottom menu.

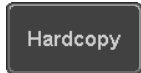

3. On the side menu, press *Function* and select *Print*.

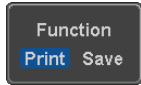

4. Press the *Hardcopy* key to print.
The display image is printed out.



Ink Saver

To have a white background on the printed display image, set *Ink Saver* to On.

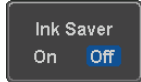

Ink Saver On

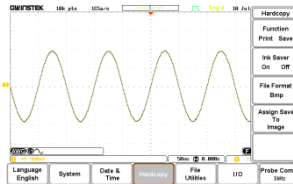

Ink Saver Off

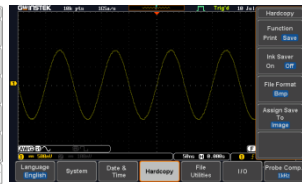

Save - Hardcopy Key

Background When the Hardcopy key is assigned to “Save”, pressing the Hardcopy key can be used to save a screen shot, a waveform, or the current setup, depending on the configuration.

Panel Operation 1. If you wish to save to USB, connect a USB drive to the front panel USB port, otherwise the file will save to internal memory.

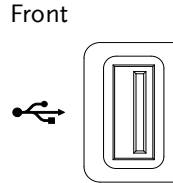

2. Press the *Utility* key.



3. Press *Hardcopy* from the bottom menu.

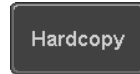

4. On the side menu, press *Function* to select Save.

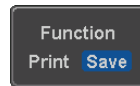

5. Press *Assign Save To* and select which type of file will be saved when the Hardcopy key is pressed.



File Type: Image, Waveform, Setup, All

6. Press the *Hardcopy* key to save the file*.



A message will appear when the save is successful.



Image File Format

- For image files the file format can be selected with the *File Format* key.

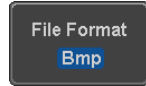

Format: BMP, PNG

Ink Saver

- To have a white background for image files, set *Ink Saver* to On.

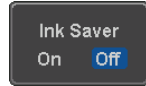

Ink Saver On

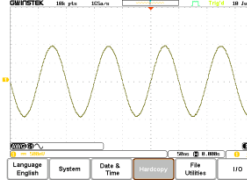

Ink Saver Off

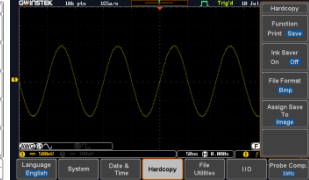

Note

*Each time the Hardcopy key is used to save waveforms or setup files, the files are saved into a new directory. The save directory is labeled ALLXXXX, where XXXX is a number that is incremented with each save. This directory is created in either the internal memory or to a USB flash drive.

REMOTE CONTROL

CONFIG



This chapter describes basic configuration for remote control. For a complete command list, refer to the programming manual downloadable from GW Instek website, www.gwinstek.com.

Interface Configuration	315
Configure USB Interface	315
USB Functionality Check	316
Configure the Ethernet Interface.....	317
Configure Socket Server	319
Socket Server Functionality Check	320

Interface Configuration

Configure USB Interface

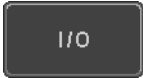
USB Configuration	PC side connector	Type A, host
	MDO-2000EG/ 2000EX side connector	Type B, device
	Speed	1.1/2.0
	USB Class	CDC (communications device class)

- Panel Operation
1. Press the Utility key. 
 2. Press I/O from the bottom menu. 
 3. Press *USB Device Port* from the side menu and select *Computer*. 
 4. Connect the USB cable to the rear panel device port. 
 5. When the PC asks for the USB driver, select the USB driver included on the accompanying User Manual CD or download the driver from the GW Instek website, www.gwinstek.com, in the MDO-2000EG Download section. The driver automatically sets the MDO-2000EG/2000EX as a serial COM port (Shown as VPO in the PORTS node).

USB Functionality Check

Terminal Application

Invoke a terminal application such as RealTerm.

Set the COM port, baud rate, stop bit, data bit, and parity accordingly.

To check the COM port number and associated port settings, see the Device Manager in the PC. For Windows 7:

Control panel → Hardware and Sound → Device Manager

Example: Configuring RealTerm:

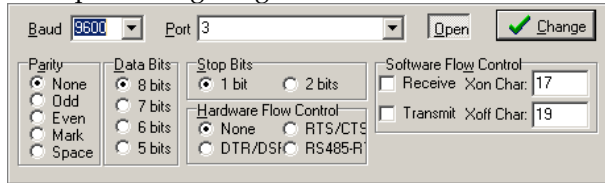

Functionality Check

Key in this query command via the terminal application.

`*!dn?`

This should return the Manufacturer, Model number, Serial number, and Firmware version in the following format.

GW,MDO-2xxxEX,PXXXXXX,V1.00





Note

For further details about remote control and remote commands, please see the programming manual, available on the GW Instek website.

Configure the Ethernet Interface

Ethernet Configuration	MAC Address	Domain Name
	Instrument Name	DNS IP Address
	User Password	Gateway IP Address
	Instrument IP Address	Subnet Mask

Background The Ethernet interface is used for remote control using a socket server connection. For details, please see the Socket Server section on page 319.

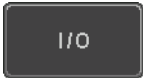
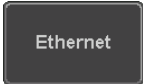
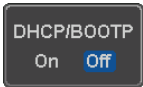
- Panel Operation**
1. Connect the Ethernet cable to the LAN port on the rear panel. 
 2. Press the *Utility* key. 
 3. Press *I/O* from the bottom menu. 
 4. Press *Ethernet* from the side menu. 
 5. Set *DHCP/BOOTP* to *On* or *Off* from the side menu. 

 **Note**

IP addresses will automatically be assigned with DHCP/BOOTP set to on. For Static IP Addresses, DHCP/BOOTP should be set to off.

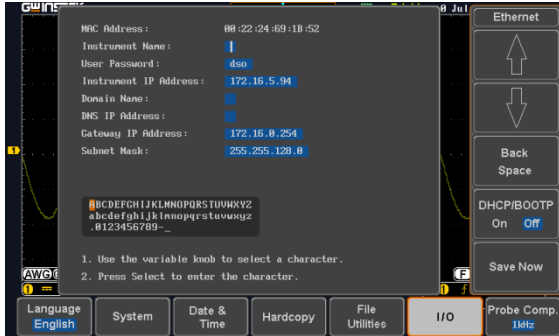

6. Use the *Up* and *Down* arrows on the side menu to navigate to each Ethernet configuration item.

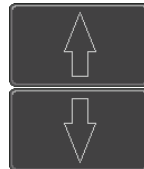

Items MAC Address, Instrument Name, User Password, Instrument IP Address, Domain Name, DNS IP Address, Gateway IP Address, Subnet Mask

7. Use the *Variable* knob to highlight a character and use the *Select* key to choose a character.

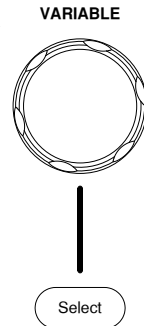

Press *Backspace* to delete a character.



Press *Save Now* to save the configuration. Complete will be displayed when successful.



Configure Socket Server

The MDO-2000EG/2000EX supports socket server functionality for direct two-way communication with a client PC or device over LAN. By default, the Socket Server is off.

Configure Socket Server 1. Configure the IP address for the MDO-2000EG/2000EX. Page 317

2. Press the *Utility* key.



3. Press *I/O* from the bottom menu.

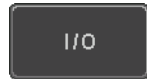

4. Press *Socket Server* from the side menu.

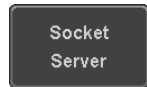

5. Press *Select Port* and choose the port number with the Variable knob.

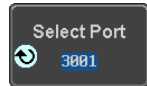

Range 1024~65535

6. Press *Set Port* to confirm the port number.

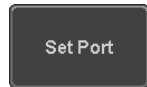

7. The *Current Port* icon will update to the new port number.



8. Press *Server* and turn the socket server On.



Socket Server Functionality Check

NI Measurement and Automation Explorer To test the socket server functionality, National Instruments Measurement and Automation Explorer can be used. This program is available on the NI website, www.ni.com.

- | | | |
|-----------|--|---|
| Operation | 1. Configure the IP address for the MDO-2000EG/2000EX. | Page 317 |
| | 2. Configure the socket port. | Page 319 |
| | 3. Start the NI Measurement and Automation Explorer (MAX) program. Using Windows, press: |  |

Start>All Programs>National Instruments>Measurement & Automation

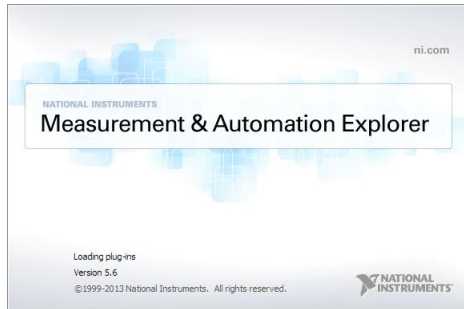

4. From the Configuration panel access;

My System>Devices and Interfaces>Network Devices
5. Right click *Network Devices* and select *Create New Visa TCP/IP Resource...*

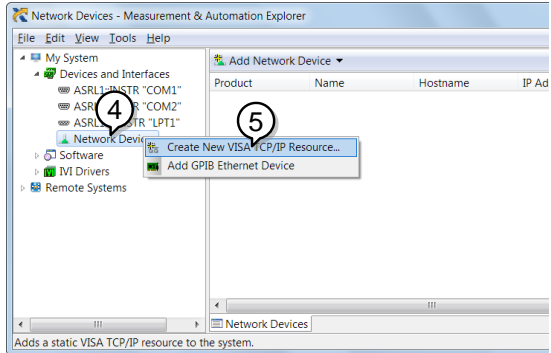

6. Select *Manual Entry of Raw Socket* from the popup window.
7. Click *Next*.

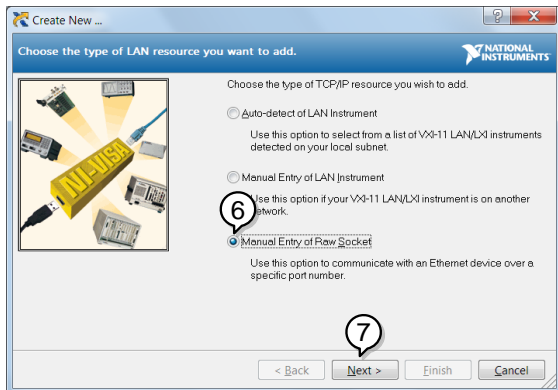

8. Enter the MDO-2000EG/2000EX's IP address and socket port number.
9. Click *Validate*.
10. A popup will appear to tell you if a VISA socket session was successfully created.
11. Click *Next*.

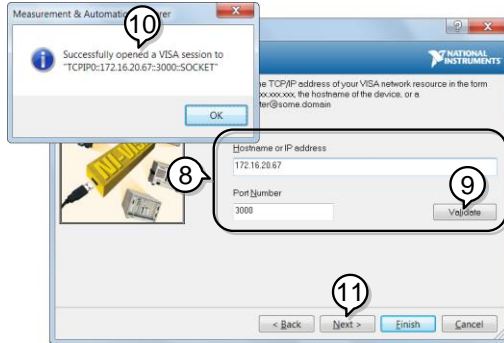

12. Choose an alias for the socket connection if you like.

13. Click *Finish* to finish the configuration.

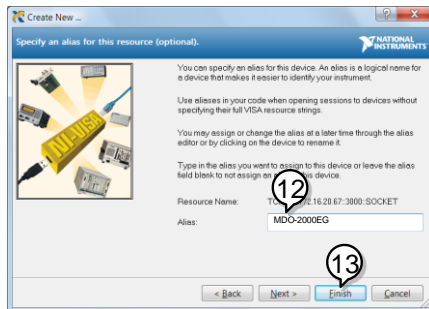

14. The MDO-2000EG/2000EX will now appear under Network Devices in the Configuration Panel.

Functionality
Check

- Click the *Open Visa Test Panel* to send a remote command to the MDO-2000EG/2000EX.

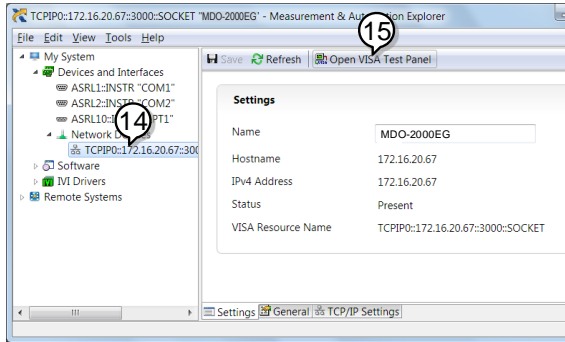

- Click on the *Configuration* icon.

- Select the *I/O Settings* tab.

- Mark the *Enable Termination Character* checkbox. Make sure the termination character is a line feed (/n, value: xA).

- Click *Apply Changes*.

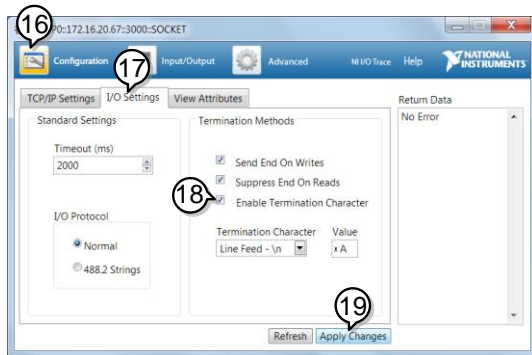

20. Click the *Input/Output* icon.
21. Make sure the **IDN?* query is selected in the *Select or Enter Command* drop box.
22. Click on *Query*.
23. The manufacturer, model number, serial number and firmware version will be displayed in the buffer. For example:
GW,MDO-2202EG,PXXXXXX,V1.00

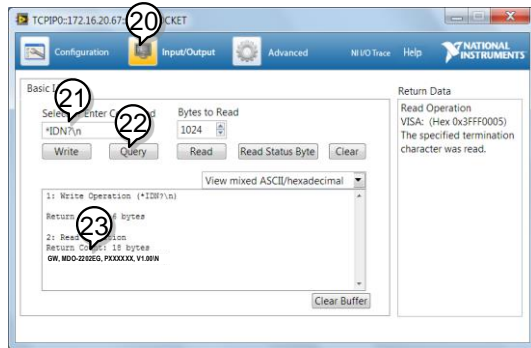

Note

For further details about remote control and remote commands, please see the programming manual.

M AINTENANCE

Three types of maintenance operations are available: Signal Path Compensation, Vertical Accuracy Calibration and Probe Compensation. Run these operations when using the MDO-2000EG/2000EX in a new environment.

How to use the SPC function.....	326
Vertical Accuracy Calibration	327
Probe Compensation.....	328

How to use the SPC function

Background Signal Path Compensation (SPC) is used to compensate the internal signal path due to ambient temperature. SPC is able to optimize the accuracy of the oscilloscope with respect to the ambient temperature.

Panel Operation 1. Press the *Utility* key.



2. Press *System* from the bottom menu.



3. Press *SPC* from the side menu. A message showing a brief introduction to SPC appears on the screen.



Note

Disconnect all probes and cables from all channels before calibrating.

The DSO needs to be warmed up for at least 30 minutes before using the SPC function.



4. Press *Start* on the side menu to start SPC calibration.



5. The SPC Calibration will proceed one channel at a time, from channel 1 to channel 4*.

*Channels 1 to 2 for 2 channel models only.

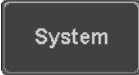
Vertical Accuracy Calibration

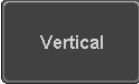
- Panel Operation
1. Press the *Utility* key. 
 2. Press *System* from the bottom menu. 
 3. Press *more 1 of 3* from the side menu. 
 4. Press *Self Cal* on the side menu. 
 5. Press *Vertical* on the side menu. 
 6. A message appears to “Now performing vertical calibration...
CH1
Connect the CAL output to channel, then press the Vertical key”.
 7. Connect the calibration signal from the rear panel to the Channel 1 input with a BNC cable.

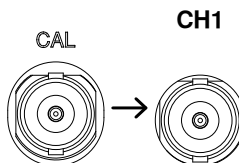

8. Press *Vertical* again after connecting CAL to the channel 1 input.

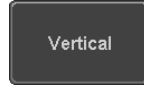

The calibration for Channel 1 starts and ends automatically, in less than 5 minutes. A message is displayed when the calibration procedure has ended.

9. Repeat the above step for Channel 2, 3* and 4* when prompted.

*4 channel models only.

10. When the calibration for all channels has completed, the display goes back to the default state.

Probe Compensation

- Panel Operation
1. Connect the probe between the Channel 1 input and the probe compensation output (default set as 2Vp-p, 1kHz square wave) on the front panel. Set the probe attenuation to x10.
 2. Alternatively, the probe compensation frequency can be changed. See page 184 for details.

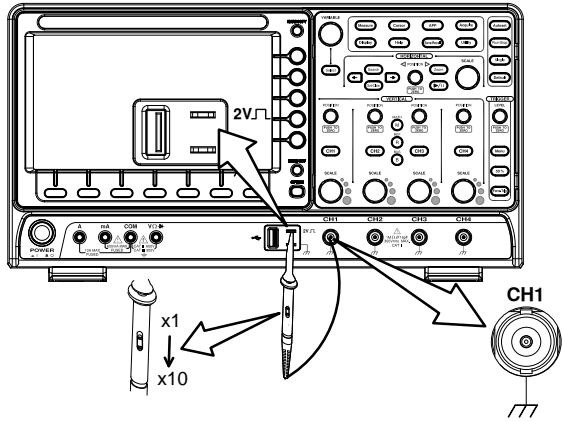

3. Press the *CH1* key to activate CH1.

CH1

4. Set the *Coupling* to DC from the bottom menu.



5. Set the Probe attenuation to *Voltage, 10X*.

Page 116

6. Press the *Autoset* key. The compensation signal appears on the display.

Autoset

7. Press the *Display* key, then set the display type to *Vector*.

Display →

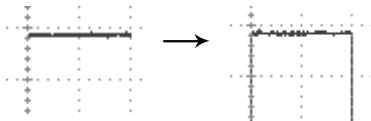

- Turn the adjustment point on the probe to make the waveform as square as possible.

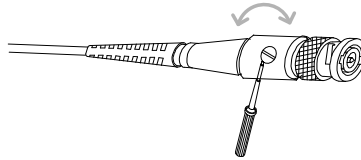
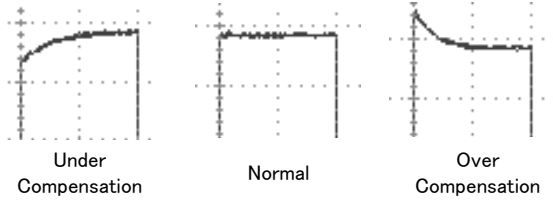

F AQ

- I connected the signal but it does not appear on the display.
- I want to remove the (Measurement result / FFT result / Help contents) from the display.
- The waveform does not update (frozen).
- The probe waveform is distorted.
- Autoset does not catch the signal well.
- The display image printout is too dark on the background.
- The date and time settings are not correct.
- The accuracy does not match the specification.

I connected the signal but it does not appear on the display.

Make sure you have activated the channel by pressing the Channel key (the channel key lights up).

I want to remove the (Measurement result / FFT result / Help contents) from the display.

To clear automatic measurement results, press the Measure key, select Remove Measurement and choose Remove All. See page 52.

To clear individual measurements from the screen, press the Measure key, select Display All and choose Off. See page 54.

To clear the FFT result, press the Math key twice. See page 67 for details.

To clear the Help result, press the Help key again. See page 37 for details.

The waveform does not update (frozen).

Press the Run/Stop key to unfreeze the waveform. See page 42 for details.

If this does not help, the trigger mode might be set to Single. Press the Single key to exit Single mode. See page 143 for Single trigger details.

The probe waveform is distorted.

You might need to compensate the probe. For details, see page 328.

Autoset does not catch the signal well.

The Autoset function cannot catch signals under 10mV or 20Hz. Please use the manual operation. See page 40 for Autoset details.

The display image printout is too dark on the background.

Use the Ink Saver function which reverses the background color. For details, see page 311.

The date and time settings are not correct.

For date and time setting details, please see page 183. If it does not help, the internal battery controlling the clock might be worn out. Contact your dealer or GW Instek.

The accuracy does not match the specification.

Make sure the device is powered On for at least 30 minutes, within +20°C~+30°C. This is necessary to stabilize the unit to match the specification.

For more information, contact your local dealer or GW Instek at www.gwinstek.com / marketing@goodwill.com.tw.

A PPENDIX

Updating the Firmware334

MDO-2000EG/2000EX Specifications.....336

 Model-specific 336

 Common.....337

Probe Specifications342

 GTP-070B-4 342

 GTP-100B-4 342

 GTP-200B-4 343

Dimensions344

Declaration of Conformity.....345

Updating the Firmware

Background New firmware can be downloaded from the GW Instek website in the MDO products section.

Place a copy of the firmware file (xxx.upg) onto the root directory of a USB flash disk.

Panel Operation 1. Put the USB drive that contains the firmware into the front panel USB port.

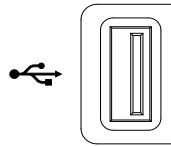

2. Power up the oscilloscope and at the same time, rotating the "VARIABLE" knob several times until the oscilloscope boot in the firmware upgrade mode as in the snapshot below.

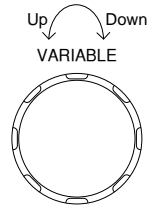

3. When the firmware file of USB flash disk has been recognized by oscilloscope, a message of "Found UPG: xxx.upg" will appear on the lower corner.

4. Press the "Start Now" (F1) key. The oscilloscope will automatically start upgrading the firmware. Or press the "Cancel" (F3) key to quit the firmware upgrading procedure.

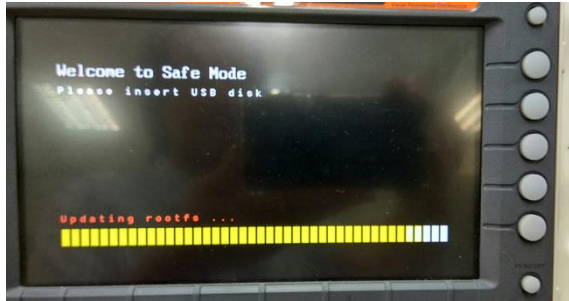

5. When the status indicator shows the complete status (status indicator in yellow completely) and a message of "Update NAND flash success" will appear on the top of status indicator. The firmware upgrading procedure is completed.

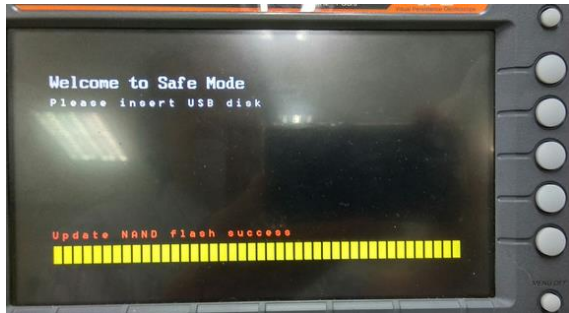

6. Restart the oscilloscope manually. Check the firmware version by pressing the "Utility" → "System" → "System Info". The system information screen that it is being updated.

MDO-2000EG/2000EX Specifications

The specifications apply when the MDO-2000EG/2000EX is powered on for at least 30 minutes under +20°C~+30°C.

Model-specific

MDO-2072EG/ 2072EX	Channels	2 + Ext
	Bandwidth	DC ~ 70MHz (-3dB)
	Rise Time	5ns
	Bandwidth Limit	20MHz
MDO-2074EG/ 2074EX	Channels	4
	Bandwidth	DC ~ 70MHz (-3dB)
	Rise Time	5ns
	Bandwidth Limit	20MHz
MDO-2102EG/ 2102EX	Channels	2 + Ext
	Bandwidth	DC ~ 100MHz (-3dB)
	Rise Time	3.5ns
	Bandwidth Limit	20MHz
MDO-2104EG/ 2104EX	Channels	4
	Bandwidth	DC ~ 100MHz (-3dB)
	Rise Time	3.5ns
	Bandwidth Limit	20MHz
MDO-2202EG/ 2202EX	Channels	2 + Ext
	Bandwidth	DC ~ 200MHz (-3dB)
	Rise Time	1.75ns
	Bandwidth Limit	20MHz/100MHz
MDO-2204EG/ 2204EX	Channels	4
	Bandwidth	DC ~ 200MHz (-3dB)
	Rise Time	1.75ns
	Bandwidth Limit	20MHz/100MHz

Common

Vertical Sensitivity	Resolution	8 bit :1mV*~10V/div *: When the vertical scale is set to 1mV/div, the bandwidth limit will be set to 20MHz automatically.	
	Input Coupling	AC, DC, GND	
	Input Impedance	1M Ω // 16pF approx.	
	DC Gain Accuracy*	1mV: $\pm 5\%$ full scale ≥ 2 mV: $\pm 3\%$ full scale	
	Polarity	Normal & Invert	
	Maximum Input Voltage	300Vrms, CAT I	
	Offset Position Range	1mV/div ~ 20mV/div : ± 0.5 V 50mV/div ~ 200mV/div : ± 5 V 500mV/div ~ 2V/div : ± 25 V 5V/div ~ 10V/div : ± 250 V	
	Waveform Signal Process	+, -, \times , \div , FFT, User Defined Expression FFT: Spectral magnitude. Set FFT Vertical Scale to Linear RMS or dBV RMS or dBm, and FFT Window to Rectangular, Hamming, Hanning or Blackman.	
	Trigger	Source	CH1, CH2, CH3*, CH4*, Line, EXT** *four channel models only. **two channel models only.
		Trigger Mode	Auto (supports Roll Mode for 100 ms/div and slower), Normal, Single Sequence
Trigger Type		Edge, Pulse Width (Glitch), Video, Pulse Runt, Rise & Fall (Slope), Timeout, Alternate, Event-Delay (1~65535 events), Time-Delay (Duration, 4nS~10S), Bus	
Holdoff range		4nS to 10S	
Coupling Sensitivity		AC, DC, LF rej., Hf rej., Noise rej. 1div	
External Trigger	Range	± 15 V	
	Sensitivity	DC ~ 100MHz Approx. 100mV 100MHz ~ 200MHz Approx. 150mV	
	Input Impedance	1M Ω $\pm 3\%$ ~16pF	
Horizontal	Time base Range	1ns/div ~ 100s/div (1-2-5 increments) ROLL: 100ms/div ~ 100s/div	

	Pre-trigger	10 div maximum
	Post-trigger	2,000,000 div maximum.
	Timebase Accuracy	±50 ppm over any ≥ 1 ms time interval
	Real Time Sample Rate	1GSa/s max. (4ch models); 1GSa/s per channel (2ch models)
	Record Length	Max. 10Mpts
	Acquisition Mode	Normal, Average, Peak Detect, Single
	Peak Detection	2nS (typical)
	Average	selectable from 2 to 256
X-Y Mode	X-Axis Input	Channel 1; Channel 3* *four channel models only
	Y-Axis Input	Channel 2; Channel 4* *four channel models only
	Phase Shift	±3° at 100kHz
Cursors and Measurement	Cursors	Amplitude, Time, Gating available; Unit: Seconds(s), Hz (1/s), Phase (degree), Ratio (%).
	Automatic Measurement	38 sets: Pk-Pk, Max, Min, Amplitude, High, Low, Mean, Cycle Mean, RMS, Cycle RMS, Area, Cycle Area, ROVShoot, FOVShoot, RPRESshoot, FPRESshoot, Frequency, Period, RiseTime, FallTime, +Width, -Width, Duty Cycle, +Pulses, -Pulses, +Edges, -Edges, %Flicker, Flicker Idx, FRR, FRF, FFR, FFF, LRR, LRF, LFR, LFF, Phase.
	Cursors measurement	Voltage difference between cursors (ΔV) Time difference between cursors (ΔT)
	Auto counter	6 digits, range from 2Hz minimum to the rated bandwidth
Control Panel Function	Autoset	Single-button, automatic setup of all channels for vertical, horizontal and trigger systems, with undo Autoset
	Save Setup	20set
	Save Waveform	24set
AWG	General	
	Channels	2
	Sample Rate	200MSa/s
	Vertical Resolution	14 bits
	Max. Frequency	25 MHz
	Waveforms	Sine, Square, Pulse, Ramp, DC, Noise Sinc, Gaussian, Lorentz, Exponential Rise, Exponential Fall, Haversine, Cardiac

	Output Range	20 mVpp to 5 Vpp, HighZ; 10 mVpp to 2.5 Vpp, 50Ω
	Output Resolution	1mV
	Output Accuracy	2% (1 kHz)
	Offset Range	±2.5 V, HighZ; ±1.25 V, 50 Ω
	Offset Resolution	1mV
	Sine	
	Frequency Range	100 mHz to 25 MHz
	Flatness	±0.5 dB (relative to 1 kHz)
	Harmonic Distortion	-40 dBc
	Stray (Non-harmonic)	-40 dBc
	Total Harmonic Distortion	1%
	S/N Ratio	40 dB
	Square/Pulse	
	Frequency Range	Square: 100 mHz to 15 MHz
	Rise/Fall Time	< 15ns
	Overshoot	< 3 %
	Duty Cycle	Square: 50% Pulse: 0.4% to 99.6%
	Min. Pulse Width	30ns
	Jitter	500 ps
	Ramp	
	Frequency Range	100 mHz to 1MHz
	Linearity	1%
	Symmetry	0 to 100%
Spectrum Analyzer	Frequency Range	DC~500MHz (Max, Max. bandwidth~500MHz uncalibrated)
	Span	1kHz~500MHz (Max.)
	Resolution Bandwidth	1Hz~500MHz (Max.)
	Reference Level	-50dBm to +40dBm in steps of 5dBm
	Vertical Units	dBV RMS; Linear RMS; dBm
	Vertical Position	-12divs to +12divs
	Vertical Scale	1dB/div to 20dB/div in a 1-2-5 Sequence
	Displayed Average Noise Level	1V/div ← -50dBm, Avg : 16 100mV/div ← -70dBm, Avg : 16 10mV/div ← -90dBm, Avg : 16
	Spurious Response	2nd harmonic distortion < 40dBc 3rd harmonic distortion < 45dBc
	Frequency Domain Trace Types	Normal; Max Hold; Min Hold; Average (2 ~ 256)
	Detection Methods	Sample; +Peak; -Peak; Average

	FFT Windows	FFT Factor: Hanning 1.44 Rectangular 0.89 Hamming 1.30 Blackman 1.68
DMM	Digit Level	5,000 counts CAT II 600Vrms, CAT III 300Vrms
	DC Voltage	
	Range	50mV, 500mV, 5V, 50V, 500V, 1000V, 6 ranges
	Accuracy	50mV, 500mV, 5V, 50V, 500V, 1000V : $\pm(0.1\% + 5 \text{ digits})$
	Input Impedance	10M Ω
	DC Current	
	Range	50mA, 500mA, 10A, 3 ranges
	Accuracy	50mA–500mA : $\pm(0.5\% \text{ reading} + 0.05\text{mA})$; 10A : $\pm(0.5\% + 50\text{mA})$
	AC Voltage	
	Range	50mV, 500mV, 5V, 50V, 500V, 700V, 5 ranges
	Accuracy	50mV, 500mV, 5V, 50V, 700V : $\pm(1.5\% + 15 \text{ digits})$ at 50Hz~1kHz
	* Amplitude greater than 0.2% of the full scale reading.	
	AC Current	
	Range	50mA, 500mA, 10A, 3 ranges
	Accuracy*	50mA, 500mA: $\pm(1.5\% \text{ reading} + 0.05\text{mA})$ at 50Hz~1kHz; 10A: $\pm(3\% \text{ reading} + 50\text{mA})$ at 50Hz~1kHz
	*Measure range: >10mA	
	Resistance*	
	Range	500 Ω , 5k Ω , 50k Ω , 500k Ω , 5M Ω , 5 range
	Accuracy	500 Ω , 5k Ω , 50k Ω , 500k Ω : $\pm(0.3\% \text{ reading} + 3 \text{ digits})$; 5M Ω : $\pm(0.5\% \text{ reading} + 5 \text{ digits})$
	*Measure range: 50 Ω to 5M Ω	
Diode Test	Maximum forward voltage 1.5V, Open voltage 2.8V	
Temperature (Thermocouple)*		
Range	-50°C - + 1000°C	
Resolution	0.1°C	
* Specifications do not include probe accuracy.		
	Continuity Beeper	15 Ω

Power Supply	Output Channel	Ch1 & Ch2
	Output Voltage Range	1.0 V~ 5.0 V
	Output Current (max.)	1 A
	Voltage Step	0.1 V Continuously Adjustable
	Output Voltage Accuracy	+/- 3% (At the device side rather than the load side)
	Ripple and Noise	50mVrms
Display	TFT LCD Type	8" TFT LCD WVGA color display
	Display Resolution	800 horizontal × 480 vertical pixels (WVGA)
	Interpolation	Sin(x)/x
	Waveform Display	Dots, vectors, variable persistence (16ms~4s), infinite persistence
	Waveform Update Rate	120,000 waveforms per second, maximum
	Display Graticule	8 x 10 divisions
	Display Mode	YT, XY
Interface	USB Port	USB 2.0 High-speed host port X1, USB High-speed 2.0 device port X1
	Ethernet Port (LAN)	RJ-45 connector, 10/100Mbps with HP Auto-MDIX
	Go-NoGo BNC	5V Max/10mA TTL open collector output
	Kensington Style Lock	Rear-panel security slot connects to standard Kensington-style lock.
Miscellaneous	Multi-language menu	Available
	Operation Environment	Temperature: 0°C to 50°C. Relative Humidity ≤ 80% at 40°C or below; ≤ 45% at 41°C ~ 50°C.
	On-line help	Available
	Time clock	Time and Date, Provide the Date/Time for saved data
	Dimensions	380mmX208mmX127.3mm
	Weight	3kg

Probe Specifications

GTP-070B-4

Applicable to: MDO-2072EG/2072EX & MDO-2074EG/2074EX

Position x10	Attenuation Ratio	10:1
	Bandwidth	DC to 70MHz
	Input Resistance	10M Ω when used with oscilloscopes with 1M Ω input
	Input Capacitance	14.5pF to 17.5pF
	Compensation Range	10pF to 35pF
	Max. Input Voltage	\leq 600V DC + ACpk
Position x1	Attenuation Ratio	1:1
	Bandwidth	DC to 10MHz
	Input Resistance	1M Ω (oscilloscope input resistance)
	Input Capacitance	85pF to 115pF
	Max. Input Voltage	\leq 200V DC + ACpk
Operating Cond.	Temperature	-10°C to 50°C
	Relative Humidity	\leq 85%

GTP-100B-4

Applicable to: MDO-2102EG/2102EX & MDO-2104EG/2104EX

Position X10	Attenuation Ratio	10:1
	Bandwidth	DC to 100MHz
	Input Resistance	10M Ω when used with oscilloscopes with 1M Ω input.
	Input Capacitance	14.5pF to 17.5pF
	Compensation Range	5pF to 30pF
	Max. Input Voltage	\leq 600V DC + ACpk
Position X1	Attenuation Ratio	1:1
	Bandwidth	DC to 10MHz
	Input Resistance	1M Ω (oscilloscope input resistance)
	Input Capacitance	85pF to 115pF
	Max. Input Voltage	\leq 200V DC + ACpk
Operating Cond.	Temperature	-10°C to 50°C
	Relative Humidity	\leq 85%

GTP-200B-4

Applicable to: MDO-2202EG/2202EX & MDO-2204EG/2204EX

Position X10	Attenuation Ratio	10:1
	Bandwidth	DC to 200MHz
	Input Resistance	10M Ω when used with oscilloscopes with 1M Ω input.
	Input Capacitance	10.5pF to 17.5pF
	Compensation Range	5pF to 30pF
	Max. Input Voltage	$\leq 600V$ DC + ACpk
Position X1	Attenuation Ratio	1:1
	Bandwidth	DC to 10MHz
	Input Resistance	1M Ω (oscilloscope input resistance)
	Input Capacitance	65pF to 105pF
	Max. Input Voltage	$\leq 200V$ DC + ACpk
Operating Cond.	Temperature	$-10^{\circ}C$ to $50^{\circ}C$
	Relative Humidity	$\leq 85\%$

Dimensions

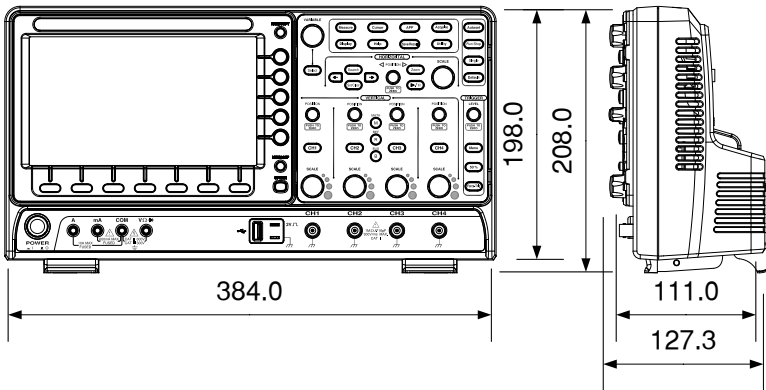
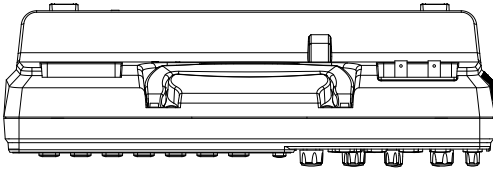

Declaration of Conformity

We

COMBINED TEST SOLUTIONS

declare that the below mentioned product

Type of Product: Mixed-signal oscilloscope

Model Number: MDO-2072EG, MDO-2072EX, MDO-2074EG, MDO-2074EX,
MDO-2102EG, MDO-2102EX, MDO-2104EG, MDO-2104EX,
MDO-2202EG, MDO-2202EX, MDO-2204EG, MDO-2204EX

are herewith confirmed to comply with the requirements set out in the Council Directive on the Approximation of the Law of Member States relating to Electromagnetic Compatibility (2014/30/EU) and Low Voltage Equipment Directive (2014/35/EU).

For the evaluation regarding the Electromagnetic Compatibility and Low Voltage Directive, the following standards were applied:

© EMC	
EN 61326-1 : EN 61326-2-1:	Electrical equipment for measurement, control and laboratory use — EMC requirements (2013)
Conducted and Radiated Emissions EN 55011:2009+A1:2010	Electrical Fast Transients EN 61000-4-4:2012
Current Harmonic EN 61000-3-2:2006+A1:2009+A2:2009	Surge Immunity EN 61000-4-5: 2006
Voltage Fluctuation EN 61000-3-3:2013	Conducted Susceptibility EN 61000-4-6: 2009
Electrostatic Discharge EN 61000-4-2: 2009	Power Frequency Magnetic Field EN 61000-4-8:2010
Radiated Immunity EN 61000-4-3:2006+A1:2008+A2:2010	Voltage Dips/ Interrupts EN 61000-4-11: 2004
Low Voltage Equipment Directive 2014/35/EU	
Safety Requirements	EN 61010-1:2010 (Third Edition) EN 61010-2-030:2010 (First Edition)

INDEX

- AC coupling..... 111
- AC Priority mode 41
- Acquisition 80
 - average80
 - indicator25
 - peak detect.....80
 - record length.....84
 - sample.....80
 - XY mode.....82
- Advanced math
 - expression72
 - operation73
 - source.....72
- Amplitude measurements..... 47
- APP
 - Data Log.....263
 - digital filter265
 - DVM261
 - Go-NoGo.....256
 - mask.....267
 - overview.....254
 - run.....255
- Area measurements 47
- Auto trigger..... 144
- Auto-dim 99
- Automatic measurement
 - Add measurement.....50
 - display all.....54
 - gated mode53
 - High-Low55
 - overview.....46
 - Reference levels58
 - remove measurement52
 - Statistics.....56
- Autoset..... 40
 - AC Priority mode41
 - effect on channel.....41
 - exception41
 - Fit Screen mode41
- AWG
 - AM.....195
 - channel activation.....189
 - connection.....188
 - Coupling and tracking216
 - Create new ARB waveform203
 - edit existing waveform205
 - FM.....197
 - FSK199
 - function edit208
 - impedance190
 - load ARB waveform212
 - normal edit207
 - overview187
 - phase190
 - Save ARB waveform.....214
 - select waveform191
 - specification.....338
 - sweep201
 - turn on output.....190
 - waveform settings192
- Bandwidth filter 113
- Blackman window 70
- Built-in help..... 37
- Bus
 - CAN127
 - cursors138
 - encoding130
 - event tables.....132, 135
 - I²C124
 - labels.....136
 - LIN.....129
 - serial bus overview.....120
 - SPI.....125
 - threshold.....130
 - trigger settings
 - CAN166
 - I²C161
 - LIN.....169
 - SPI.....164

UART	160	horizontal cursor	62
UART	122	vertical cursor	65
Channel	39	File	
status indicator	26	create folder	306
Control panel function		delete	308
specification.....	338	rename.....	307
Conventions	32	File navigation.....	304
Coupling mode	111	File path.....	305
Cursor		Firmware update.....	334
horizontal	60	Firmware version.....	181
specification.....	338	First time use	29
vertical	63	Fit Screen mode	41
Data logging	263	Frequency measurements	48
Date setting.....	183	Front panel diagram	14
indicator.....	25	Go-NoGo	
DC coupling	111	circuit diagram	260
Declaration of conformity.....	345	Go-NoGo	256
Default setup	296	timing	260
contents.....	296	Ground	
effect on channel.....	40	coupling	112
Delay measurements	49	terminal	20
Deskew.....	116	Hamming window	70
Digital filter	265	Hanning window	69
Dimensions		Holdoff	148
diagram.....	344	Horizontal	
Display		basic operation	43
AWG	188	position.....	102
bus	118	scale	103
search.....	172	specification.....	337
segmented memory.....	87	Image file format.....	278
specification.....	341	Impedance.....	112
Spectrum Analyzer.....	222	Initialization.....	29
Dots.....	97	Input frequency indicator	25
DVM.....	261	Intensity.....	98
Edge Trigger.....	149	Interface.....	315
EN61010		specification.....	341
measurement category.....	5	Invert waveform	112
pollution degree.....	6	Keys overview	15
Erase memory	182	Labels.....	284
Ethernet		Language selection	181
interface	317	List of features.....	11
Expand by ground/center.....	114	Mask	267
External trigger	143	auto mask.....	269
input terminal	19	user-defined mask	272
specification.....	337	Math	
FAQ	331	Advanced math overview.....	72
FFT			

basic	67	RMS measurements.....	47
FFT operation.....	70	Roll mode.....	104
FFT overview	69	RS-232C	
Mean measurements	47	function check	316
Memory bar		Run/Stop	42, 100
indicator	25	horizontal position.....	102
Menu on/off	101	Horizontal scale	103
Miscellaneous		Safety Instructions	
specification	341	Caution symbol.....	4
Model differences	10	Cleaning the instrument	6
Normal trigger.....	144	Disposal instructions.....	7
NTSC.....	146	Ground symbol	4
On-screen help	37	Operation Environment.....	6
Overshoot measurements.....	47	Power on/off.....	6
PAL.....	146	UK power cord.....	8
Peak measurements	46	Warning symbol	4
Peak to peak measurement	46	Save.....	287
Persistence	97	hardcopy key.....	312
Play waveform.....	108	image.....	288
Printing		setup	292
connection	310	waveform.....	290
hardcopy key	311	Screen dimmer	99
ink saver	311	Search	
Probe		configuration	172
attenuation level.....	116	copying search events	174
attenuation type	115	copying trigger events.....	174
deskew.....	116	FFT Peak	177
Probe compensation.....	328	navigation.....	174
Probe compensation frequency.....	184	save marks.....	175
Pulse runt trigger.....	155	set/clear events.....	176
Pulse measurements	48	SECAM.....	146
Pulse width trigger.....	152	Segmented memory	
QR code reader function.....	184	configuration.....	87
Rear panel diagram.....	22, 187	infomation	96
Recall.....	295	measurement.....	91
default setup	296	navigation.....	90
reference	301	overview	85
setup	299	play back.....	91
waveform	298	run	88
Rectangular window.....	70	Serial number	181
Reduce any menu	35	Service operation	
Reduce lower menu	35	about disassembly	5
Reduce side menu	34	contact	332
Remote control.....	314	Setup	
interface configuration	315	default contents.....	296
Rise and fall trigger	157	file format	281
		Signal path compensation	326
		Single trigger mode	144

Run/Stop.....	42	mode.....	149
Socket server		parameters.....	143
function check.....	320	pulse runt.....	155
Socket server		pulse width.....	152
interface.....	319	Rise and fall.....	157
SPC.....	326	Single.....	42
Specifications.....	336	specification.....	337
Spectrum Analyzer		status indicator.....	25
bandwidth.....	233	Timeout.....	158
center frequency.....	229	overview.....	147
connections.....	224	video.....	154
cursors.....	237, 242, 243, 244, 245, 246, 247	Updating the firmware.....	334
detection mode.....	228	USB	
Overview.....	221	function check.....	316
peak search.....	236	remote control interface.....	315
source.....	224	Vectors.....	97
span.....	230	Vertical.....	110
start and stop frequency.....	231	accuracy calibration.....	327
trace options.....	225	basic operation.....	45
vertical scale.....	234	position.....	110
window type.....	234	scale.....	111
Spreadsheet file format.....	279	specification.....	337
Stop icon.....	42	Video trigger.....	154
System information.....	181	Waveform	
Tilt stand.....	27	CSV file contents.....	281
Time setting.....	183	file contents.....	279
indicator.....	25	how to recall.....	298
Trigger.....	140	how to save.....	290
Bus		invert waveform.....	112
CAN.....	166	play/pause key.....	108
I ² C.....	161	roll mode.....	104
LIN.....	169	zoom mode.....	106
SPI.....	164	Waveform color.....	24
UART.....	160	Waveform file format.....	278
edge.....	149	XY	
holdoff.....	148	specification.....	338
indicator.....	25	Zoom waveform.....	106

Combined Test Solutions,
4 Commerce Way, Stanbridge Road,
Leighton Buzzard, LU7 4RW

T: 01525 374466
E: sales@ctstest.co.uk
W: www.ctstest.co.uk

